

Vision Sensor FH/FHV Series Vision System

Operation Manual for Sysmac Studio

FH-2□□□/FH-2□□□-□□

FH-5□□□/FH-5□□□-□□

FHV7□-□□□□□-C

FHV7□-□□□□□-S□□/FHV7□-□□□□□-S□□-□□

FHV7□-□□□□□-H□□/FHV7□-□□□□□-H□□-□□



NOTE

- All rights reserved.
- No part of this publication may be reproduced, stored in a retrieval system, or transmitted, in any form, or by any means, mechanical, electronic, photocopying, recording, or otherwise, without the prior written permission of OMRON.
- No patent liability is assumed with respect to the use of the information contained herein. Moreover, because OMRON is constantly striving to improve its high-quality products, the information contained in this manual is subject to change without notice. Every precaution has been taken in the preparation of this manual. Nevertheless, OMRON assumes no responsibility for errors or omissions.

Neither is any liability assumed for damages resulting from the use of the information contained in this publication.

Trademarks

- Sysmac and SYSMAC are trademarks or registered trademarks of OMRON Corporation in Japan and other countries for OMRON factory automation products.
- This software is based in part on the work of the Independent JPEG Group.
- Microsoft, Windows, Windows Vista, Excel, and Visual Basic are either registered trademarks or trademarks of Microsoft Corporation in the United States and other countries.
- Intel, Core and Pentium are trademarks of Intel Corporation in the U.S. and/or other countries.
- EtherCAT® is registered trademark and patented technology, licensed by Beckhoff Automation GmbH, Germany.
- ODVA, CIP, CompoNet, DeviceNet, and EtherNet/IP are trademarks of ODVA.
- The SD, SDHC, microSD, and microSDHC logos are trademarks of SD-3C, LLC.



- QR Code is a registered trademark of DENSO WAVE INCORPORATED.
- MELSEC is a registered trademarks of Mitsubishi Electric Corporation.

Other company names and product names in this document are the trademarks or registered trademarks of their respective companies.

Copyrights

Microsoft product screen shots reprinted with permission from Microsoft.

Introduction

Thank you for purchasing the FH/FHV Series.

This manual contains information that is necessary to use the FH/FHV Series.

Please read this manual and make sure you understand the functionality and performance of the FH/FHV Series before you attempt to use it in a control system.

Keep this manual in a safe place where it will be available for reference during operation.

Intended Audience

This manual is intended for the following personnel, who must also have knowledge of electrical systems (an electrical engineer or the equivalent).

- Personnel in charge of introducing FA systems.
- Personnel in charge of designing FA systems.
- Personnel in charge of installing and maintaining FA systems.
- Personnel in charge of managing FA systems and facilities.

Applicable Products

This manual covers the following products.

- FH-2□□□
- FH-2□□□-□□
- FH-5□□□
- FH-5□□□-□□
- FHV7□-□□□□□-C
- FHV7□-□□□□□-S□□/ FHV7□-□□□□□-S□□-□□
- FHV7□-□□□□□-H□□/ FHV7□-□□□□□-H□□-□□

Part of the specifications and restrictions are given in other manuals. Refer to Relevant Manuals on *Relevant Manuals* on page 2 and *Related Manuals* on page 19.

Relevant Manuals

The following table provides the relevant manuals for the FH/FHV Series.

Read all of the manuals that are relevant to your system configuration and application before you use the FH/FHV Series.

Purpose of use	Manual							
	Basic information			FH Series Smart Camera Setup Manual	FH/FHV Series Vision System Processing Item Function Reference Manual	FH/FZ5 Series Vision System Macro Customize Functions Programming Manual	FH/FHV Series Vision System User's Manual for Communications Settings	FH/FHV Series Vision System Operation Manual for Sysmac Studio
	FH/FHV Series Vision System User's Manual	FH Series Vision System Hardware Setup Manual						
Overview of FH series	●	●						
Overview of FHV series	●		●					
Setup and Wiring								
EtherCAT								
EtherNet/IP								
PROFINET		●	●					
Ethernet								
RS-232C								
Parallel interface								
Setup the communication setting of Sensor Controller								●
EtherCAT								
EtherNet/IP	●	●	●				●	
PROFINET								
Ethernet								
RS-232C								
Parallel interface								
Setup the Sensor Controller								●
EtherCAT								
EtherNet/IP	●						●	
PROFINET								
Ethernet								
RS-232C								
Parallel interface								

Purpose of use	Manual						
	Basic information			FH/FHV Series Vision System Processing Item Function Reference Manual	FH/FZ5 Series Vision System Macro Customize Functions Programming Manual	FH/FHV Series Vision System User's Manual for Communications Settings	FH/FHV Series Vision System Operation Manual for Sysmac Studio
	FH/FHV Series Vision System User's Manual	FH Series Vision System Hardware Setup Manual	FHV Series Smart Camera Setup Manual				
Create and Set the Scene							●
EtherCAT							
EtherNet/IP							
PROFINET	●			●			
Ethernet							
RS-232C							
Parallel interface							
Optimizing the Scene Flow							
EtherCAT							
EtherNet/IP							
PROFINET				●	●		
Ethernet							
RS-232C							
Parallel interface							
Connecting the Controller							●
EtherCAT							
EtherNet/IP							
PROFINET	●	●	●			●	
Ethernet							
RS-232C							
Parallel interface							
Using Helpful Functions							●
EtherCAT							
EtherNet/IP							
PROFINET	●						
Ethernet							
RS-232C							
Parallel interface							
Troubleshooting and Problem Solving	●						

Manual Structure

Page Structure

The following page structure is used in this manual.

The diagram illustrates the structure of a manual page. On the left, annotations point to various elements:

- Level 1 heading:** Points to the page number '4' in the top right corner.
- Level 2 heading:** Points to the section title '4-3 Mounting Units'.
- Level 3 heading:** Points to the sub-section title '4-3-1 Connecting Controller Components'.
- Gives the current headings:** Points to the sub-section title '4-3-1 Connecting Controller Components'.
- Page tab:** Points to the page number '4' in a tab on the right side.
- Gives the number of the main section:** Points to the page number '4' in the tab.
- A step in a procedure:** Points to the number '1' in the first step.
- Indicates a procedure:** Points to the first step '1 Join the Units so that the connectors fit exactly.'
- Special information:** Points to the 'Precautions for Correct Use' section, which includes a warning icon and text about locking sliders.
- Manual name:** Points to the footer text 'NJ-series CPU Unit Hardware User's Manual (W500)'.

 The page content includes:

- Section 4 Installation and Wiring
- Section 4-3 Mounting Units
- Section 4-3-1 Connecting Controller Components
- Text: The Units that make up an NJ-series Controller can be connected simply by pressing the Units together and locking the sliders by moving them toward the back of the Units. The End Cover is connected in the same way to the Unit on the far right side of the Controller.
- Step 1: Join the Units so that the connectors fit exactly. Includes a diagram showing 'Hook', 'Connector', and 'Hook holes'.
- Step 2: The yellow sliders at the top and bottom of each Unit lock the Units together. Move the sliders toward the back of the Units as shown below until they click into place. Includes a diagram showing 'Move the sliders toward the back until they lock into place.', 'Release', 'Lock', and 'Slider'.
- Section: **Precautions for Correct Use** (indicated by a warning icon). Text: The sliders on the tops and bottoms of the Power Supply Unit, CPU Unit, I/O Units, Special I/O Units, and CPU Bus Units must be completely locked (until they click into place) after connecting the adjacent Unit connectors.
- Page number: 4-9

Note This illustration is provided only as a sample. It may not literally appear in this manual.

Special Information

Special information in this manual is classified as follows:



Precautions for Safe Use

Precautions on what to do and what not to do to ensure safe usage of the product.



Precautions for Correct Use

Precautions on what to do and what not to do to ensure proper operation and performance.



Additional Information

Additional information to read as required.

This information is provided to increase understanding or make operation easier.

Sections in This Manual

1	Overview	10	Troubleshooting	1	10
2	Basic Operations	A	Appendices	2	A
3	Connecting with a Vision Sensor	I	Index	3	I
4	Configuring Measurement Settings			4	
5	Designing Exchange with External Devices			5	
6	Online Debugging			6	
7	Offline Debugging			7	
8	Other Useful Functions			8	
9	Limitations			9	

CONTENTS

Introduction	1
Intended Audience	1
Applicable Products	1
Relevant Manuals	2
Manual Structure	4
Page Structure	4
Special Information	5
Sections in This Manual	7
Terms and Conditions Agreement	12
Warranty, Limitations of Liability	12
Application Considerations	13
Disclaimers	13
Safety Precautions	15
Precautions for Safe Use	16
Precautions for Correct Use	17
Regulations and Standards	18
Related Manuals	19
Terminology	21
Revision History	22

Section 1 Overview

1-1 Supported Models	1-2
1-2 Project Management	1-3
1-2-1 Project data	1-3
1-2-2 Project Data Handling in Different System Configurations	1-4

Section 2 Basic Operations

2-1 Basic Design Flow 1	2-3
2-2 Basic Design Flow 2	2-5
2-3 Creating a New Project	2-7
2-3-1 Creating a New Project File from the Project Window	2-7
2-3-2 Adding FH/FHV Device to a Project	2-8
2-3-3 Deleting FH/FHV Device from a Project	2-9
2-4 Description of Screen Components	2-10
2-4-1 Application Window	2-10
2-4-2 Menu Bar	2-10
2-4-3 Toolbar	2-11

2-4-4	Multiview Explorer	2-11
2-4-5	Edit Pane	2-13
2-4-6	Toolbox	2-30
2-5	Basic Operations of Scene Data.....	2-32
2-5-1	Switching Scenes	2-32
2-5-2	Managing Scenes	2-33
2-5-3	Entering Scene Information.....	2-33
2-5-4	Searching for a Scene.....	2-34
2-5-5	Switching Scene Groups	2-34
2-5-6	Managing Scene Groups	2-34
2-5-7	Entering Scene Group Information.....	2-35
2-6	Basic Operations of Flow Editing.....	2-36
2-6-1	Adding a Processing Unit	2-36
2-6-2	Managing Processing Units	2-37
2-6-3	Searching for a Processing Unit.....	2-39
2-7	Function List	2-40
2-7-1	List of Functions Provided with the FH/FHV Tool	2-40
2-7-2	Comparison with FH Series Unit Functions	2-42
2-7-3	Comparison with FHV Series Unit Functions	2-43
2-8	Precautions on Synchronization through an NJ/NX/NY-series Controller	2-45
2-8-1	Synchronized Project Data.....	2-45
2-8-2	Saving and Loading the Settings Data for the FH/FHV Sensor Controller.....	2-46
2-8-3	Transferring Data from the Sysmac Studio	2-47
2-8-4	Transferring Data to the Sysmac Studio	2-48

Section 3 Connecting with a Vision Sensor

3-1	Connecting with a Vision Sensor	3-2
3-2	Adding FH/FHV Series Vision Sensor on the Network to a Project	3-3
3-3	Establishing an Online Connection with a Vision Sensor	3-4
3-3-1	Establishing an Online Connection from the Sensor Connection Screen	3-4
3-3-2	Establishing an Online Connection from the Multiview Explorer	3-5
3-4	Synchronizing Project Data and Sensor Setting Data.....	3-7
3-4-1	Transferring Project Data to the Sensor.....	3-7
3-4-2	Transferring Setting data in the Sensor to a Project	3-9
3-5	Ending a Connection with a Vision Sensor.....	3-11
3-5-1	Ending a Connection in the Sensor Connection Screen	3-11
3-5-2	Ending a Connection in the Multiview Explorer	3-11
3-6	Logging in to a Registered User's Account	3-12

Section 4 Configuring Measurement Settings

4-1	Overview of Processing Units	4-2
4-1-1	Input Image	4-2
4-1-2	Measurement	4-2
4-1-3	Compensate Image.....	4-2
4-1-4	Support Measurement.....	4-3
4-1-5	Branch.....	4-3
4-1-6	Output Result	4-3
4-1-7	Display Result	4-3
4-2	Editing a Processing Unit	4-5
4-2-1	Parameter Settings	4-5
4-2-2	Editing an Area.....	4-7
4-2-3	Color Extraction.....	4-10
4-2-4	Color.....	4-11
4-2-5	Binary	4-11

4-2-6	Detection Point/Reference Point	4-11
4-2-7	List.....	4-12
4-2-8	Image Control Area	4-12

Section 5 Designing Exchange with External Devices

5-1	Designing Exchange with External Devices.....	5-2
5-2	Setting Procedure	5-3

Section 6 Online Debugging

6-1	Performing Test Measurement	6-2
6-1-1	Measuring Camera Images.....	6-2
6-1-2	Measuring File Images in the RAMDisk or the External Memory, i.e. USB Flash Drive of the Vision Sensor	6-3
6-1-3	Measuring Logging Images in the Vision Sensor Memory	6-3
6-2	Checking Measurement Results.....	6-4
6-2-1	Checking Detailed Results	6-4
6-2-2	Changing the Image Display Settings	6-5
6-2-3	Checking Multiple Measurement Images at the Same Time.....	6-6
6-3	Checking Result Output	6-7
6-4	Saving Measurement Results	6-8
6-5	Saving Settings Data	6-9
6-6	Loading Settings Data	6-10

Section 7 Offline Debugging

7-1	Performing Offline Simulation of Sensor Measurement Operation	7-2
7-2	Offline Debugging of the Sensor Control Program and Sensor Operation (Only When Using EtherCAT Connection).....	7-3
7-2-1	Control Signals Supported with Offline Debugging	7-3
7-2-2	Offline Debugging Procedure for the Sensor Control Program	7-4

Section 8 Other Useful Functions

8-1	Using the Command Customize Setting Tool	8-3
8-2	Using the Calibration Support Tool.....	8-4
8-3	Using the File Save Tool.....	8-5
8-3-1	Opening the File Save Tool	8-5
8-3-2	Copying a File	8-5
8-3-3	Saving a Logging Image as a File	8-6
8-4	Using the User Data Setting Tool	8-7
8-5	Changing the System Environment	8-8
8-6	Help	8-10
8-7	Using the Security Setting Tool.....	8-11
8-8	Using the Scene Group Saving Destination Setting Tool	8-12
8-9	Using the Image File Save Tool	8-13
8-9-1	Opening the Image File Save Tool	8-13
8-9-2	Saving the Image File	8-13

8-9-3	Saving the Logged Images to Files	8-14
8-10	Using the Registered image Manager	8-16
8-11	Using the Update Standard Position Tool	8-17
8-12	Using the Conversion Scene Group Data Tool	8-18
8-13	Using the Scene Control Macro Tool	8-19
8-14	Print the Settings	8-20
8-15	Using the Variable Assignment List.....	8-21
8-15-1	Opening the Variable Assignment List	8-21
8-15-2	Check the Variable Assignment List.....	8-21
8-16	Using the Quick Access Setting Tool	8-22
8-16-1	Opening the Quick Access Setting Tool	8-22
8-16-2	Set the Quick Access	8-22
8-16-3	Set the Quick Access file save settings in Sysmac Studio.....	8-22
8-17	Using the Conveyor Panorama Display Tool	8-23
8-18	Using the Conveyor Calibration Wizard Tool	8-24
8-19	Using the Calibration Plate Print Tool.....	8-25
8-20	Using the Error Log Management Tool.....	8-26

Section 9 Limitations

9-1	Limitations	9-2
9-2	Synchronization with the NJ/NX/NY-series Controllers	9-8

Section 10 Troubleshooting

10-1	Troubleshooting for EtherCAT.....	10-2
10-2	Sysmac Error Status.....	10-3

Appendices

A-1	Sysmac Device Features.....	A-2
A-1-1	Sysmac Error Status	A-2
A-1-2	Saving the Node Address Setting	A-2
A-1-3	Serial Number Display	A-3
A-1-4	Compliance with ESI Specification (ETG.2000 S (R) V1.0.1)	A-3
A-1-5	SII Data Check	A-3
A-1-6	Support for the Cable Redundancy	A-4

Index

Terms and Conditions Agreement

Warranty, Limitations of Liability

Warranties

● Exclusive Warranty

Omron's exclusive warranty is that the Products will be free from defects in materials and workmanship for a period of twelve months from the date of sale by Omron (or such other period expressed in writing by Omron). Omron disclaims all other warranties, express or implied.

● Limitations

OMRON MAKES NO WARRANTY OR REPRESENTATION, EXPRESS OR IMPLIED, ABOUT NON-INFRINGEMENT, MERCHANTABILITY OR FITNESS FOR A PARTICULAR PURPOSE OF THE PRODUCTS. BUYER ACKNOWLEDGES THAT IT ALONE HAS DETERMINED THAT THE PRODUCTS WILL SUITABLY MEET THE REQUIREMENTS OF THEIR INTENDED USE.

Omron further disclaims all warranties and responsibility of any type for claims or expenses based on infringement by the Products or otherwise of any intellectual property right.

● Buyer Remedy

Omron's sole obligation hereunder shall be, at Omron's election, to (i) replace (in the form originally shipped with Buyer responsible for labor charges for removal or replacement thereof) the non-complying Product, (ii) repair the non-complying Product, or (iii) repay or credit Buyer an amount equal to the purchase price of the non-complying Product; provided that in no event shall Omron be responsible for warranty, repair, indemnity or any other claims or expenses regarding the Products unless Omron's analysis confirms that the Products were properly handled, stored, installed and maintained and not subject to contamination, abuse, misuse or inappropriate modification. Return of any Products by Buyer must be approved in writing by Omron before shipment. Omron Companies shall not be liable for the suitability or unsuitability or the results from the use of Products in combination with any electrical or electronic components, circuits, system assemblies or any other materials or substances or environments. Any advice, recommendations or information given orally or in writing, are not to be construed as an amendment or addition to the above warranty.

See <http://www.omron.com/global/> or contact your Omron representative for published information.

Limitation on Liability; Etc

OMRON COMPANIES SHALL NOT BE LIABLE FOR SPECIAL, INDIRECT, INCIDENTAL, OR CONSEQUENTIAL DAMAGES, LOSS OF PROFITS OR PRODUCTION OR COMMERCIAL LOSS IN ANY

WAY CONNECTED WITH THE PRODUCTS, WHETHER SUCH CLAIM IS BASED IN CONTRACT, WARRANTY, NEGLIGENCE OR STRICT LIABILITY.

Further, in no event shall liability of Omron Companies exceed the individual price of the Product on which liability is asserted.

Application Considerations

Suitability of Use

Omron Companies shall not be responsible for conformity with any standards, codes or regulations which apply to the combination of the Product in the Buyer's application or use of the Product. At Buyer's request, Omron will provide applicable third party certification documents identifying ratings and limitations of use which apply to the Product. This information by itself is not sufficient for a complete determination of the suitability of the Product in combination with the end product, machine, system, or other application or use. Buyer shall be solely responsible for determining appropriateness of the particular Product with respect to Buyer's application, product or system. Buyer shall take application responsibility in all cases.

NEVER USE THE PRODUCT FOR AN APPLICATION INVOLVING SERIOUS RISK TO LIFE OR PROPERTY OR IN LARGE QUANTITIES WITHOUT ENSURING THAT THE SYSTEM AS A WHOLE HAS BEEN DESIGNED TO ADDRESS THE RISKS, AND THAT THE OMRON PRODUCT(S) IS PROPERLY RATED AND INSTALLED FOR THE INTENDED USE WITHIN THE OVERALL EQUIPMENT OR SYSTEM.

Programmable Products

Omron Companies shall not be responsible for the user's programming of a programmable Product, or any consequence thereof.

Disclaimers

Performance Data

Data presented in Omron Company websites, catalogs and other materials is provided as a guide for the user in determining suitability and does not constitute a warranty. It may represent the result of Omron's test conditions, and the user must correlate it to actual application requirements. Actual performance is subject to the Omron's Warranty and Limitations of Liability.

Change in Specifications

Product specifications and accessories may be changed at any time based on improvements and other reasons. It is our practice to change part numbers when published ratings or features are changed, or when significant construction changes are made. However, some specifications of the Product may

be changed without any notice. When in doubt, special part numbers may be assigned to fix or establish key specifications for your application. Please consult with your Omron's representative at any time to confirm actual specifications of purchased Product.

Errors and Omissions

Information presented by Omron Companies has been checked and is believed to be accurate; however, no responsibility is assumed for clerical, typographical or proofreading errors or omissions.

Safety Precautions

For details of Safety Precautions, refer to *Safety Precautions* in the *Vision System FH/FHV Series User's Manual (Cat. No. Z365)* and the *Sysmac Studio Version 1 Operation Manual (Cat. No. W504)*.

Precautions for Safe Use

For details of Precautions for Safe Use, refer to *Precautions for Safe Use* in the *Vision System FH/FHV Series User's Manual (Cat. No. Z365)* and the *Sysmac Studio Version 1 Operation Manual (Cat. No. W504)*.

Precautions for Correct Use

For details of Precautions for Correct Use, refer to *Precautions for Correct Use* in the *Vision System FH/FHV Series User's Manual (Cat. No. Z365)* and the *Sysmac Studio Version 1 Operation Manual (Cat. No. W504)*.

Regulations and Standards

For details of Regulations and Standards, refer to *Regulations and Standards* in the *Vision System FH/FHV Series User's Manual (Cat. No. Z365)* and the *Sysmac Studio Version 1 Operation Manual (Cat. No. W504)*.

Related Manuals

The followings are the manuals related to this manual. Use these manuals for reference.

Name of Manual	Cat. No.	Model	Purpose	Contents
Vision System FH Instruction Sheet	3615791-1	FH-2□□□ FH-2□□□-□□ FH-5□□□ FH-5□□□-□□	To confirm the safety and usage precautions of the Vision System FH series Sensor Controller.	Describes the definitions of basic terms, meaning of signal words, and precautions for correct use of FH series in the manual.
Vision System FH-L Instruction Sheet	3615792-0	FH-L□□□ FH-L□□□-□□	To confirm the safety and usage precautions of the Vision System FH-Lite series Sensor Controller.	Describes the definitions of basic terms, meaning of signal words, and precautions for correct use of FH-L series in the manual.
Smart Camera FHV Instruction Sheet	3615629-0	FHV7□-□□□□□-□□□-□ □	To confirm the safety and usage precautions of the Smart Camera FHV series.	Describes the definitions of basic terms, the meaning of signal words, and precautions for correct use of FHV series in the manual.
Smart Camera Lighting Module FHV-LTM Instruction Sheet	3129276-4	FHV-LTM□□	To confirm the safety and usage precautions of the Smart camera lighting module FHV-LTM.	Describes the definitions of basic terms, the meaning of signal words, and precautions for correct use of the lighting module FHV-LTM in the manual.
Smart Camera Lens Module FHV-LEM-S Instruction Sheet	3128622-5	FHV-LEM-S□□	To confirm the safety and usage precautions of the Smart camera lens module FHV-LEM-S.	Describes the definitions of basic terms, the meaning of signal words, and precautions for correct use of the lens module FHV-LEM-S.
Smart Camera High-Speed Lens Module FHV-LEM-H Instruction Sheet	3129408-2	FHV-LEM-H□□	To confirm the safety and usage precautions of the Smart camera high-speed lens module FHV-LEM-H.	Describes the definitions of basic terms, the meaning of signal words, and precautions for correct use of the high-speed lens module FHV-LEM-H.
Smart Camera Data Unit FHV Instruction Sheet	3130057-0	FHV-SDU□□	To confirm the safety and usage precautions of the Smart Camera Data Unit.	Describes the definitions of basic terms, the meaning of signal words, and precautions for correct use of the Smart Camera Data Unit in the manual.
FHV Series Smart Camera Setup Manual	Z408	FHV7□-□□□□□-C FHV7□-□□□□□-S□□ FHV7□-□□□□□-S□□-□ □ FHV7□-□□□□□-H□□ FHV7□-□□□□□-H□□-□ □	When User want to know about the hardware specifications or to setup the Smart camera FHV series.	Describes FHV series specifications, dimensions, part names, I/O information, installation information, and wiring information.

Name of Manual	Cat. No..	Model	Purpose	Contents
Vision System FH/FHV Series User's Manual	Z365	FH-2□□□ FH-2□□□-□□ FH-5□□□	When User want to know about the FH/FHV series.	Describes the soft functions, setup, and operations to use FH/FHV series/
Vision System FH/FHV series Processing Item Function Reference Manual	Z341	FH-5□□□-□□ FH-L□□□ FH-L□□□-□□ FHV7□-□□□□□-C FHV7□-□□□□□-S□□ FHV7□-□□□□□-S□□-□	When User confirm the details of each processing items at the create the measurement flow or operate it.	Describes the software functions, settings, and operations for using FH/FHV series.
Vision System FH/FHV Series User's manual for Commu- nications Settings	Z342	□ FHV7□-□□□□□-H□□ FHV7□-□□□□□-H□□-□ □	When User confirm the setting of communication functions.	Describes the functions, settings, and communications methods for communication between FH/FHV series and PLCs. The following communications protocol are described. Parallel, PLC Link, EtherNet/IP, EtherCAT, and Non-procedure.
Vision System FH series Hardware Setup Manual	Z366	FH-2□□□ FH-2□□□-□□ FH-5□□□ FH-5□□□-□□ FH-L□□□ FH-L□□□-□□	When User want to know about the Hard-ware specifications or to setup the Sensor Controller of the Vision System FH series.	Describes FH series specifications, dimensions, part names, I/O information, installation information, and wiring information.
Vision System FH series Macro Customize Func- tions Programming Manual	Z367		When User operate or programming using Macro Customize functions.	Describes the functions, settings, and operations for using Macro Customize function of the FH series.
Vision System FH/FHV Series Operation Manual for Sysmac Studio	Z343	FH-2□□□ FH-2□□□-□□ FH-5□□□ FH-5□□□-□□ FHV7□-□□□□□-C FHV7□-□□□□□-S□□ FHV7□-□□□□□-S□□-□ □ FHV7□-□□□□□-H□□ FHV7□-□□□□□-H□□-□ □	When User connect to NJ series via EtherCAT communication.	Describes the operating procedures for setting up and operating FH/FHV series Vision Sensors from the Sysmac Studio FH/FHV Tools.

Terminology

- For descriptions of the Controller terms that are used in this manual, refer to information on terminology in the *Sysmac Studio Version 1 Operation Manual (Cat. No. W504)*.
- For descriptions of the FH/FHV Series terms that are used in this manual, refer to information on terminology in the *FH/FHV Series Vision System User's Manual (Cat. No. Z365)*.

Revision History

A manual revision code appears as a suffix to the catalog number on the front and back covers of the manual.

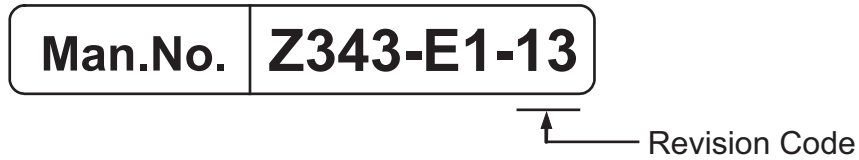

Rev. Code	Rev. Date	Revision Contents
01	Jun. 2013	First edition.
02	Sep 2013	Added offline debugging function, Support for software version 5.1 of the FH sensor controller.
03	Jan. 2014	Added additional supported processing units, added support for multiple FH unit settings, added a security function, expanded data transfer functions.
04	Jul. 2014	Additions for software version upgrade. Support for software version 5.20 of the FH sensor controller.
05	Oct. 2015	Additions for software version upgrade and FH Sensor Controller ver.5.50.
06	Apr. 2016	Corrections sentences related other manuals.
07	Apr. 2017	Additions for software version upgrade and FH Sensor Controller ver.5.71.
08	Jun. 2017	Additions for software version upgrade and FH Sensor Controller ver.5.72.
09	Jul. 2018	Additions for software version upgrade and FH Sensor Controller ver.6.10.
10	Oct. 2019	Additions for software version upgrade, FHV Smart Camera ver.6.30 and FH Sensor Controller ver.6.20, 6.30.
11	Oct. 2020	Additions for software version upgrade, FH Sensor Controller ver.6.40.
12	Sep. 2022	Revisions for adding safety precautions regarding security. Deleted the product information of FH-1000/FH-3000 series.
13	Dec. 2022	Additions for software version upgrade, FH Sensor Controller ver.6.51. Revisions for update <i>Related Manuals</i> . Added <i>A-1-6 Support for the Cable Redundancy</i> . Corrected mistakes.

1

Overview

This Chapter describes the functional specifications of the Sysmac Studio FH/FHV tools (hereinafter referred to as "FH/FHV tools").

1-1	Supported Models	1-2
1-2	Project Management	1-3
1-2-1	Project data	1-3
1-2-2	Project Data Handling in Different System Configurations	1-4

1-1 Supported Models

The FH/FHV tools support the following models in the FH/FHV Vision Sensor series.

Connection Device Type	Description
FH-555□	High-speed, Large-capacity controller for 2-channel camera type
FH-555□-10	High-speed, Large-capacity controller for 4-channel camera type
FH-555□-20	High-speed, Large-capacity controller for 8-channel camera type
FH-505□	High-speed controller for 2-channel camera type
FH-505□-10	High-speed controller for 4-channel camera type
FH-505□-20	High-speed controller for 8-channel camera type
FH-205□	Standard controller for 2-channel camera type
FH-205□-10	Standard controller for 4-channel camera type
FH-205□-20	Standard controller for 8-channel camera type
FHV7□-□□□□□-C FHV7□-□□□□□-S□□ FHV7□-□□□□□-S□□-□□ FHV7□-□□□□□-H□□ FHV7□-□□□□□-H□□-□□	Smart Camera

1-2 Project Management

Sysmac Studio manages the configuration information of each of the controller, servo, and vision sensor devices on a project basis.

Here, we describe the contents of the project data related to the FH/FHV Series and how the data is managed.

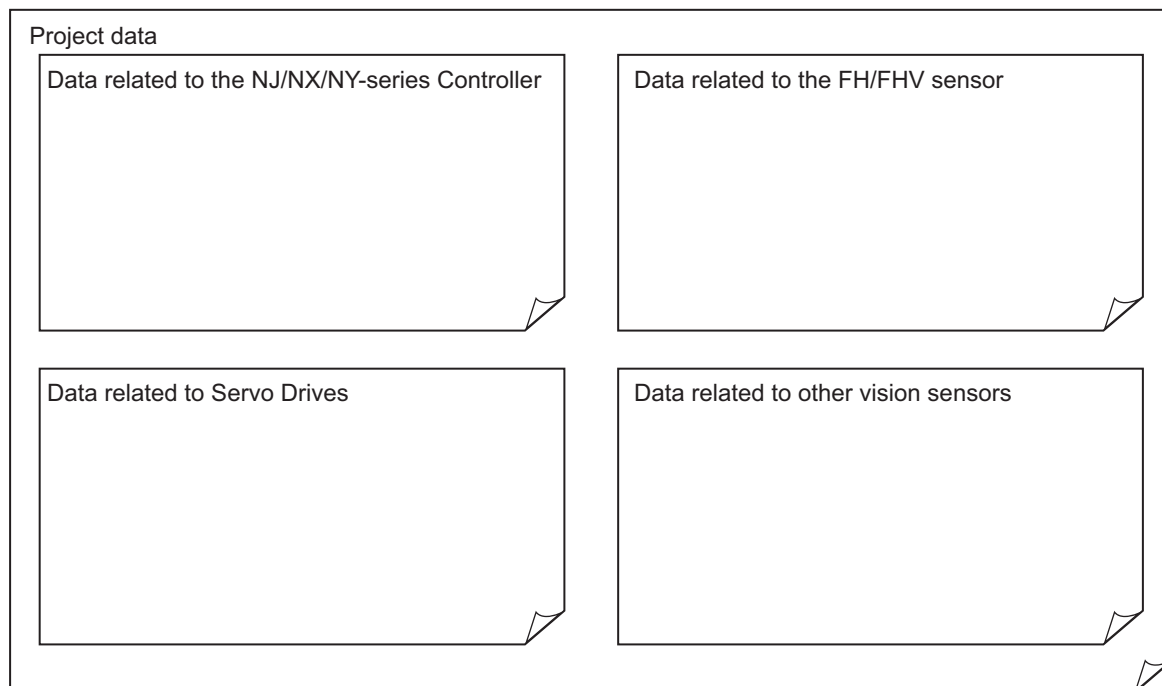

1-2-1 Project data

Eight FH/FHV vision sensor series devices can be registered to one project.

In the FH/FHV Series, the following types of data provided by Sysmac Studio are managed as project data.

- Scene group data (scene data)
- System data
- Tool data (communications command macros, security settings, and other data)

By using the Multi-line Random-trigger Mode, the FH sensor controller independently processes multiple processing lines at the same time. In Multi-line Random Trigger mode, the above data is controlled separately for each line. (It can not be used with the FHV series.)

Project data manages this data together as one batch. These data can also be exported and imported individually as file data.

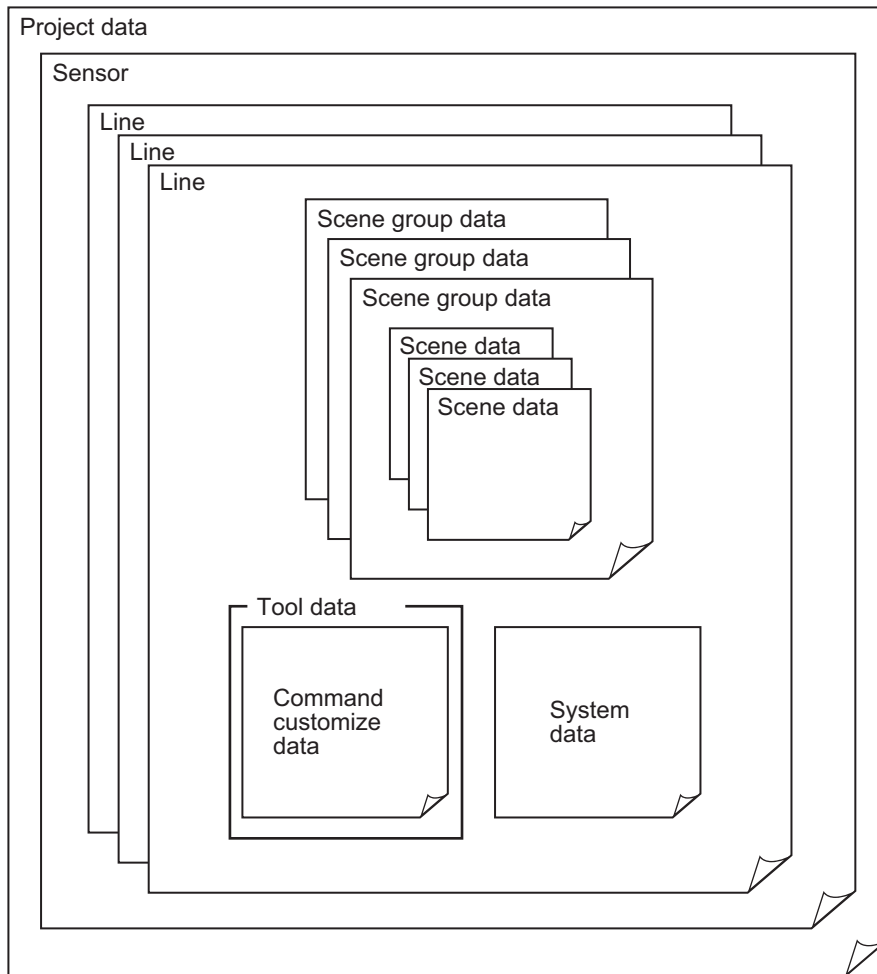

1-2-2 Project Data Handling in Different System Configurations

The contents of the Sysmac Studio project data and the data being synchronized varies depending on the connection method (i.e., Ethernet direct connection or connection through an NJ/NX/NY-series Controller) between the FH/FHV sensor and the computer that runs Sysmac Studio. Particularly with the connection through an NJ/NX/NY-series Controller, there are restrictions on some Sysmac Studio functions. Be sure you understand the following before operation.

For details, refer to the *2-8 Precautions on Synchronization through an NJ/NX/NY-series Controller* on page 2-45.

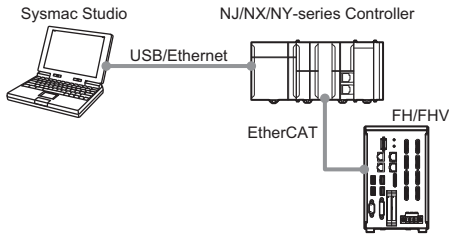
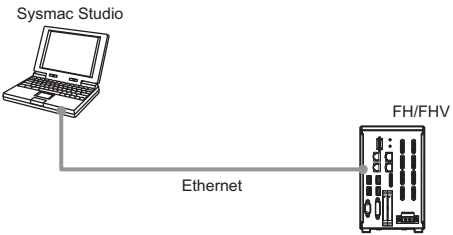
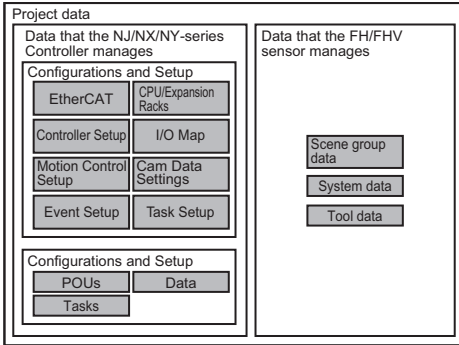
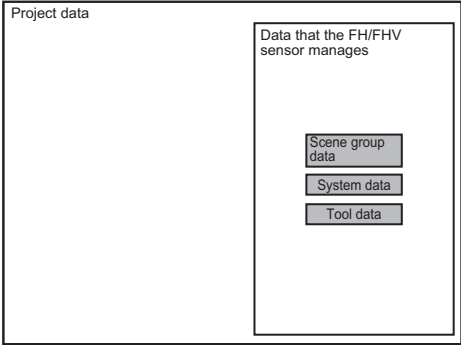
	Connection through an NJ/NX/NY-series Controller (when executing an NJ/NX/NY project)	Ethernet direct connection (when executing an FH/FHV project)
System configuration	 <p>The sensor data unit (FHV-SDU30) is required for EtherCAT connection between NJ/NX/NY-series Controller and FHV sensor. For details, refer to <i>FHV Series Smart Camera Setup Manual (Cat. No. Z408)</i>.</p>	
Project data that the Sysmac Studio manages	<p>There are two types of data: the data that the NJ/NX/NY-series Controller manages and the data that the FH/FHV sensor manages.</p> 	<p>There is the data that the FH/FHV sensor manages.</p> 
Data to be synchronized with Sysmac Studio	<p>The data that the NJ/NX/NY-series Controller manages within the project data that Sysmac Studio manages is synchronized. Because the data that the FH/FHV sensor manages (i.e., the settings data for the FH/FHV sensor) is not synchronized, the settings for the FH/FHV sensor need to be synchronized separately. For details, refer to the <i>2-8 Precautions on Synchronization through an NJ/NX/NY-series Controller</i> on page 2-45.</p>	<p>The data that the FH/FHV sensor manages (i.e., the settings data for the FH/FHV sensor) within the project data that Sysmac Studio manages is synchronized. For details, refer to the <i>3-4 Synchronizing Project Data and Sensor Setting Data</i> on page 3-7.</p>
Available functions in Sysmac Studio that control the FH/FHV sensor Online	<p>Checking the data output from the FH/FHV sensor sent through EtherCAT is possible. Making setting changes, and creating and adjusting the measurement flows for the FH/FHV are not possible.</p>	<p>Making setting changes on the FH/FHV sensor, creating and adjusting the measurement flows for the FH/FHV in addition to checking the output data from the FH/FHV sensor are all possible.</p>
Available functions in Sysmac Studio that control the FH/FHV sensor Offline	<p>Checking the data output from the FH/FHV sensor sent through EtherCAT is possible. Making setting changes on the FH/FHV sensor, creating and adjusting the measurement flows for the FH/FHV in addition to checking the output data from the FH/FHV sensor are all possible.</p>	<p>Making setting changes on the FH/FHV sensor, creating and adjusting the measurement flows for the FH/FHV in addition to checking the output data from the FH/FHV sensor are all possible.</p>

	Connection through an NJ/NX/NY-series Controller (when executing an NJ/NX/NY project)	Ethernet direct connection (when executing an FH/FHV project)
Downloading the settings data for the FH/FHV sensor	<p>The settings data for the FH/FHV sensor is not downloaded.</p> <p>Performing the data downloading from Sysmac Studio will not download the data that the FH/FHV sensor manages within the project data that Sysmac Studio manages. Therefore, the settings for the FH/FHV sensor will not be overwritten. There are following two methods to download the FH/FHV settings data to the FH/FHV sensor.</p> <ul style="list-style-type: none"> • Directly connecting to the FH/FHV sensor and downloading the data. • Extracting the data from Sysmac Studio and loading it to the FH/FHV sensor via the external memory. 	<p>Downloading the FH/FHV settings data from Sysmac Studio is possible.</p> <p>If the FH/FHV sensor is connected to the computer that runs Sysmac Studio via Ethernet, downloading the FH/FHV settings data from Sysmac Studio to the FH/FHV sensor is possible by transferring the project data that the Sysmac Studio manages to the FH/FHV sensor via the Ethernet.</p> <p>If not connected, right-click the FH/FHV sensor in the Multiview Explorer and select Save file from the menu to save the data in the external memory. Then, load the data in the external memory to the FH/FHV sensor.</p>
Uploading the settings data for the FH/FHV sensor	<p>The settings data for the FH/FHV sensor is not uploaded.</p> <p>After performing the data uploading to Sysmac Studio, all the FH/FHV settings data values (i.e., the scene group data, the system data, the communications command macros, and the security settings data) that the FH/FHV sensor manages within the project data that Sysmac Studio manages will be reset to the factory defaults. The device variables related to the FH/FHV sensor in the I/O Map are uploaded. There are following two methods to transfer the settings data for the FH/FHV sensor to Sysmac Studio.</p> <ul style="list-style-type: none"> • Directly connecting to the FH/FHV sensor and uploading the data. • Save the settings data in the FH/FHV sensor in the external memory and load it to Sysmac Studio via the external memory. 	<p>Uploading the settings data for the FH/FHV sensor to Sysmac Studio is possible.</p> <p>If the FH/FHV sensor is connected to the computer that runs Sysmac Studio via Ethernet, loading the data in the FH/FHV sensor to Sysmac Studio project is possible by transferring the FH/FHV settings data to the project via Ethernet.</p> <p>If not connected, connect the external memory that holds the FH/FHV settings data to the computer that runs Sysmac Studio. Then, right-click the FH/FHV sensor in the Multiview Explorer and select Load from file from the menu to load the data.</p>



Precautions for Correct Use

The data that the NJ/NX/NY-series Controller manages and the data that the FH/FHV sensor manages are handled separately on Sysmac Studio except for the I/O Map data that the NJ/NX/NY-series Controller manages. The I/O Map is associated to the system data that the FH/FHV sensor manages. Because of this, the information in the I/O Map will be updated and changed after editing the data that the FH/FHV sensor controller manages (i.e., the settings data for the FH/FHV sensor).

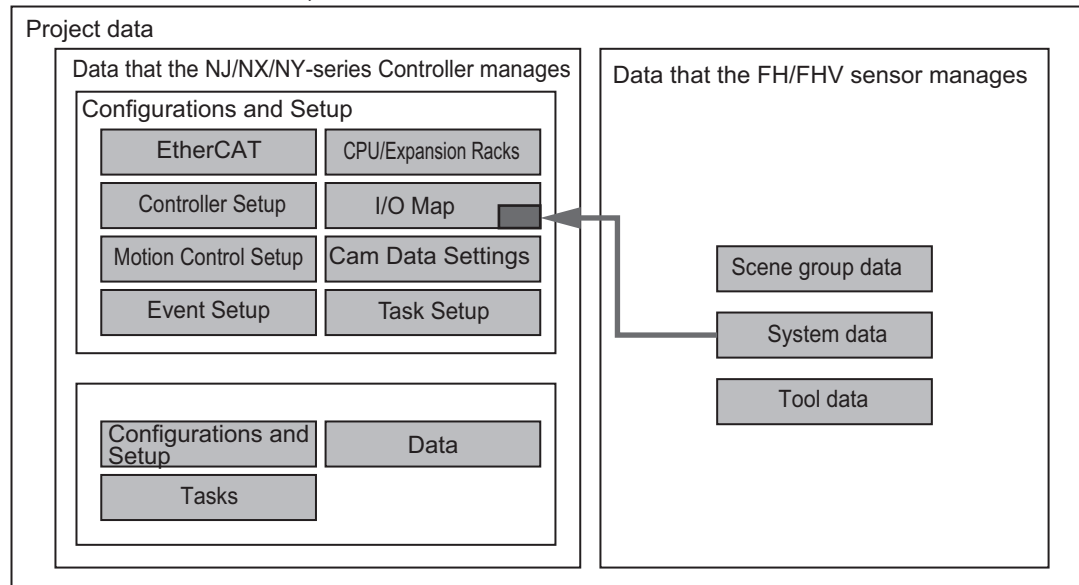

2

Basic Operations

This chapter describes the basic design flow and design items for using Sysmac Studio.

Note:

- The contents of the Sysmac Studio project data and the data being synchronized varies depending on the connection method (i.e., Ethernet direct connection or connection through an NJ/NX/NY-series Controller) between the FH/FHV sensor and the computer that runs Sysmac Studio.
- For information on connection through an NJ/NX/NY-series Controller, refer to *2-8 Precautions on Synchronization through an NJ/NX/NY-series Controller* on page 2-45.

2-1	Basic Design Flow 1	2-3
2-2	Basic Design Flow 2	2-5
2-3	Creating a New Project	2-7
2-3-1	Creating a New Project File from the Project Window	2-7
2-3-2	Adding FH/FHV Device to a Project	2-8
2-3-3	Deleting FH/FHV Device from a Project	2-9
2-4	Description of Screen Components	2-10
2-4-1	Application Window	2-10
2-4-2	Menu Bar	2-10
2-4-3	Toolbar	2-11
2-4-4	Multiview Explorer	2-11
2-4-5	Edit Pane	2-13
2-4-6	Toolbox	2-30
2-5	Basic Operations of Scene Data	2-32
2-5-1	Switching Scenes	2-32
2-5-2	Managing Scenes	2-33
2-5-3	Entering Scene Information	2-33
2-5-4	Searching for a Scene	2-34
2-5-5	Switching Scene Groups	2-34
2-5-6	Managing Scene Groups	2-34
2-5-7	Entering Scene Group Information	2-35
2-6	Basic Operations of Flow Editing	2-36
2-6-1	Adding a Processing Unit	2-36
2-6-2	Managing Processing Units	2-37
2-6-3	Searching for a Processing Unit	2-39

2-7	Function List.....	2-40
2-7-1	List of Functions Provided with the FH/FHV Tool	2-40
2-7-2	Comparison with FH Series Unit Functions	2-42
2-7-3	Comparison with FHV Series Unit Functions.....	2-43
2-8	Precautions on Synchronization through an NJ/NX/NY-series Controller	2-45
2-8-1	Synchronized Project Data	2-45
2-8-2	Saving and Loading the Settings Data for the FH/FHV Sensor Controller ...	2-46
2-8-3	Transferring Data from the Sysmac Studio	2-47
2-8-4	Transferring Data to the Sysmac Studio	2-48

2-1 Basic Design Flow 1

This section describes the flow for designing a system that uses NJ/NX/NY-series CPU Unit as a controller.

For details on the program on the NJ/NX/NY-series CPU Unit side, task design, and debugging, refer to the *Sysmac Studio Version 1 Operation Manual (Cat. No. W504)*.



Precautions for Correct Use

The settings data for the FH/FHV sensor cannot be synchronized with the data in the Sysmac Studio project via an NJ/NX/NY-series Controller.

For details, refer to *2-8 Precautions on Synchronization through an NJ/NX/NY-series Controller* on page 2-45.

To synchronize them, directly connect the FH/FHV sensor to the computer that runs Sysmac Studio via Ethernet.

For details, refer to *3-4 Synchronizing Project Data and Sensor Setting Data* on page 3-7.

New project settings

Create a project file.

1. Starting Sysmac Studio

Start Sysmac Studio.

For details, refer to *Starting and Exiting the Sysmac Studio* in the *Sysmac Studio Version 1 Operation Manual (Cat. No. W504)*.

2. Designing a new project

Create a new project.

For details, refer to *Creating a Project File* in the *Sysmac Studio Version 1 Operation Manual (Cat. No. W504)*.

Controller configuration and settings

• Controller configuration:

1. Creating an EtherCAT configuration

Register FH/FHV as an EtherCAT slave in **EtherCAT**.

For details, refer to *EtherCAT Configuration and Settings* in the *Sysmac Studio Version 1 Operation Manual (Cat. No. W504)*.

2. Registering device variables

When using or using after editing device variables for the user defined variables to connect the FH/FHV I/O information and program, register the device variables in **I/O Map**.

For details, refer to *Creating Device Variables* in the *Sysmac Studio Version 1 Operation Manual (Cat. No. W504)*.

• Controller settings:

1. Editing slave parameters

Edit the **Operation Settings** of the slaves.

For details, refer to *Creating the EtherCAT Slave Terminal Configuration* in the *Sysmac Studio Version 1 Operation Manual (Cat. No. W504)*.

Sensor connection

Establish an online connection with the sensor.

1. Connecting a sensor

For details, refer to *Section 3 Connecting with a Vision Sensor* on page 3-1.

Design

Create the processing flow.

1. Creating flow

For details, refer to *2-6 Basic Operations of Flow Editing* on page 2-36.

2. Editing processing units

For details, refer to *4-2 Editing a Processing Unit* on page 4-5.

Online debugging of sensor

Perform debugging using the actual device.

1. Performing test measurement

Perform test measurement on sample work. Adjust the parameters if necessary.

For details, refer to *Section 6 Online Debugging* on page 6-1.

2-2 Basic Design Flow 2

This section describes the flow for designing a system that uses a controller other than NJ/NX/NY-series CPU Unit.

New project settings

Create a project file.

1. Starting Sysmac Studio

Start Sysmac Studio.

For details, refer to *Starting and Exiting the Sysmac Studio* in the *Sysmac Studio Version 1 Operation Manual (Cat. No. W504)*.

2. Designing a new project

Create a new project.

Select a vision sensor for the **category** and FH/FHV for the **device**.

For details, refer to *2-3 Creating a New Project* on page 2-7.

3. Selecting sensor type

Select the sensor type and then establish an online connection.

For details, refer to the step 3 on *2-3-1 Creating a New Project File from the Project Window* on page 2-7.

Sensor configuration and settings

- Sensor configuration:

1. Creating an interface configuration for the sensor

Edit the interface configuration.

For details, refer to *5-2 Setting Procedure* on page 5-3.

- Sensor settings:

1. Editing the communication conditions

Edit the communication conditions of the sensor.

For details, refer to *5-2 Setting Procedure* on page 5-3.

Design

Create the processing flow.

1. Creating flow

For details, refer to *2-6 Basic Operations of Flow Editing* on page 2-36.

2. Editing processing units

For details, refer to *4-2 Editing a Processing Unit* on page 4-5.

Online debugging of sensor

Perform debugging using the actual device.

1. Performing test measurement

Perform test measurement on sample work. Adjust the parameters if necessary.

For details, refer to *Section 6 Online Debugging* on page 6-1.

2-3 Creating a New Project

This section describes how to create a new project file. For details on the basic operations, refer to *Creating a Project* in the *Sysmac Studio Version 1 Operation Manual (Cat. No. W504)*.

Here, we describe how to create a new project for the FH/FHV vision sensor (hereinafter referred to as "FH/FHV project").

2-3-1 Creating a New Project File from the Project Window

- 1 Click the **New Project** button in the project window.
- 2 In the **Project Properties** dialog box, enter the information in **Project name**, **Author** (optional), and **Comment** (optional), select the following device from **Category** and **Device** of **Select Device**, and click the **Create** button.

Item	Setting
Category	Vision sensor
Device	<ul style="list-style-type: none"> • FH • FHV

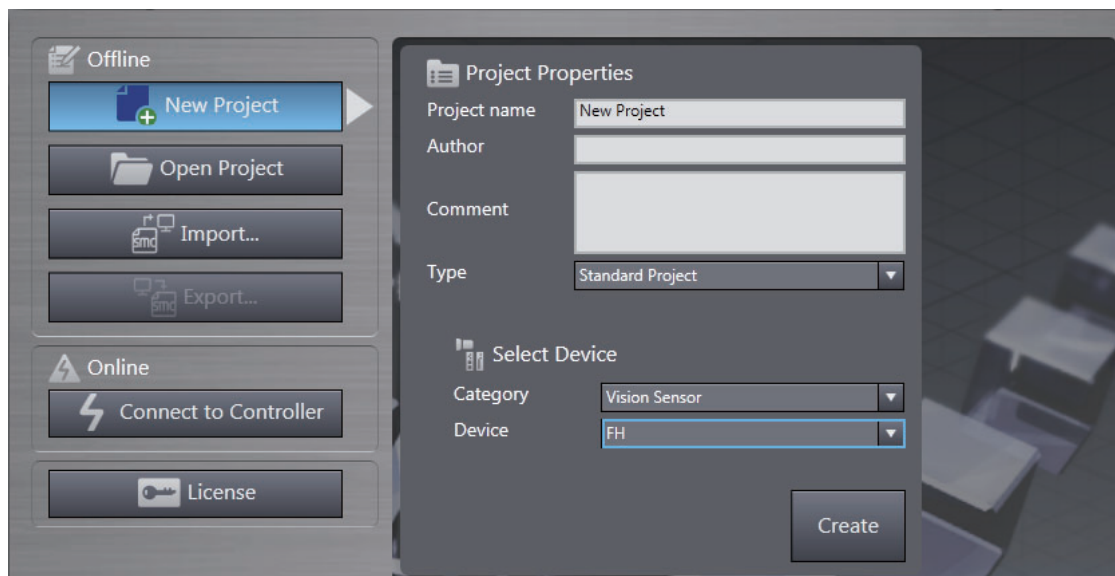

- 3 Select the FH/FHV vision sensor to connect to.
When establishing an online connection, click **Search for sensors** and then click the **Search** button. The found sensors are displayed in a list. Select the sensor you wish to connect to and then click the **OK** button.
If you know the IP address of the sensor you wish to connect to beforehand or will connect to a sensor via a router, select the **Specify the IP address** check box and then enter the IP address in **IP address**. After input is complete, click the **OK** button.
If you wish to edit the settings offline, click **Enter the type**, select the **Type** and **Version** items for the sensor you wish to edit, and then click the **OK** button.

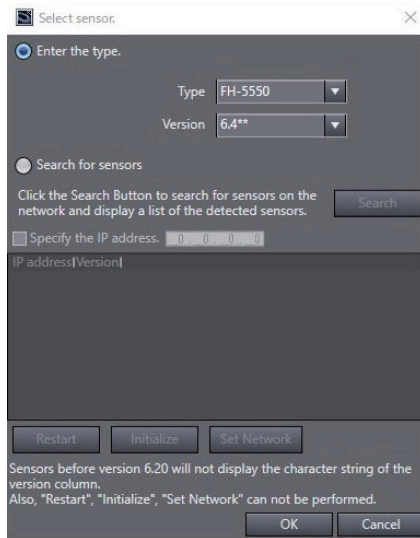

- 4 A new project is created.
The project file is created and the next screen appears.

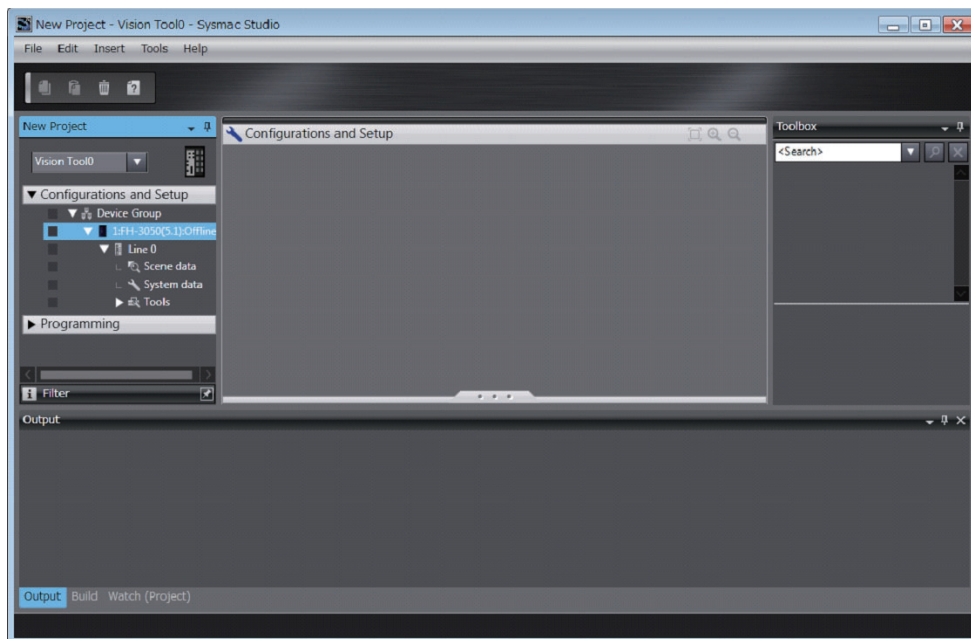

Precautions for Correct Use

- An online connection cannot be established if the FH/FHV device registered to the project and the actual device are not the same type and version.
- If there is already a different FH/FHV slave device in the project with an established online connection, you will not be able to establish an online connection for a new FH/FHV slave device. To establish an online connection for a new FH/FHV slave device, switch the other FH/FHV slave device from online to offline.

2-3-2 Adding FH/FHV Device to a Project

You can add an FH/FHV device to a project.

Right-click the Device Group and select **Add - FH** or **Add - FHV**.

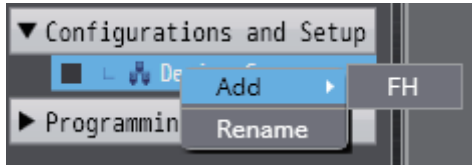

The sensor selection screen appears. Select the sensor type.
The selected FH/FHV device is registered.

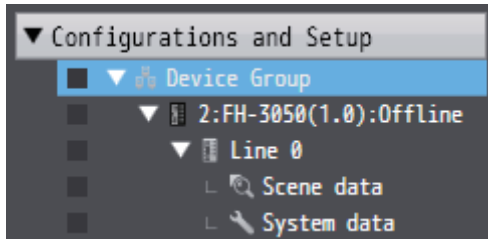

2-3-3 Deleting FH/FHV Device from a Project

You can delete FH/FHV device from a project.
Right-click the FH/FHV vision sensor you wish to delete and select **Delete**.

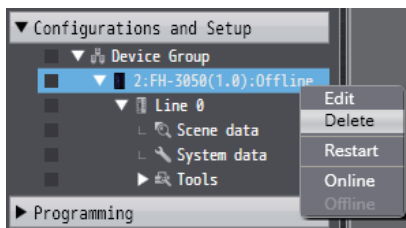

2-4 Description of Screen Components

This section describes the screen components in FH/FHV project.

For a description of the screen components in NJ/NX/NY-series CPU Unit project, refer to *Parts of the Window* in the *Sysmac Studio Version 1 Operation Manual (Cat. No. W504)*.

2-4-1 Application Window

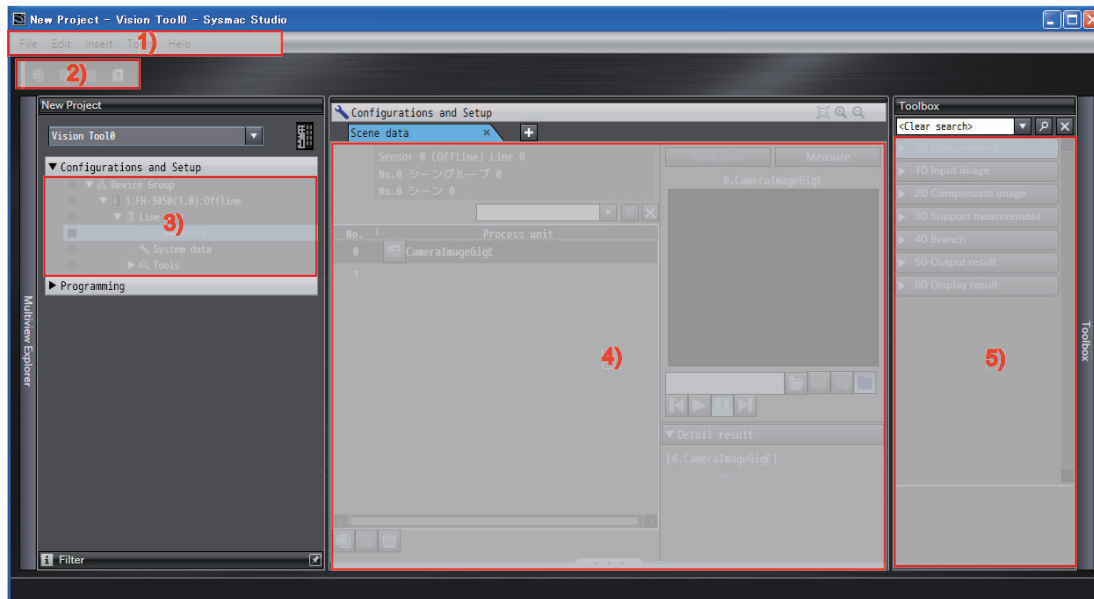

No.	Name
1	Menu Bar
2	Toolbar
3	Multiview Explorer
4	Edit Pane
5	Toolbox

2-4-2 Menu Bar

	Menu Name	Description
File	Close	Closes the project.
	Save	Saves the project.
	Save As	Saves the project with a different name.
	Save As New Number	Saves the project with a new update number.
	Import	Imports an exported file so that it can be edited in the tool.
	Export	Saves the project as an external file.
	Exit	Closes Sysmac Studio.
Edit	Copy	Copies the selected item.
	Paste	Pastes the copied item.
	Delete	Deletes the selected item.

Menu Name		Description
View	Multiview Explorer	Displays the Multiview Explorer.
	Toolbox	Displays the Toolbox.
	Reset Window Layout	Resets the window layout.
Insert	Controller	Inserts an NJ or NX project.
	Displacement Sensor	Inserts a ZW project.
	Vision Sensor	Inserts an FH or FHV project.
Tools	Options	Displays the Options menu.
Help	Help Contents	Displays <i>Vision System FH/FHV Series Operation Manual Sysmac Studio (Cat. No. Z343)</i> .
	Keyboard Mapping Reference	Displays the shortcut key reference.
	Online Registration	Performs online registration.
	About Sysmac Studio	Displays the version of Sysmac Studio.

2-4-3 Toolbar

Button Name	Description
Copy	Copies the selected item.
Paste	Pastes the copied item.
Delete	Deletes the selected item.
Help	Displays <i>Vision System FH/FHV Series Operation Manual Sysmac Studio (Cat. No. Z343)</i> .

2-4-4 Multiview Explorer

- This pane will be the access point for all data of the FH/FHV series.
- You can right-click any data item that can be set and select an item from the menu (context menu). You can also display various editing screens in the Edit Pane.
- Multiview Explorer can be displayed or hidden by clicking the display/hidden bar on the left side of the window. Even when hidden, it can be displayed temporarily by placing the mouse pointer over the display/hidden bar. Moving the mouse pointer away from the bar returns the Multiview Explorer to the hidden state.

Item list that make up the Multiview Explorer and the menu items displayed by right-clicking

Tree View Items	Menu Item	Description
Device Group	Add - FH/FHV	Adds a sensor to the project.
	Rename	Changes the device group name.

Tree View Items		Menu Item	Description
Type		Edit	Displays the main screen in the Edit Pane.
		Delete	Deletes the sensor from the project.
		Restart	Restarts the sensor.
		Online	Switches the connection state with the sensor to on-line.
		Offline	Switches the connection state with the sensor to off-line.
		Stop offline editor	Ends the offline editor. Ends the following application. • FZ-CoreRA<current_line_number_0_to_7>.exe
		Change Version	Changes the sensor version. When the version is changed, the setting data is initialized. This menu item only appears in NJ/NX/NY Project.
Line X (X=0,1,,7)		Monitor window	Displays the monitor window in the Edit Pane.
		Scene maintenance window	Displays the Scene maintenance window in the Edit Pane.
		Save data	Saves the sensor settings data to non-volatile memory.
		Copy	Copies setting data of the line.
		Paste	Pastes the copied setting data of the line.
		Rename	Changes the line name.
		Save to file	Saves scene group 0 + system data to a file.
		Load from file	Loads scene group 0 + system data from a file.
		Print	Displays the print settings parameters in the Edit Pane.
Scene data		Edit	Displays the scene data editing screen in the Edit Pane.
		Copy	Copies the scene group data.
		Paste	Pastes the scene group data.
		Delete	Deletes the scene group data.
		Save to file	Saves the scene group data to a file.
		Load from file	Loads the scene group data from a file.
System data		Edit	Displays the system data editing screen in the Edit Pane.
		Copy	Copies the system data.
		Paste	Pastes the system data.
		Delete	Deletes the system data.
		Save to file	Saves the system data to a file.
		Load from file	Loads the system data from a file.
Tools	Communication Command Macro	Edit	Displays the communication command macro tool in the Edit Pane.
		Copy	Copies the communication command macro data.
		Paste	Pastes the communication command macro data.
		Delete	Deletes the communication command macro data.
		Save to file	Saves the communication command macro data to a file.
		Load from file	Loads the communication command macro data from a file.

Tree View Items	Menu Item	Description
Calibration Support Tool	Edit	Displays the calibration support tool in the Edit Pane.
User Data	Edit	Displays the user data tool in the Edit Pane.
Save file	Edit	Displays the file saving tool in the Edit Pane.
Conveyor Panorama Display	Edit	Displays the Conveyor Panorama Display tool in the Edit Pane.
Image file save	Edit	Displays the image file save tool in the Edit Pane.
Scene Control macro tool	Edit	Displays the scene macro tool in the Edit Pane.
Conveyor Calibration Wizard	Edit	Displays the Conveyor Calibration Wizard tool in the Edit Pane.
Scene Group Saving Destination Settings	Edit	Displays the setting tool for the scene group saving destination in the Edit Pane.
Calibration Plate Print	Edit	Displays the Calibration Plate Print tool in the Edit Pane.
Security settings	Edit	Displays the security setting tool in the Edit Pane.
Registered image Manager	Edit	Displays the registered image manager in the Edit Pane.
Update standard position tool	Edit	Displays the update standard position tool in the Edit Pane.
Conversion scene group data tool Edit	Edit	Displays the conversion scene group data tool in the Edit Pane.
Variable assignment list	Edit	Displays the variable assignment list in the Edit Pane.
Quick access setting tool	Edit	Displays the quick access setting tool in the Edit Pane.



Precautions for Correct Use

The displayed line number changes according to the operation mode. In the Multi-line Random Trigger operation mode, the set number of lines are displayed. In the Non-stop Adjustment operation mode, line 0 and 1 are displayed. For details on the operation mode, refer to *Vision System FH/FHV Series User's Manual (Cat. No. Z365)*.

2-4-5 Edit Pane

This pane is for displaying and editing the detailed data of all items.
The following screens are provided.

Screen	Description	Reference Page
Sensor connection screen	This allows you to access the sensor information, the connection with the sensor, the main screen of each line, etc.	page 2-15

Screen	Description	Reference Page
Monitor window	This allows you to check the measurement results.	page 2-16
Scene maintenance window	This allows you to switch scenes or scene groups, and copy or delete a scene and a scene group. It also allows you to perform test measurement and check the measurement results.	page 2-20
Scene data editing screen	This allows you to set the scene data.	page 2-25
System data editing screen	This allows you to set the system data.	page 2-28
Communication command macro screen	This allows you to set the communication command macro.	-
User Data tool screen	This allows you to edit the user data.	-
File Save Tool screen	This allows you to copy or move files between the RAMDisk/ external memory of the FH/FHV vision sensor or between the RAMDisk/external memory and a computer. It also allows you to save the logging image stored in the vision sensor memory to the RAMDisk or external memory of the sensor, or to a computer.	page 8-5
Calibration support tool screen	This allows you to check the calibration settings.	page 8-4
Security settings	With this tool, it is possible to restrict access to FH/FHV Vision Image Sensor to specific users and user groups.	page 8-11
Scene Group Saving Destination Settings	With this tool, it is possible to set the storage location of scene group data.	page 8-12
Image file save	With this tool, it is possible to save logged images and image files that are saved in the Image Sensor to a RAM disk or external memory device in FH/FHV Vision Sensor, or to a computer.	page 8-13
Registered image Manager	With this tool, it is possible to save images used for model registration and reference registration as registration images. The saved images can be used for re-registration and adjustment of reference positions.	page 8-16
Update standard position tool	With this tool, it is possible to set or change the reference position for more than one processing unit that is specified in the measurement flow.	page 8-17
Conversion scene group data tool	With this tool, it is possible to create a scene group that has more than or equal to 129 scenes.	page 8-18
Scene Control macro tool	With this tool, it is possible to supplement and expand measurement flow and scene control.	page 8-19
Variable assignment list	Displays the assignment list of the System variables and Scene variables registered in the FH/FHV.	page 8-21
Quick access setting tool	With this tool, it is possible to set the quick access "Ident name", "Absolute path", and "Display name". By setting the quick access, you can select the quick access when specifying the path of the file or folder. By setting for each environment, various paths can be set without paying attention to the environment-dependent drive configuration.	page 8-22
Conveyor Panorama Display	This tool is used for conveyor tracking applications. This tool is used to display a panoramic composition of workpieces being carried by conveyor. To adjust the trigger interval and conveyor speed for additional lines or new product types, this tool combines images to create a panoramic image, and then displays the region of captured image and the registered region of the model of the target objects over it.	*1

Screen	Description	Reference Page
Conveyor Calibration Wizard	This tool is used for conveyor tracking applications to reciprocally convert different coordinates for image sensor, conveyor, and robots by giving instructions in a wizard-style.	*1
Calibration Plate Print	This tool is used for conveyor tracking applications to print Calibration Pattern.	*1

*1. This function is applicable to the Conveyor Tracking Calibration Application.
For details, refer to *Vision Sensor FH series Conveyor Tracking Application Programming Guide (Cat. No. Z368)*.

Sensor connection screen

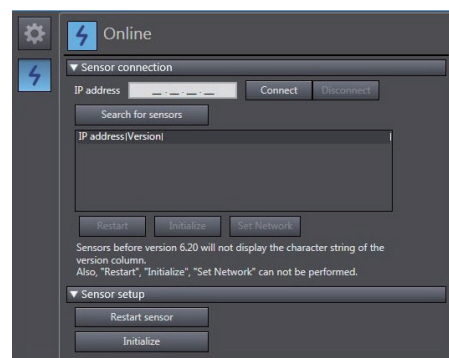
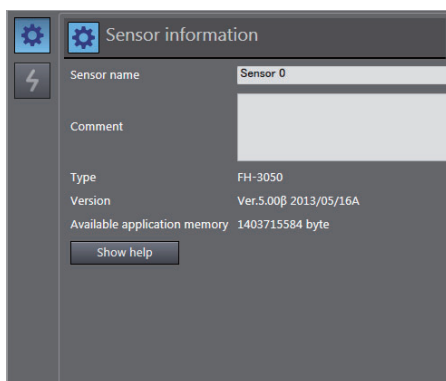

This allows you to access the sensor information, the connection with the sensor, the main screen of each line, etc.

Group	Item	Description
Sensor information	Sensor name	Allows you to change the sensor name.
	Comment	Allows you to enter a comment for the sensor.
	Type	Displays the sensor type information.
	Version	Displays the sensor version information.
	Available application memory	Displays the amount of available application memory.
Online	IP address	Sets the IP address of the sensor for online connections.
	Connect	Establishes an online connection to the sensor with the specified IP address.
	Disconnect	Disconnects the sensor currently connected with an online connection.
	Search for sensors	Searches for sensors within the same network.
	Sensor Restart	Restarts the sensor.
	Initialize	Initializes the sensor.



Additional Information

- For details on the settings in the sensor connection screen, refer to *3-3 Establishing an Online Connection with a Vision Sensor* on page 3-4.
- If there is already a different FH/FHV slave device in the project with an established online connection, you will not be able to establish an online connection for a new FH/FHV slave device. First, switch the other FH/FHV slave device from online to offline.

Monitor window

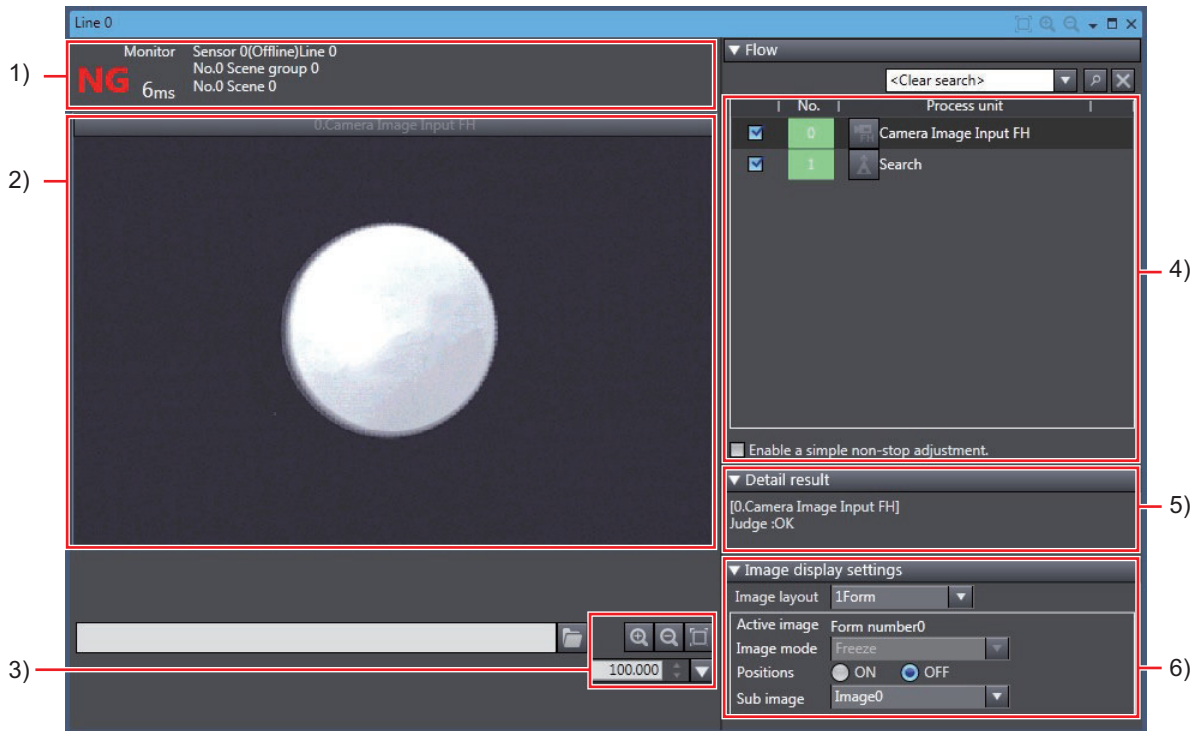

This allows you to check the measurement results.

No.	Screen Component	Description	Reference Page
1	Status display area	This allows you to access the sensor information, the connection with the sensor, the main screen of each line, etc.	page 2-16
2	Image display area	This allows you to check the measurement results.	page 2-17
3	Image size control section	Enlarges or reduces the selected image.	page 2-17
4	Flow	Displays the processing flow for the relevant line or current scene.	page 2-18
5	Detail result	Displays the results for the processing unit selected in the flow.	page 2-19
6	Image display settings	Sets the display settings for images displayed in the image display area.	page 2-19

● Status display area

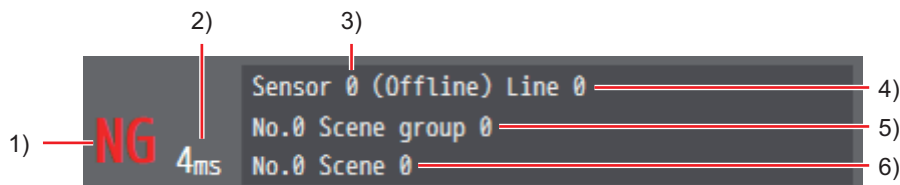

No.	Item	Description
1	Judgment result	Displays the judgment result (OK or NG).
2	Processing time	Displays the processing time for the most recent measurement process.

No.	Item	Description
3	Sensor name and IP address	Displays the sensor name and IP address. When the sensor is offline, <i>Offline</i> is displayed instead of the IP address.
4	Line name	Displays the line for which information is currently being displayed.
5	Scene group name	Displays the current scene group number and scene group name.
6	Scene name	Displays the current scene number and scene name.

● Image display area

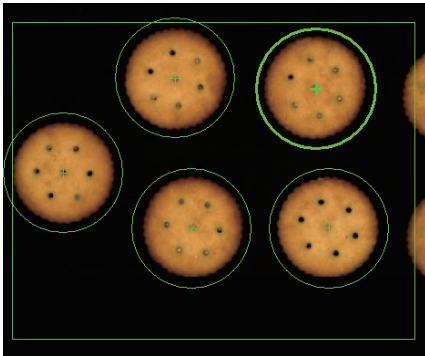

This displays the image and measurement result (graphic) for the processing unit selected in the flow display.

The settings for image display in the image display area can be changed in the **Image display settings** menu.

For details on the **Image display settings** menu, refer to *Image display settings* on page 2-19.

While an image is displayed enlarged, you can change the display area by left-clicking and dragging the displayed image.

● Image size control section

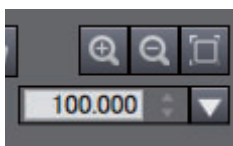

This allows you to enlarge or reduce the selected image.

Button	Description
	Enlarges the image. Image display is enlarged in 20% steps. (Upper limit: 1600%)
	Reduces the image. Image display is reduced in 20% steps. (Lower limit: 1%)
	Makes the image fit the display frame
	Enlarges or reduces the image.

● Flow

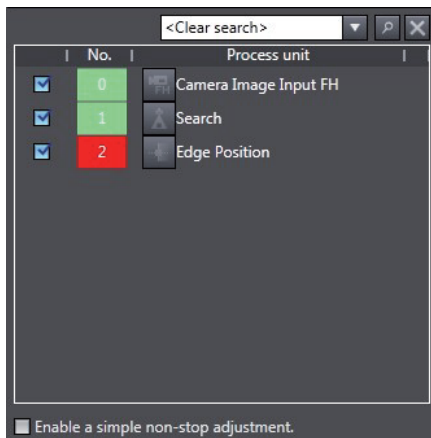

This displays the processing flow for the relevant line or current scene.

If a processing unit displayed in the list is selected, the following display information is linked and so changes accordingly.

- Image display information
- Detailed result display information

If multiple images are displayed, the display information of the image with the focus on it changes.

If a processing unit is searched in the search area, the focus moves to the found processing unit.

Item	Description
Search	Searches for the specified processing unit from within the processing flow.
Flow list	Displays the processing flow for the relevant line or current scene.

With this tool, it is possible to select a processing unit to be used for measurement. The measurements whose processing units with the checkmark removed will not be performed.

Check **Enable Simplified Non-stop Adjustment** to adjust the judgement conditions for each processing unit. The judgement condition editing pane Opens by the following methods:

- Select **Edit** from the context menu of the relevant processing unit within the measurement flow
- Click the icon of the relevant processing unit

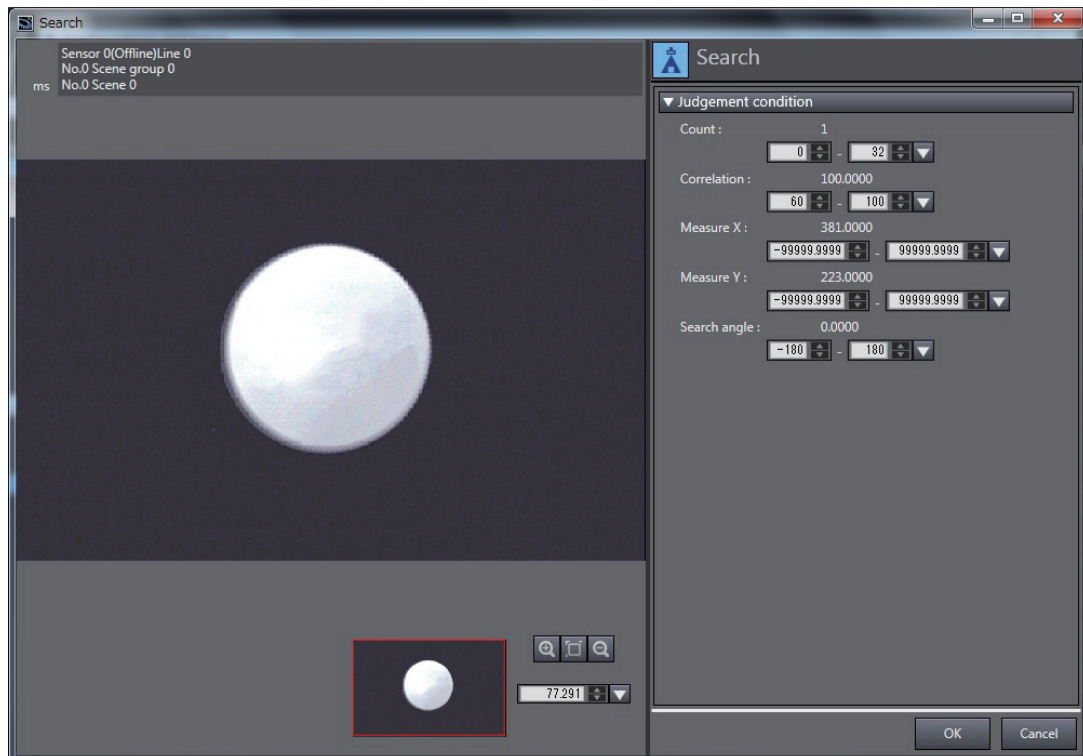

● Detail result

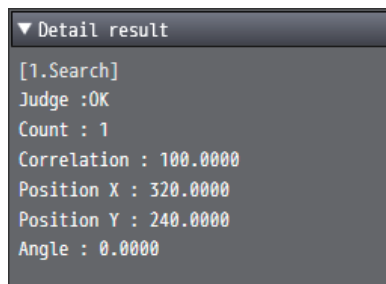

This displays the results for the processing unit selected in the flow.

● Image display settings

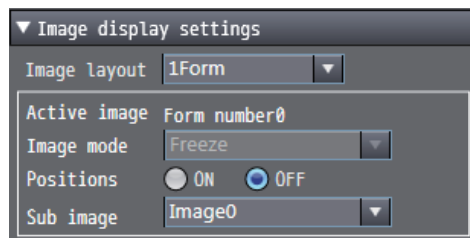

Item	Description
Image layout	Selects the number of images to display. Selection items: 1Form, 2Form, and 4Form
Image mode	Selects the image mode for the image with the focus on it. Selection items: Through, Freeze, and NG image
Positions	Selects position list display for the image with the focus on it. Selection items: OFF and ON

Item	Description
Sub image	Selects the sub image number for the image with the focus on it. Available sub-image numbers vary depending on the processing item. Select items: Image0, Image1,..., image31

This sets the displays settings for images displayed in the image display area.

Scene maintenance window

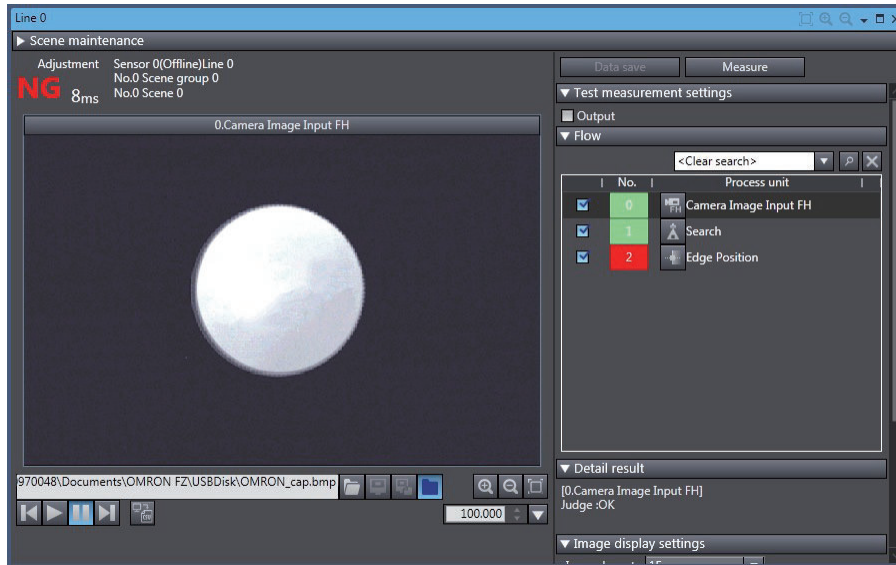

This allows you to copy, switch, and clear scene data and scene group data. It also allows you to perform test measurement and check the measurement results.

● Status display area

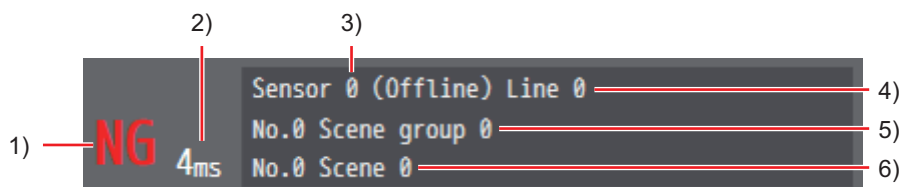

No.	Item	Description
1	Judgment result	Displays the judgment result (OK or NG).
2	Processing time	Displays the processing time for the most recent measurement process.
3	Sensor name and IP address	Displays the sensor name and IP address. When the sensor is offline, <i>Offline</i> is displayed instead of the IP address.
4	Line name	Displays the line for which information is currently being displayed.
5	Scene group name	Displays the current scene group number and scene group name.
6	Scene name	Displays the current scene number and scene name.

● Image display area

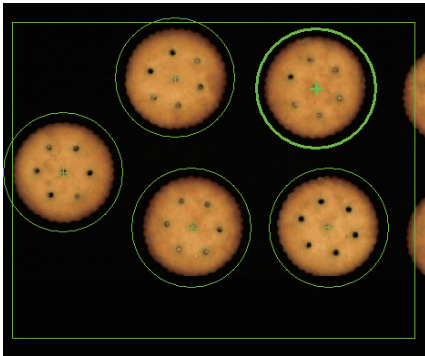





This displays the image and measurement result (graphic) for the processing unit selected in the flow display.

The settings for image display in the image display area can be changed in the **Image display settings** menu.

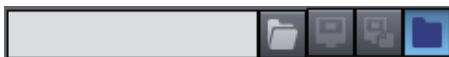
For details on the **Image display settings** menu, refer to *Image display settings* on page 2-19. While an image is displayed enlarged, you can change the display area by left-clicking and dragging the displayed image.

● File selection section







Button	Description
	Displays camera images. Selection is not possible when offline.
	Displays logging images. Selection is not possible when offline.
	Displays file images. When online, displays images in the RAMDisk or external memory, i.e. USB flash drive. When off-line, displays images in the following folder on the computer. C:\Documents and Settings\ <user name="">\My Documents\OMRON FH</user>
	Launch the File Explorer and select an image file.

● Image control section





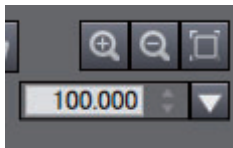

Button	Description
	Performs continuous measurement of images. In the case of camera images, continuously measures and displays camera images. In the case of logging images, continuously measures and displays images in the logging folder. In the case of file images, continuously measures and displays images in the folder. When logging images and file images are selected, continuous measurement is stopped after all images are measured.

Button	Description
	Stops continuous measurement.
	Measures and displays the previous image.
	Measures and displays the next image.
	Saves the latest image in a file.

● Image size control section



This allows you to enlarge or reduce the selected image.

Button	Description
	Enlarges the image. Image display is enlarged in 20% steps. (Upper limit: 1600%)
	Reduces the image. Image display is reduced in 20% steps. (Lower limit: 1%)
	Makes the image fit the display frame
	Enlarges or reduces the image.

● Data save

This saves the settings data to non-volatile memory of the FH/FHV sensor.

● Measure

Performs a single measurement.

The measurement process is performed for the image that is currently displayed.

● Test measurement settings

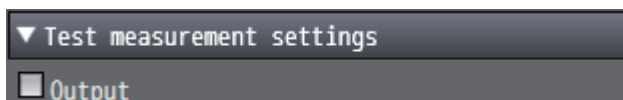

Item	Description
Output	Outputs the measurement results to an external device when test measurement is performed.

● Flow

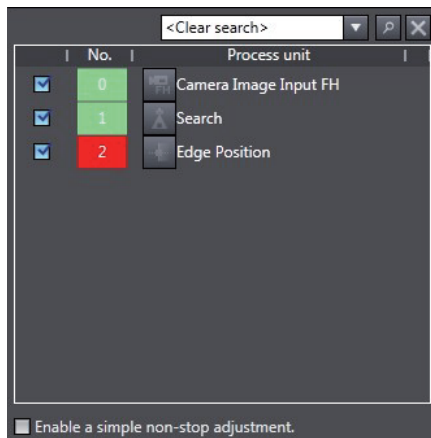

This displays the processing flow for the relevant line or current scene.

If a processing unit displayed in the list is selected, the following display information is linked and so changes accordingly.

- Image display information
- Detailed result display information

If multiple images are displayed, the display information of the image with the focus on it changes.

If a processing unit is searched in the search area, the focus moves to the found processing unit.

Item	Description
Search	Searches for the specified processing unit from within the processing flow.
Flow list	Displays the processing flow for the relevant line or current scene.

With this tool, it is possible to select a processing unit to be used for measurement. The measurements whose processing units with the checkmark removed will not be performed.

Check **Enable Simplified Non-stop Adjustment** to adjust the judgement conditions for each processing unit. The judgement condition editing pane Opens by the following methods:

- Select **Edit** from the context menu of the relevant processing unit within the measurement flow
- Click the icon of the relevant processing unit

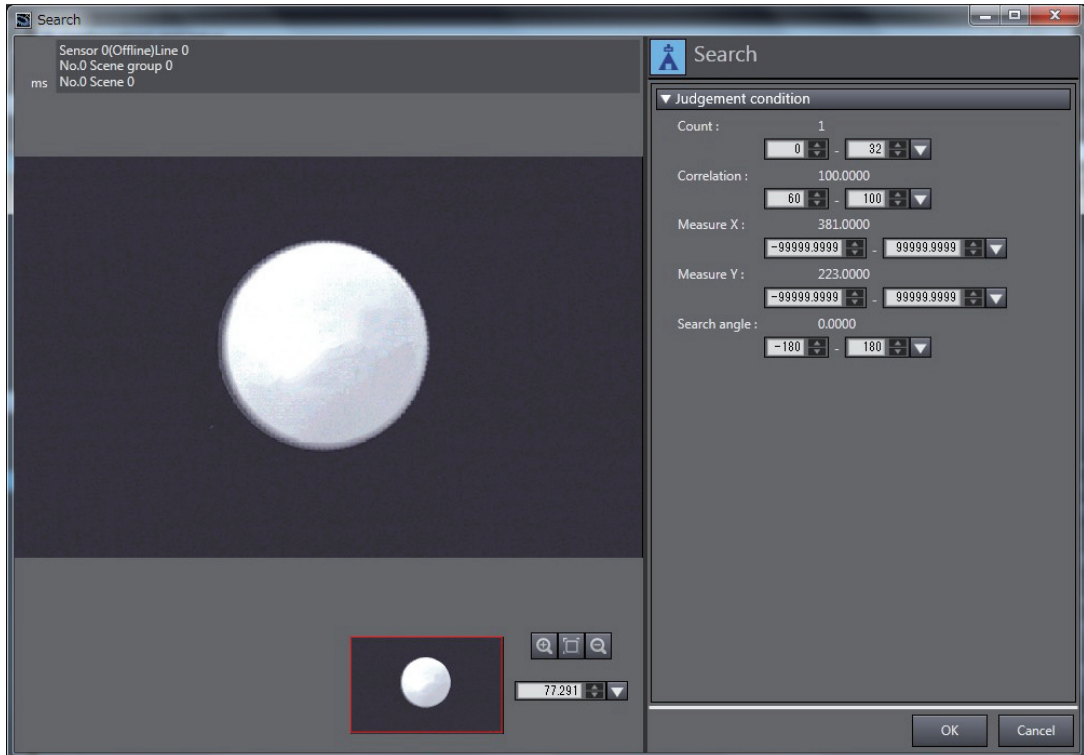

● Detail result

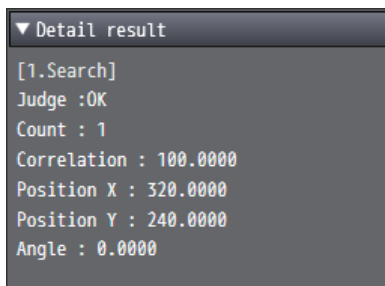

This displays the results for the processing unit selected in the flow.

● Image display settings

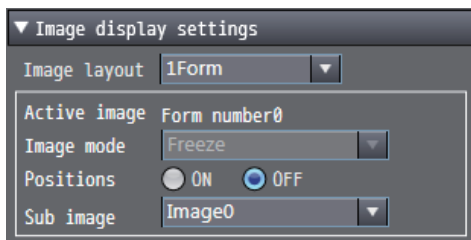

Item	Description
Image layout	Selects the number of images to display. Selection items: 1Form, 2Form, and 4Form
Image mode	Selects the image mode for the image with the focus on it. Selection items: Through, Freeze, and NG image
Positions	Selects position list display for the image with the focus on it. Selection items: OFF and ON

Item	Description
Sub image	Selects the sub image number for the image with the focus on it. Available sub-image numbers vary depending on the processing item. Select items: Image0, Image1,..., image31

This sets the displays settings for images displayed in the image display area.

● Scene maintenance area

Clicking the scene maintenance item bar opens the scene maintenance window.

This screen allows you to manage and switch the scene group data and scene data.

For details on the specifications, refer to *2-5 Basic Operations of Scene Data* on page 2-32.

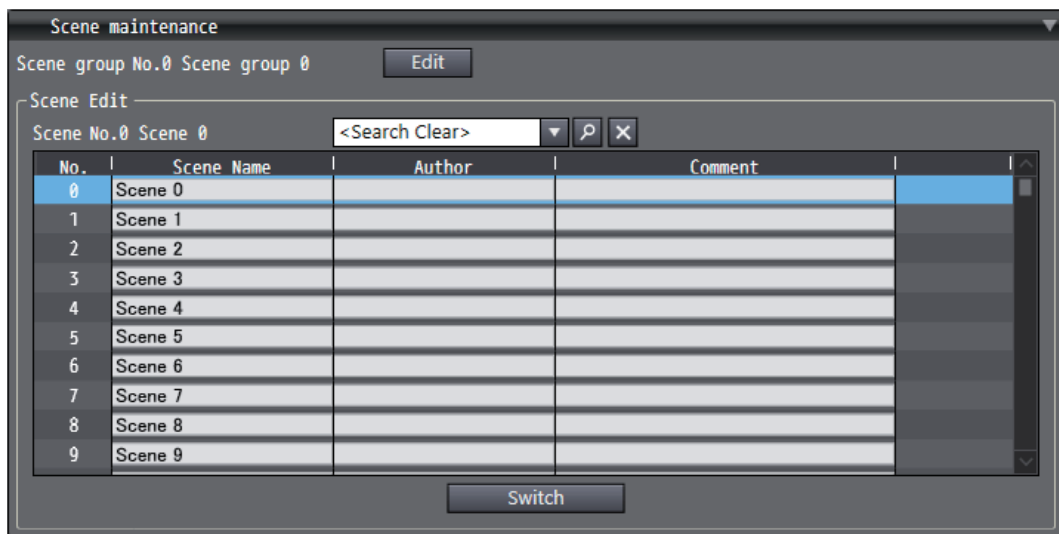

Scene data editing screen

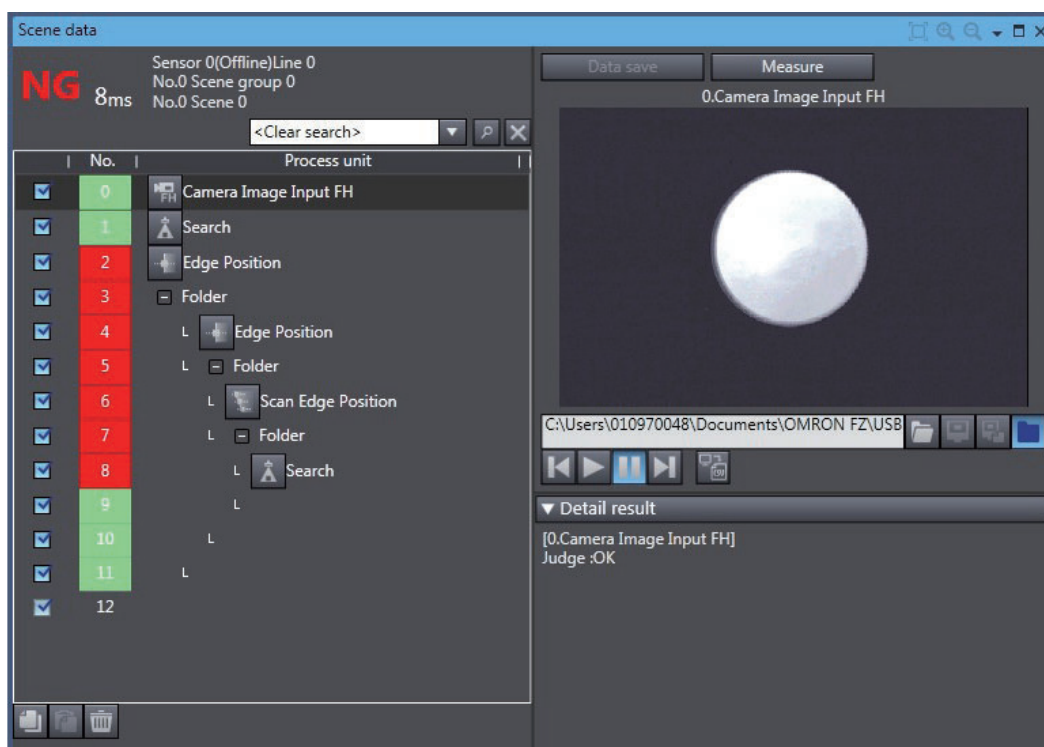

This editing screen allows you to build the processing unit flow.

A new processing unit can be added to the flow by dragging and dropping any processing unit in the Toolbox on to the list.

It is also possible to check the image that is the measurement target, and the measurement results for each processing unit.

● Flow display

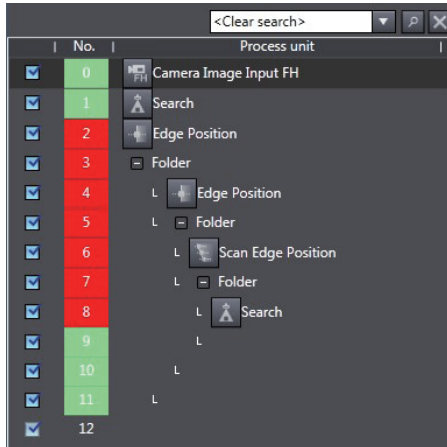

This displays the processing flow for the relevant line or current scene.

Each editing process (adding, copying, deleting, etc.) of the processing units in the flow can be performed.

Item	Description
Search	Searches for the specified processing unit from within the processing flow.
Flow list	Displays the processing flow for the relevant line or current scene.

The registered processing units are displayed in the flow list.

With this tool, it is possible to select a processing unit to be used for measurement.

The measurements whose processing units with the checkmark removed will not be performed.

● Data save

This saves the settings data to non-volatile memory of the FH/FHV sensor.

● Transfer data

This transfers the settings for line 0 to line 1.

The button is displayed only when the operation mode is in Non-stop Adjustment Mode.

● Non-stop data transfer

This transfers the settings for line 1 to line 0.

The button is displayed only when the operation mode is in Non-stop Adjustment Mode.

For details on *Transfer data* and *Non-stop data transfer*, refer to *Setting the Operation Mode - Non-stop Adjustment Mode* in *Vision System FH/FHV Series User's Manual (Cat. No. Z365)*.





● Measure

Performs a single measurement.

The measurement process is performed for the image that is currently displayed.





● File selection section



Button	Description
	Displays camera images. Selection is not possible when offline.
	Displays logging images. Selection is not possible when offline.
	Displays file images. When online, displays images in the RAMDisk or external memory, i.e. USB flash drive. When off-line, displays images in the following folder on the computer. C:\Documents and Settings\ <user documents\omron="" fh<="" name>\my="" td=""> </user>
	Launch the File Explorer and select an image file.

● Image control section



Button	Description
	Performs continuous measurement of images. In the case of camera images, continuously measures and displays camera images. In the case of logging images, continuously measures and displays images in the logging folder. In the case of file images, continuously measures and displays images in the folder. When logging images and file images are selected, continuous measurement is stopped after all images are measured.
	Stops continuous measurement.
	Measures and displays the previous image.
	Measures and displays the next image.
	Saves the latest image in a file.

● Detail result

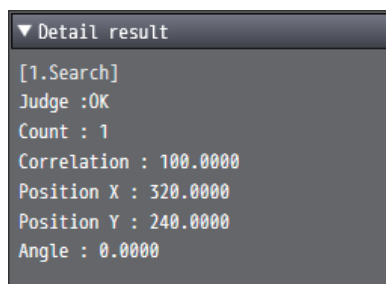

This displays the results for the processing unit selected in the flow.

System data editing screen

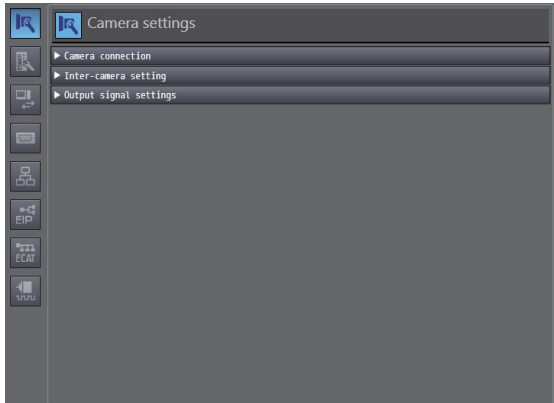

This editing screen allows you to set the system data.

System data is managed on a group basis and the editing items for each group are displayed by clicking the corresponding icon.

No.	Name
1	Icon
2	Group name display area
3	Editing item display area

For details on each group, refer to *8-5 Changing the System Environment* on page 8-8.

Tool settings editing screen

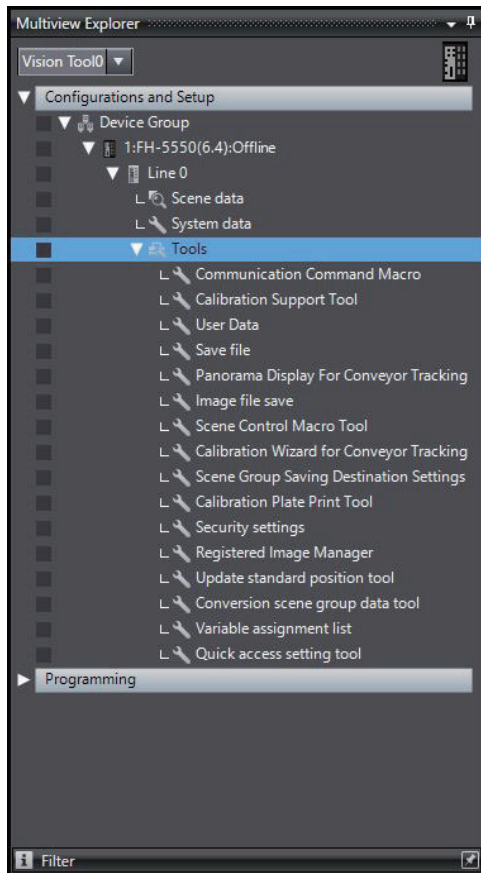

The tool settings editing screen displays the editing screens of the following tools. For details on each tool, refer to *Section 8 Other Useful Functions* on page 8-1.

Tool	Functional Overview
Communication Command Macro	This allows you to set the communication command macro.
Calibration Support Tool	This allows you to check the calibration settings.
User Data	Allows you to edit the user data, set the initial settings, and enter a comment that describes the data.
Save file	Saves the image data to a file.
Conveyor Panorama Display	This tool is used to display a panoramic composition of workpieces being carried by conveyor. *1
Image file save	With this tool, it is possible to save logged images and image files that are saved in the Image Sensor to a RAM disk or external memory device in FH/FHV Vision Sensor, or to a computer.
Scene Control macro tool	With this tool, it is possible to supplement and expand measurement flow and scene control.
Conveyor Calibration Wizard	This tool is used for conveyor tracking applications. This tool is used for conveyor tracking applications to reciprocally convert different coordinates for image sensor, conveyor, and robots by giving instructions in a wizard-style. *1
Scene Group Saving Destination Settings	With this tool, it is possible to set the storage location of scene group data.

Tool	Functional Overview
Calibration Plate Print	This tool is used for conveyor tracking applications. This tool is used for conveyor tracking applications to print Calibration Pattern.*1
Security settings	With this tool, it is possible to restrict access to FH/FHV Vision Image Sensor to specific users and user groups.
Registered image Manager	With this tool, it is possible to save images used for model registration and reference registration as registration images. The saved images can be used for re-registration and adjustment of reference positions.
Update standard position tool	With this tool, it is possible to set or change the reference position for more than one processing unit that is specified in the measurement flow.
Conversion scene group data tool Edit	With this tool, it is possible to create a scene group that has more than or equal to 129 scenes.
Variable assignment list	Displays the assignment list of the System variables and Scene variables registered in the FH/FHV.
Quick access setting tool	With this tool, it is possible to set the quick access "Ident name", "Absolute path", and "Display name". By setting the quick access, you can select the quick access when specifying the path of the file or folder. By setting for each environment, various paths can be set without paying attention to the environment-dependent drive configuration.

*1. This function is applicable to the Conveyor Tracking Calibration Application.
For details, refer to *Vision Sensor FH series Conveyor Tracking Application Programming Guide (Cat. No. Z368)*.

2-4-6 Toolbox

The Toolbox displays a list of the processing units that can be used.

When the scene editing screen is displayed in the Edit Pane, you can add a processing unit by selecting any processing unit and dragging and dropping it onto the flow list in the scene editing screen.

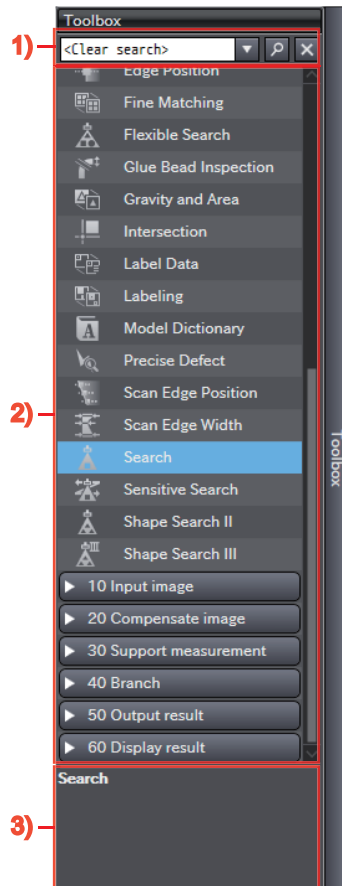

No.	Item	Operation
1	Processing item search window	Searches for processing items.
2	Processing item area	Displays the available processing units.
3	Guidance	Displays the available processing units.

2-5 Basic Operations of Scene Data

An FH/FHV vision sensor can handle multiple scene data.

You can perform operations such as switching, copying, and deleting scenes with the scene maintenance functions in the scene maintenance window.

Right-click **Line X** in the Multiview Explorer and select **Scene maintenance screen** from the menu. Click **Scene maintenance** and show **Scene maintenance** Pane.

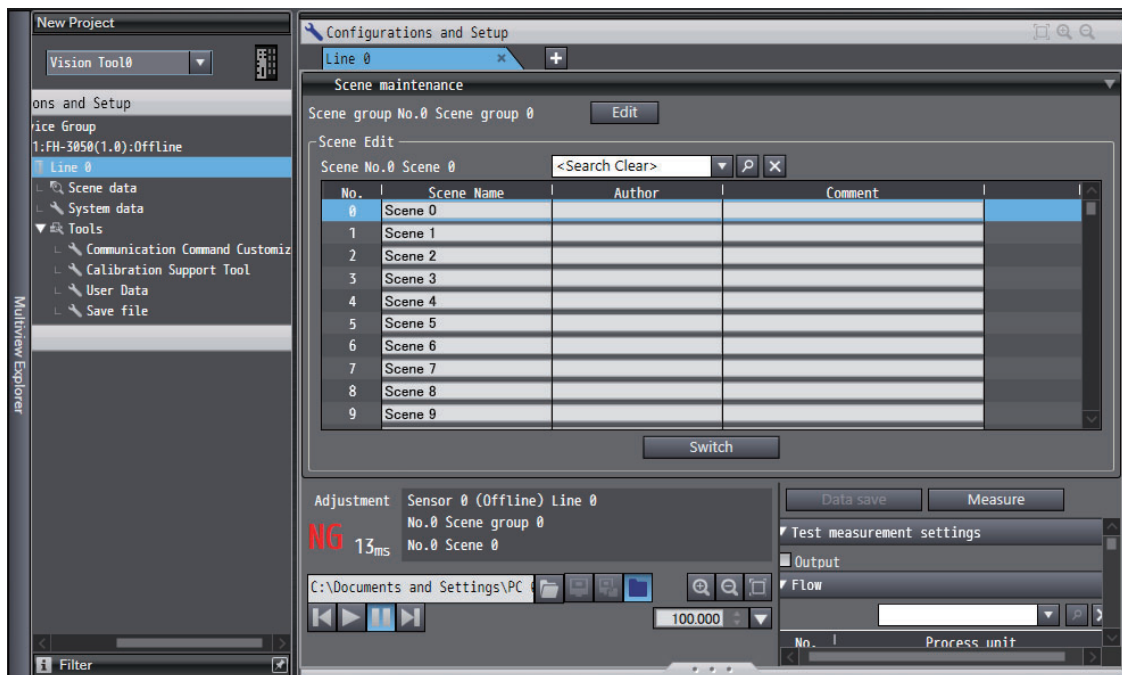

Additional Information

Project data that was edited offline can be transferred to the FH/FHV vision sensor. For details on how to transfer project data, refer to *3-4 Synchronizing Project Data and Sensor Setting Data* on page 3-7.

2-5-1 Switching Scenes

You can switch scenes by selecting the target scene in the scene list and then clicking the **Switch** button.

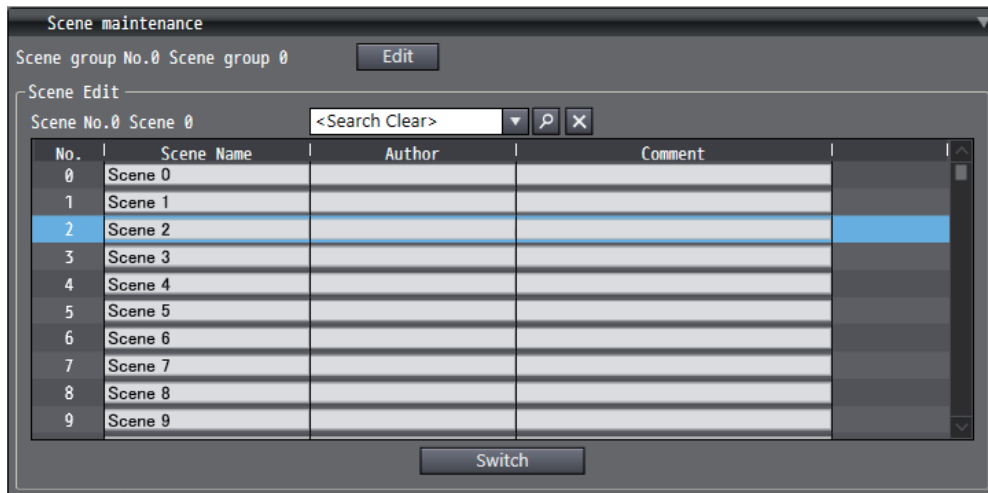

When scene switching is performed, the scene data editing screen is closed automatically if it is open in the Edit Pane.

2-5-2 Managing Scenes

Right-clicking a target scene in the scene list displays the following menu. Select the menu item for the operation you wish to perform.

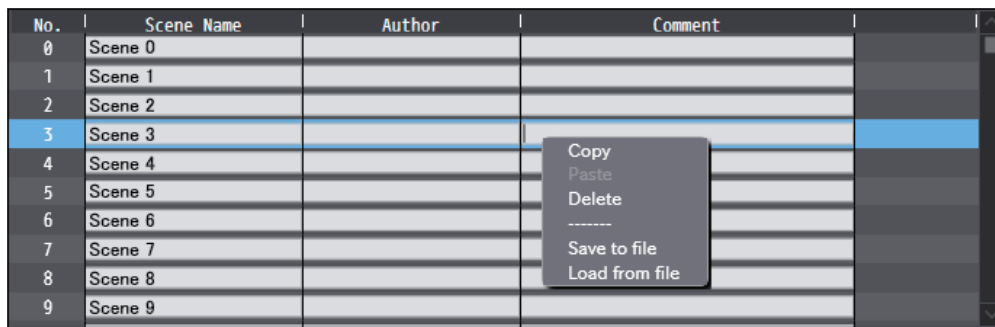

item	Description
Copy	Copies the selected scene.
Paste	Pastes the copied scene.
Delete	Clears the selected scene.
Save to file	Saves the selected scene as a scene data file to the folder on the computer. The save file format can be selected from either binary scene data (file extension: SCN), or CSV. Select CSV to output a list of settings with the <i>Set/Get</i> attribute to the saved file. (Settings with the <i>Set only</i> and <i>Get only</i> attribute cannot be output.) The function to output CSV files outputting by selecting Save to file and the Settings download and upload tools function for the FH/FHV vision sensor are the same. For details, refer to <i>Vision System FH/FHV Series User's Manual (Cat. No. Z365)</i> .
Load from file	Loads the Scene data file stored in computer folder. A Scene data file in CSV format also can be loaded.

2-5-3 Entering Scene Information

The scene list displays the following information.

No.	Scene Name	Author	Comment
0	Scene 0		
1	Scene 1		
2	Scene 2		
3	Scene 3		
4	Scene 4		
5	Scene 5		
6	Scene 6		
7	Scene 7		
8	Scene 8		
9	Scene 9		

Item	Description
Scene Name	Displays the scene name. (Maximum of 15 characters)
Author	Displays the author name. (Maximum of 15 characters)
Comment	Displays the comment. (Maximum of 255 characters)

Each item in the list can be directly edited.

2-5-4 Searching for a Scene

You can search for a scene in the list by entering any scene name in the search box and then clicking the search button (🔍). Clicking the search clear button (✖) clears the search results.



2-5-5 Switching Scene Groups

Clicking the scene group editing button displays the scene group editing window.

You can switch scene groups by selecting the target scene group in the list and then clicking the **Switch** button.

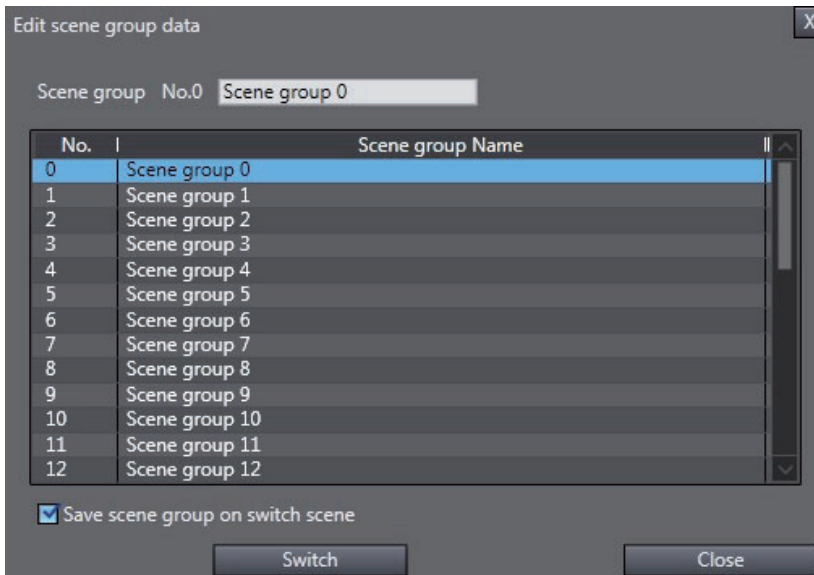

When scene switching is performed, the scene data editing screen is closed automatically if it is open in the Edit Pane.

2-5-6 Managing Scene Groups

Right-clicking a target scene group in the scene group list in the scene group editing window displays the following menu.

Select the menu item for the operation you wish to perform.

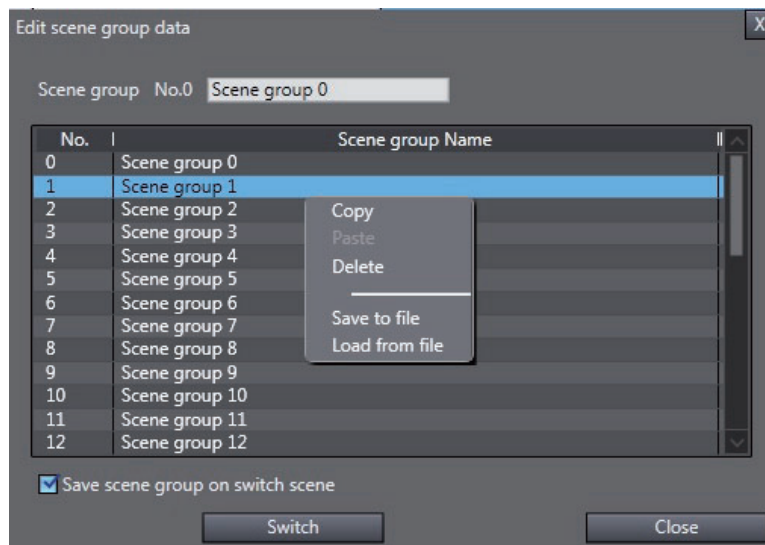

Item	Description
Copy	Copies the selected scene group.
Paste	Pastes the copied scene group.
Delete	Clears the selected scene group.
Save to file	Selected Scene group is saved the following folder on the computer. C:\Documents and Settings\ <user documents\omron="" fh<="" name>\my="" td=""> </user>
Load from file	Scene group data file is saved the following folder on the computer. C:\Documents and Settings\ <user documents\omron="" fh<="" name>\my="" td=""> </user>

2-5-7 Entering Scene Group Information

The scene group list displays the following information.

Item	Description
Scene group Name	Displays the scene group name.

The current scene group name can be edited.

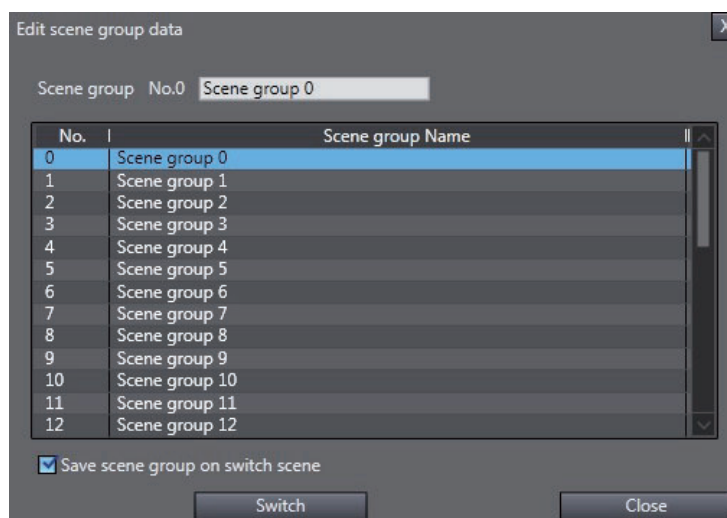

2-6 Basic Operations of Flow Editing

This section describes how to edit the flow.

Edit the flow in the **scene data editing screen**. For details on the scene data editing screen, refer to *Scene data editing screen* on page 2-25.

You can open the scene data editing screen in the Edit pane by double-clicking **scene data**, or by right-clicking it and selecting **Edit** from the menu.

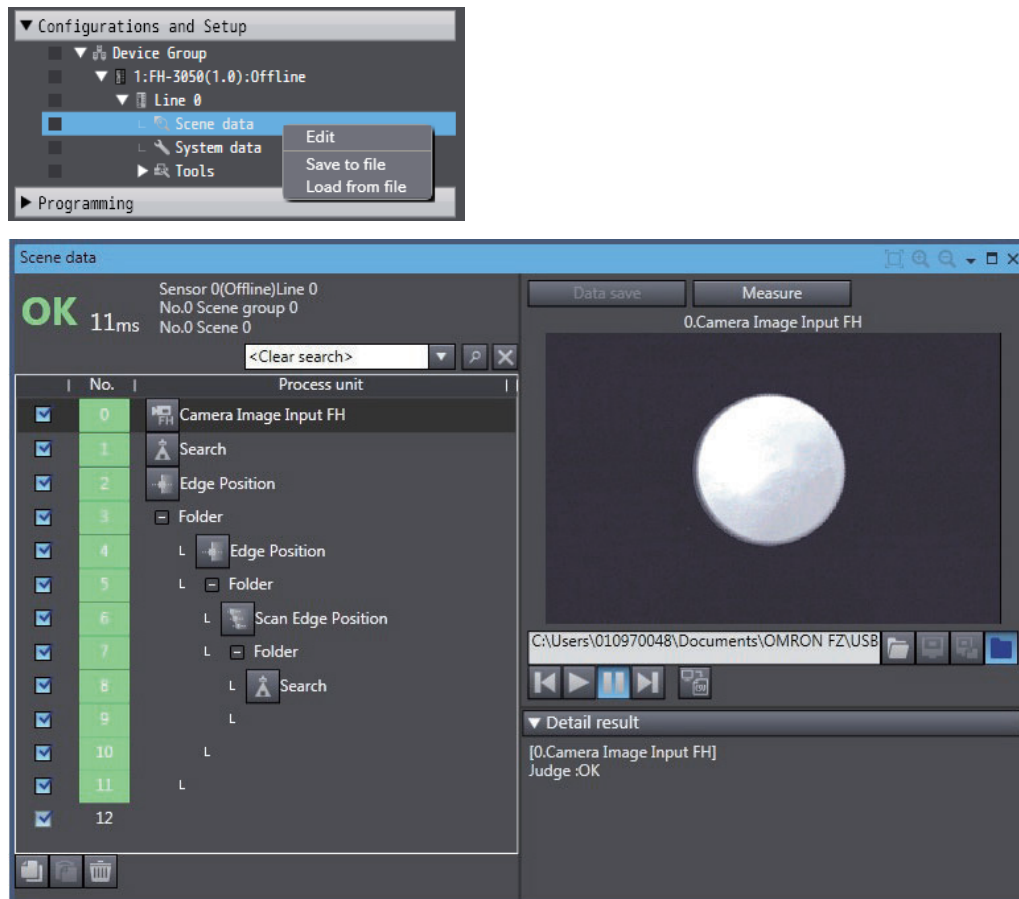

2-6-1 Adding a Processing Unit

When you wish to add a new processing unit to the flow, first select any processing unit from the Tool-box.

Then drag the selected processing unit to the place you wish to insert it in the flow list.

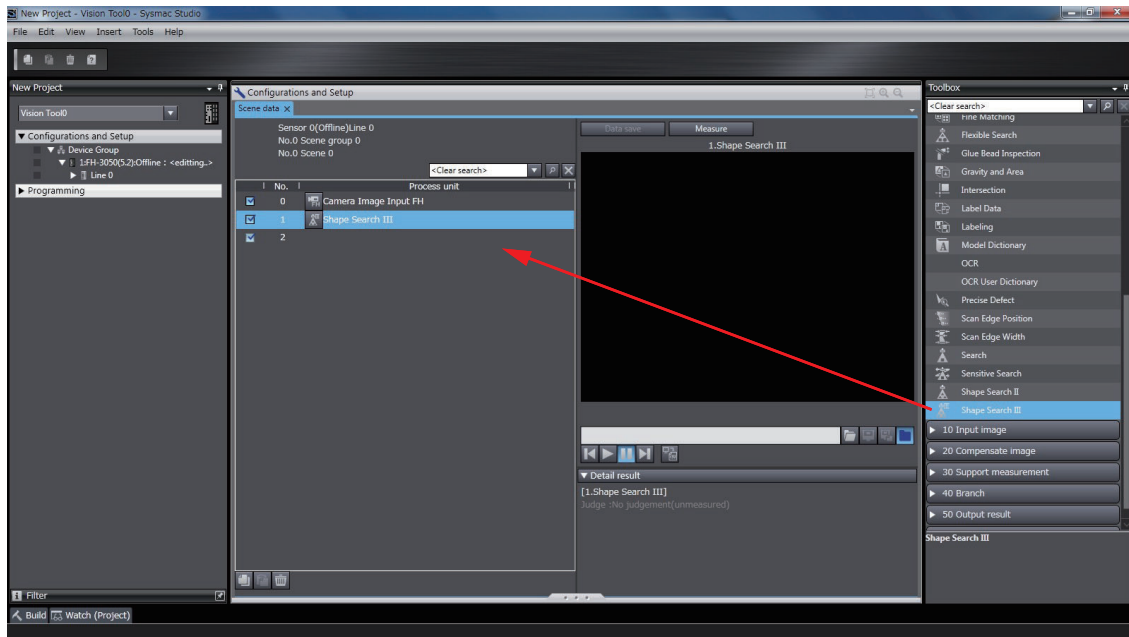

2-6-2 Managing Processing Units

Right-clicking a target processing unit in the flow list displays the following menu. Select the menu item for the operation you wish to perform.

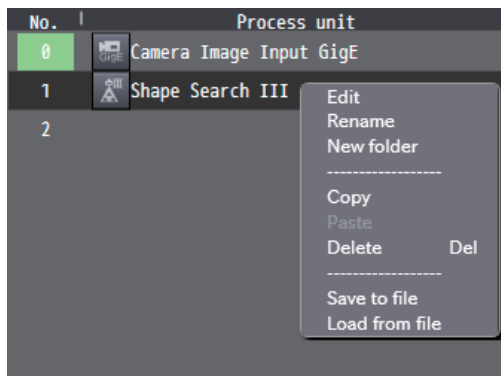



Item	Description
Edit*1	Opens the processing unit editing screen.
Rename	Changes the name of the processing unit.
New folder	Inserts a folder unit.
Copy	Copies the selected processing unit.
Paste	Pastes the copied processing unit.
Delete	Clears the selected processing unit.
Save to file	Saves the setting data of processing units to the specified file. When on-line, saves the selected Scene group as a file to the RAMDisk or the external memory, i.e. USB flash drive. When off-line, saves it to the described following folder on the computer. C:\Documents and Settings\ <user name="">\My Documents\OMRON FH</user>

Item	Description
Load from file	Loads the setting data of processing units from the specified file. When on-line, loads a Scene data file in the RAMDisk or the external memory, i.e. USB flash drive from the selected Scene group. When off-line, loads the Scene data file in the described following folder on the computer. C:\Documents and Settings\ <user name="">\My Documents\OMRON FH</user>

- *1. If the processing item is not supported in the **edit** operation, the following message appears.
The Procltem has not been supported.

Menu buttons

Button	Description
	Copies the processing unit with the focus on it.
	Pastes the copied processing unit.
	Deletes the processing unit with the focus on it.

Display is hierarchical in the flow list when the following processing units are used.

- Folder unit
- Parallelize unit
- Parallelize task unit

<No folder unit>

No.	Process unit
0	Camera Image Input GigE
1	Shape Search III
2	Search
3	Scan Edge Position
4	Edge Position
5	

<Folder unit layer 1>

No.	Process unit
0	Camera Image Input GigE
1	Shape Search III
2	Folder
3	L Search
4	L Scan Edge Position
5	L Edge Position
6	L Edge Position
7	L
8	

<Folder unit layer 2>

No.	Process unit
0	Camera Image Input GigE
1	Shape Search III
2	Folder
3	L Search
4	L Scan Edge Position
5	L Edge Position
6	L Folder
7	L Edge Position
8	L Edge Position
9	L

<Parallelize unit>

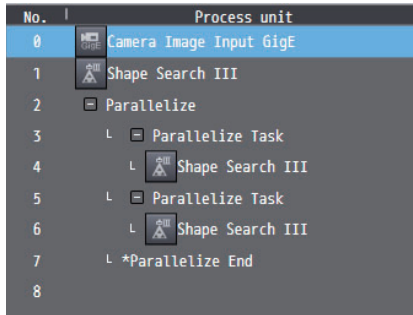

2-6-3 Searching for a Processing Unit

You can search for a processing unit in the flow list by entering any processing unit name in the search box and then clicking the search button (🔍). Clicking the search clear button (✖) clears the search results.



2-7 Function List

2-7-1 List of Functions Provided with the FH/FHV Tool

The following shows the functions provided with the FH/FHV tool and the usage conditions.

Yes: Supported, No: Not supported

Classification	Item	Function	When On-line Editing	When Off-line Editing	
Project management	Menu	File	Close	Yes	Yes
			Save	Yes	Yes
			Save As	Yes	Yes
			Import	No	Yes
			Export	No	Yes
			Exit	Yes	Yes
		Edit	Copy	No	Yes
			Paste	No	Yes
			Delete	Yes	Yes
		View	Multiview Explorer	Yes	Yes
			Toolbox	Yes	Yes
			Smart Project Search	Yes	Yes
			Recently Closed Windows	Yes	Yes
			Clear Recently Closed Windows History	Yes	Yes
			Reset Window Layout	Yes	Yes
		Insert	Controller	Yes	Yes
			Displacement Sensor	Yes	Yes
			Vision Sensor	Yes	Yes
			Slave Terminal	Yes	Yes
			HMI	Yes	Yes
Tools	Options	Yes	Yes		
Help	Help Contents	Yes	Yes		
	About Sysmac Studio	Yes	Yes		
Edit operations	Toolbar	Copy	No	Yes	
		Paste	No	Yes	
		Delete	Yes	Yes	
		Help	Yes	Yes	
Parameter settings	Multiview	Device Group	Add - FH/FHV	Yes	Yes
			Rename	Yes	Yes

Classification	Item	Function	When On-line Editing	When Off-line Editing		
		Type	Edit	Yes	Yes	
			Change Version	No	Yes	
			Delete	Yes	Yes	
			Restart	Yes	Yes	
			Online	No	Yes	
			Offline	Yes	No	
			Stop offline editor	No	Yes	
		Line X	Monitor window	Yes	Yes	
			Scene maintenance window	Yes	Yes	
			Save data	Yes	No	
			Copy	No	Yes	
			Paste	No	Yes	
			Rename	Yes	Yes	
			Save to file	Yes	Yes	
			Load from file	Yes	Yes	
			Print	Yes	Yes	
		Scene data	Edit	Yes	Yes	
			Copy	No	Yes	
			Paste	No	Yes	
			Delete	Yes	Yes	
			Save to file	Yes	Yes	
		System data	Edit	Yes	Yes	
			Save to file	Yes	Yes	
			Load from file	Yes	Yes	
		Tools	Communication Command Macro	Edit	Yes	Yes
				Copy	No	Yes
				Paste	No	Yes
				Delete	Yes	Yes
				Save to file	Yes	Yes
			Load from file	Yes	Yes	
			Calibration Support Tool	Edit	Yes	Yes
			User Data	Edit	Yes	Yes
			Save file	Edit	Yes	Yes
Conveyor Panorama Display	Edit		Yes*2	Yes*2		
Image file save	Edit		Yes	Yes		
Scene Control macro tool	Edit		Yes	Yes		
Conveyor Calibration Wizard	Edit		Yes*2	Yes*2		

Classification	Item	Function		When On-line Editing	When Off-line Editing	
			Scene Group Saving Destination Settings	Edit	Yes	No
			Calibration Plate Print	Edit	Yes*2	Yes*2
			Security settings	Edit	Yes	Yes
			Registered image Manager	Edit	Yes	Yes
			Update standard position tool	Edit	Yes	Yes
			Conversion scene group data tool Edit	Edit	Yes	Yes
			Variable assignment list	Edit	Yes	Yes
			Quick access setting tool	Edit	Yes*2	Yes*2
			Error log management tool	Edit	Yes	No
Measurement control	Edit Pane	Online measurement	Camera images	Yes	No	
			File images (File images in the vision sensor)	Yes	No	
			Logging images	Yes	No	
			File images (File images in the computer)	No	Yes	
		Simulation*1	Integrated simulation	No	Yes	

*1. Simulation is available only when editing an NJ/NX/NY Project.

*2. FHV is not supported.

2-7-2 Comparison with FH Series Unit Functions

The following table shows the main differences between the functions provided with an FH series device and the FH tool.

Yes: Supported, No: Not supported

Classification	Item	Sysmac Studio	FH
Project management	Data management for a single FH vision sensor	Yes	Yes
	Data management for all devices	Yes	No
	Screen customization and screen layout control	No	Yes
	Creating and displaying dedicated dialog boxes	No	Yes

Classification	Item	Sysmac Studio	FH
Tools	Communication Command Macro	Yes	Yes
	Save file	Yes	Yes
	Calibration Support Tool	Yes	Yes
	NG analyzer	No	Yes
	User Data	Yes	Yes
	Security settings	Yes	Yes
	Downloading and uploading setting values	No	Yes
	Image file save	Yes	Yes
	Registered image Manager	Yes	Yes
	Flow viewer	No	Yes
	Update standard position tool	Yes	Yes
	Conversion scene group data tool Edit	Yes	Yes
	Scene Group Saving Destination Settings	Yes	Yes
	Scene Control macro tool	Yes	Yes
	Custom dialog tool	No	Yes
	Custom dialog	No	Yes
	Configuration Copy	No	Yes
	Line Maintenance	No	Yes
	Variable assignment list	Yes	No
	Quick access setting tool	Yes	Yes
	Setting Comparer	No	Yes
	Conveyor Panorama Display	Yes ^{*1}	No
	Conveyor Calibration Wizard	Yes ^{*1}	No
Calibration Plate Print	Yes ^{*1}	No	
Error log management tool	Yes	Yes	
Simulation	Single simulation	Yes	Yes
	Integrated simulation	Yes	No

*1. For details, refer to *Vision Sensor FH series Conveyor Tracking Application Programming Guide (Cat. No. Z368)*.

2-7-3 Comparison with FHV Series Unit Functions

The following table shows the main differences between the functions provided with an FHV series device and the FHV tool.

Yes: Supported, No: Not supported

Classification	Item	Sysmac Studio	FHV	FHV Simulator
Project management	Data management for a single FHV vision sensor	Yes	Yes	Yes
	Data management for all devices	Yes	No	No
	Screen customization and screen layout control	No	Yes	Yes
	Creating and displaying dedicated dialog boxes	No	Yes	Yes

Classification	Item	Sysmac Studio	FHV	FHV Simulator
Tools	Communication Command Macro	No	No	No
	Save file	Yes	Yes	Yes
	Calibration Support Tool	Yes	No	Yes
	NG analyzer	No	No	No
	User Data	No	No	No
	Security settings	Yes	Yes	Yes
	Downloading and uploading setting values	No	No	Yes
	Image file save	No	No	No
	Registered image Manager	Yes	Yes	Yes
	Flow viewer	No	No	Yes
	Update standard position tool	No	No	No
	Conversion scene group data tool Edit	Yes	No	Yes
	Scene Group Saving Destination Settings	No	No	No
	Scene Control macro tool	No	No	No
	Custom dialog tool	No	No	Yes
	Custom dialog	No	Yes	Yes
	Configuration Copy	No	No	Yes
	Line Maintenance	No	No	No
	Variable assignment list	Yes	No	No
	Quick access setting tool	No	No	No
	Setting Comparer	No	No	No
	Conveyor Panorama Display	No	No	No
	Conveyor Calibration Wizard	No	No	No
Calibration Plate Print	No	No	No	
Error log management tool	Yes	Yes	No	
Simulation	Single simulation	Yes	Yes	Yes
	Integrated simulation	Yes	No	No

2-8 Precautions on Synchronization through an NJ/NX/NY-series Controller

The contents of the Sysmac Studio project data and the data being synchronized vary depending on the connection method (i.e., Ethernet direct connection or connection through an NJ/NX/NY-series Controller) between the FH/FHV sensor and the computer that runs the Sysmac Studio. Particularly, the settings data for the FH/FHV sensor cannot be synchronized via an NJ/NX/NY-series Controller. This section describes precautions on performing the system synchronization from the System Studio via an NJ/NX/NY-series Controller. For the overview, refer to *1-2-2 Project Data Handling in Different System Configurations* on page 1-4.

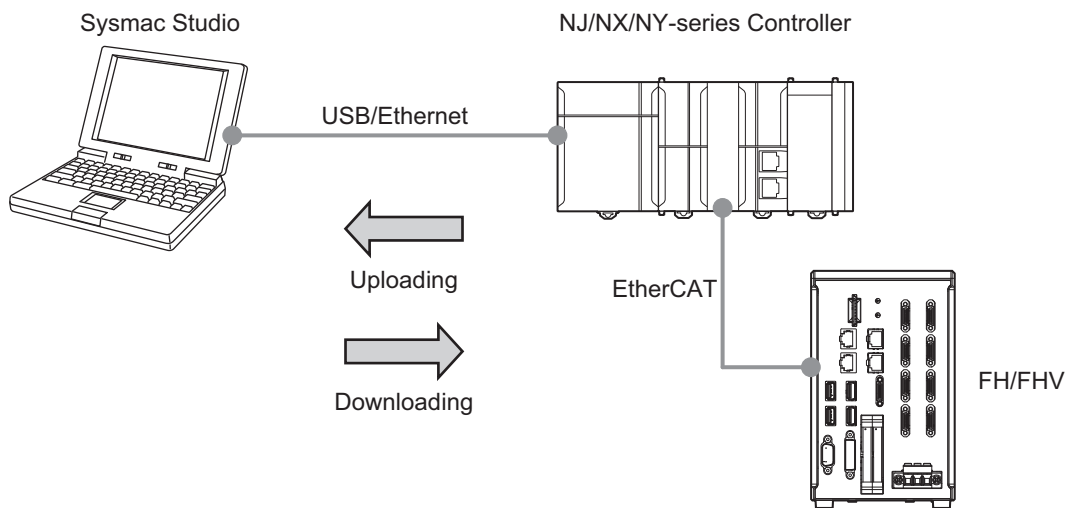

Additional Information

The sensor data unit (FHV-SDU30) is required for EtherCAT connection between NJ/NX/NY-series Controller and FHV sensor.

For details, refer to *FHV Series Smart Camera Setup Manual (Cat. No. Z408)*.

2-8-1 Synchronized Project Data

The Sysmac Studio manages the settings data for the FH/FHV sensor as a part of the project data. (Refer to *1-2-1 Project data* on page 1-3.)

The data size of the FH/FHV sensor settings varies depending on the created scenes and measurement flows. (Refer to *Memory Usage Guidance For Processing Items* in *Vision System FH/FHV Series User's Manual (Cat. No. Z365)*.)

Because of this, the settings data for the FH/FHV sensor cannot be synchronized via an NJ/NX/NY-series Controller.

There are following methods to synchronize the settings data for the FH/FHV sensor with the data in the Sysmac Studio.

1. Directly connect the FH/FHV sensor to the computer that runs the Sysmac Studio via Ethernet
Refer to *3-4 Synchronizing Project Data and Sensor Setting Data* on page 3-7.

2. Use the external memory

The procedures are described in the following sections:

- 2-8-2 Saving and Loading the Settings Data for the FH/FHV Sensor Controller on page 2-46
- 2-8-3 Transferring Data from the Sysmac Studio on page 2-47
- 2-8-4 Transferring Data to the Sysmac Studio on page 2-48

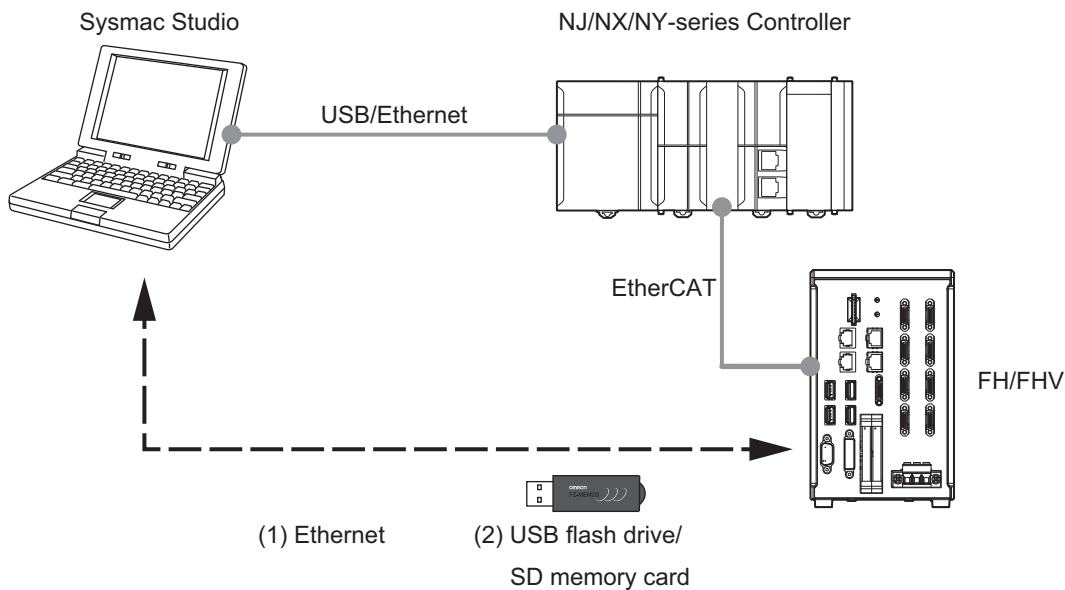

2-8-2 Saving and Loading the Settings Data for the FH/FHV Sensor Controller

This section describes procedures for saving and loading the settings data for the FH/FHV sensor using the external memory.

The following procedures describe how to save and load the settings data for the FH/FHV sensor that is in the FH/FHV sensor to the external memory.

Save and load following four types of the settings data individually.

1. System + Scene group 0 data

Refer to the following:

- *Saving Settings Data to the Controller RAM Disk or an External Memory Device in Vision System FH/FHV Series User's Manual (Cat. No. Z365)*
- *Loading Settings Data from the Controller RAM Disk or an External Memory Device to the Sensor Controller in Vision System FH/FHV Series User's Manual (Cat. No. Z365)*

2. Data for scene groups 1 to 31

Refer to the following:

- *Saving Settings Data to the Controller RAM Disk or an External Memory Device in Vision System FH/FHV Series User's Manual (Cat. No. Z365)*
- *Loading Settings Data from the Controller RAM Disk or an External Memory Device to the Sensor Controller in Vision System FH/FHV Series User's Manual (Cat. No. Z365)*

3. Communications command macro data

Refer to *Saving and Loading Programs in Vision System FH series Macro Customize Functions Programming Manual (Cat. No. Z367)*.

4. Security settings data

Refer to *Saving/Loading/Deleting the Security Settings in Vision System FH/FHV Series User's Manual (Cat. No. Z365)*.



Precautions for Correct Use

- If the FH sensor controller is in the Multi-line Random-trigger Mode, the settings data for the FH sensor controller must be saved and loaded for each individual line.
- During saving, do not restart, turn OFF the power supply, or remove the external memory device. Data will be corrupted and the system will not work properly at the next start-up. Be particularly careful if you use **Save to file** for "System + Scene group 0 data" because the data to be saved will also be saved to the flash memory in the Controller at the same time.

2-8-3 Transferring Data from the Sysmac Studio

This section describes the how to download the Sysmac Studio data to the FH/FHV sensor when synchronizing the Sysmac Studio and the FH/FHV sensor.

This section describes the procedures for transferring data from the Sysmac Studio via the external memory.

Use the following procedures to synchronize the data from the Sysmac Studio.

- 1 Save the settings data for the FH/FHV sensor that is in the Sysmac Studio to the external memory.
- 2 Establish an online connection with the NJ/NX/NY-series Controller to transfer the data from the Sysmac Studio to the NJ/NX/NY-series Controller.
- 3 Use the external memory that holds the data saved in Step 1 to load the data to the FH/FHV sensor.

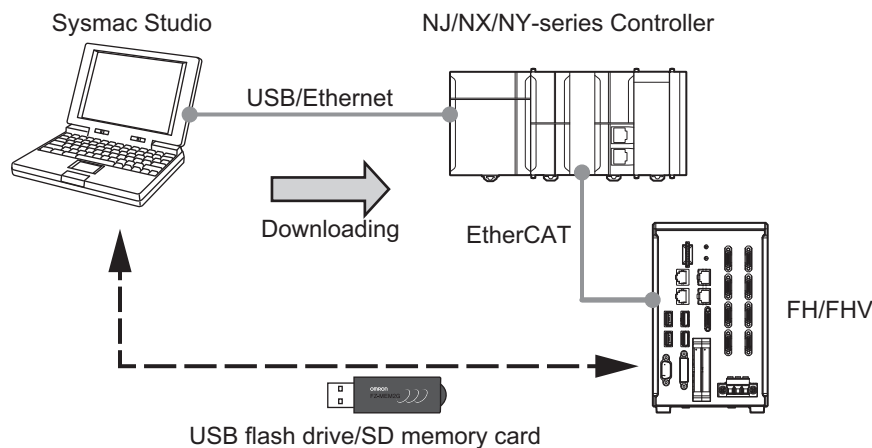

- Procedures for saving the settings data for the FH/FHV sensor that is in the Sysmac Studio (Sysmac Studio to external memory)
Save the data in the Sysmac Studio to the external memory.
Then use the external memory to transfer the data to the FH/FHV sensor.
Refer to 2-4-4 *Multiview Explorer* on page 2-11.
Save following four types of the settings data individually.
 - 1) System + Scene group 0 data
Refer to 8-3 *Using the File Save Tool* on page 8-5.
 - 2) Data for scene groups 1 to 31
Refer to 8-3 *Using the File Save Tool* on page 8-5.
 - 3) Communications command macro data
Refer to 8-1 *Using the Command Customize Setting Tool* on page 8-3.

4) Security settings data

Refer to *8-7 Using the Security Setting Tool* on page 8-11.



Precautions for Correct Use

If the FH/FHV sensor is in the Multi-line Random-trigger Mode, the settings data for the FH/FHV sensor must be saved for each individual line.

- Procedures for transferring the data from the Sysmac Studio to the NJ/NX/NY-series Controller (Sysmac Studio to NJ/NX/NY-series Controller)
Establish an online connection with the NJ/NX/NY-series Controller to transfer the data from the Sysmac Studio to the NJ/NX/NY-series Controller.
Refer to *Sysmac Studio Version 1 Operation Manual (Cat. No. W504)*.
 - 1) Establish an online connection between the NJ/NX/NY-series Controller and the computer that runs the Sysmac Studio.
 - 2) Select **Synchronize** from the **Controller** Menu.
 - 3) Select **Transfer to Sensor**.
- Procedures for transferring the data from the external memory to the FH/FHV sensor (external memory to FH/FHV sensor)
Use the external memory that holds the settings data to load the data to the FH/FHV sensor.
Refer to *2-8-2 Saving and Loading the Settings Data for the FH/FHV Sensor Controller* on page 2-46.

2-8-4 Transferring Data to the Sysmac Studio

This section describes the how to transfer the data in the NJ/NX/NY-series Controller and the FH/FHV sensor to the Sysmac Studio when synchronizing the Sysmac Studio and the FH/FHV sensor.

This section describes the procedures for transferring data from the Sysmac Studio via the external memory.

Use the following procedures to synchronize the data from the Sysmac Studio.

- 1** Save the settings data for the FH/FHV sensor in the FH/FHV sensor from to the external memory.
- 2** Establish an online connection with the NJ/NX/NY-series Controller and transfer the data from the NJ/NX/NY-series Controller to the Sysmac Studio.
- 3** Use the external memory that holds the data saved in Step 1 to load the data to the Sysmac Studio.
- 4** Save the Sysmac Studio project.

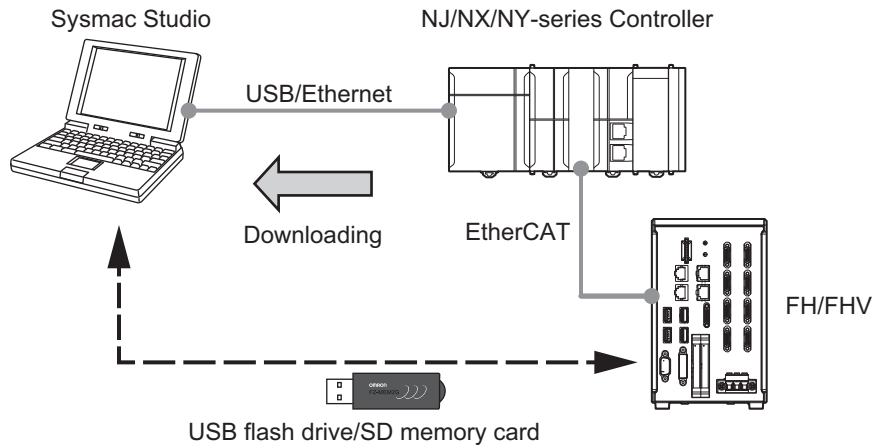

- Saving the settings data for the FH/FHV sensor (FH/FV sensor to external memory)
The following section describes the procedures for saving the settings data for the FH/FHV sensor to the external memory.
Refer to 2-8-2 *Saving and Loading the Settings Data for the FH/FHV Sensor Controller* on page 2-46.
- Procedures for transferring the data from the NJ/NX/NY-series Controller to the Sysmac Studio (NJ/NX/NY-series Controller to Sysmac Studio)
Establish an online connection with the NJ/NX/NY-series Controller and transfer the data from the NJ/NX/NY-series Controller to the Sysmac Studio.
Refer to *Sysmac Studio Version 1 Operation Manual (Cat. No. W504)*.
 - 1) Establish an online connection between the NJ/NX/NY-series Controller and the computer that runs the Sysmac Studio.
 - 2) Select **Synchronize** from the **Controller** Menu.
 - 3) Select **Transfer to computer**.



Precautions for Correct Use

Do not restart the FH/FHV sensor or edit the settings data for the FH/FHV sensor from the Sysmac Studio at the timing when **Transfer to computer** is executed.

The values for the settings data that the FH/FHV sensor manages will be reset to the factory defaults immediately after the execution of **Transfer to computer**. With default values set to the settings data, editing the settings data updates the associated I/O Map with the default values.

Be sure not to restart the FH/FHV sensor before the completion of the data transfer.

Also, be sure not to save the project before restart of the FH/FHV sensor.

If the synchronization with the NJ/NX/NY-series Controller is performed again after the data

transfer to the Sysmac Studio, () in the EtherCAT configurations will be displayed.

This is because the settings data for the FH/FHV sensor has been updated.

If you follow the procedures above, the Sysmac Studio project data matches the data in the NJ/NX/NY-series Controller.

- Procedures for transferring the settings data for the FH/FHV sensor to the Sysmac Studio (external memory to Sysmac Studio)
Loads the settings data for the FH/FHV sensor that is in the external memory to the Sysmac Studio.
Refer to 2-4-4 *Multiview Explorer* on page 2-11.
Load following four types of the settings data individually.
 - 1) System + Scene group 0 data

- 2) Data for scene groups 1 to 31
- 3) Communications command macro data
Refer to 8-1 *Using the Command Customize Setting Tool* on page 8-3.
- 4) Security settings data
Refer to 8-7 *Using the Security Setting Tool* on page 8-11.



Precautions for Correct Use

If the FH sensor controller is in the Multi-line Random-trigger Mode, the settings data for the FH sensor controller must be loaded for each individual line.

● Load the system data and the scene group data

The following procedures describe how to load the system data and the scene group data.

- 1** Insert the external memory to the computer that runs the Sysmac Studio.
- 2** In the Multiview Explorer tree, select the FH/FHV sensor to which you want to load the data.
- 3** Right-click the selected FH/FHV sensor and select **Edit** from the menu.
- 4** Right-click the line number and select **Load from file** from the menu.

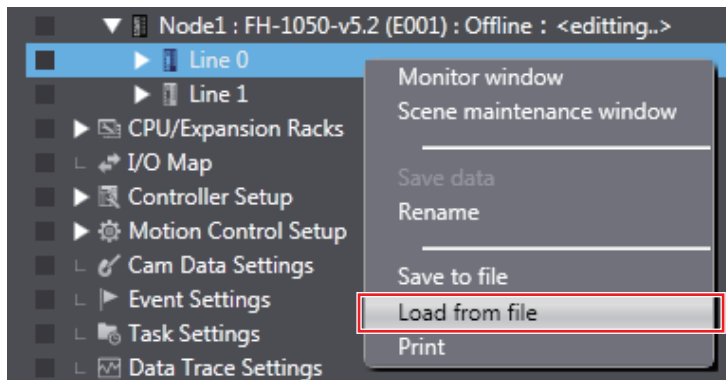

- 5** Right-click the FH/FHV sensor and select **Restart** from the menu.
This operation shows the line with the selected line number in the tree.

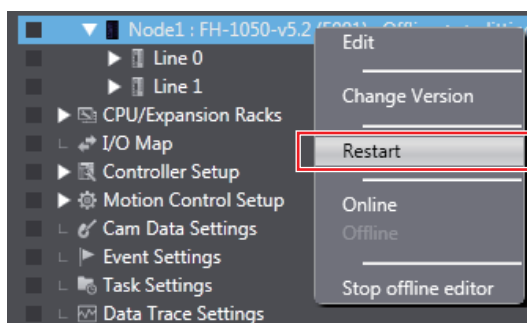

- 6** Repeat steps 4 and 5 for each line.
- 7** After completion of data transfer for all lines for all FH/FHV sensors, save the Sysmac Studio project.

3

Connecting with a Vision Sensor

This section describes how to establish a connection with a vision sensor.

3-1	Connecting with a Vision Sensor	3-2
3-2	Adding FH/FHV Series Vision Sensor on the Network to a Project.....	3-3
3-3	Establishing an Online Connection with a Vision Sensor.....	3-4
3-3-1	Establishing an Online Connection from the Sensor Connection Screen.....	3-4
3-3-2	Establishing an Online Connection from the Multiview Explorer	3-5
3-4	Synchronizing Project Data and Sensor Setting Data	3-7
3-4-1	Transferring Project Data to the Sensor	3-7
3-4-2	Transferring Setting data in the Sensor to a Project	3-9
3-5	Ending a Connection with a Vision Sensor	3-11
3-5-1	Ending a Connection in the Sensor Connection Screen.....	3-11
3-5-2	Ending a Connection in the Multiview Explorer	3-11
3-6	Logging in to a Registered User's Account.....	3-12

3-1 Connecting with a Vision Sensor

To establish an online connection with FH/FHV vision sensor, configure settings and make adjustments, connect directly by Ethernet.

You can also connect via a hub or router.

It is not possible to set and adjust FH/FHV vision sensor via NJ/NX/NY-series Controller.

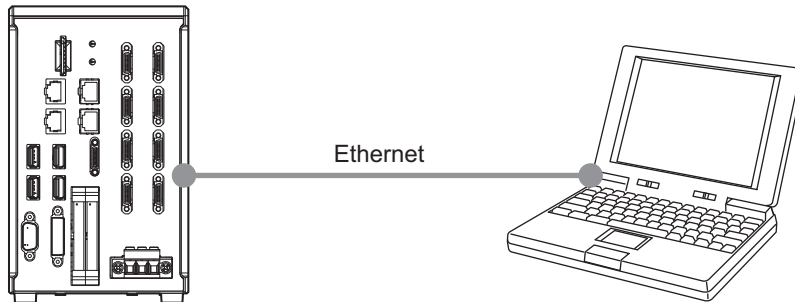

Precautions for Correct Use

- If there is already a different FH/FHV slave device in the project with an established online connection, you will not be able to establish an online connection for a new FH/FHV slave device. First, switch the other FH/FHV slave device from online to offline.
- Do not start the Remote Operation tool while using Sysmac Studio.
- To configure account settings with an FH/FHV vision sensor, you will need to log in to your account while online.

For details on logging in to your account, refer to *3-6 Logging in to a Registered User's Account* on page 3-12.

3-2 Adding FH/FHV Series Vision Sensor on the Network to a Project

When creating a new project or adding FH/FHV vision sensor to a project, select FH/FHV vision sensor on the network.

When connecting to the FH/FHV vision sensor, right-click **Device Group** in the Multiview Explorer and then select **Add - FH** or **Add - FHV**.

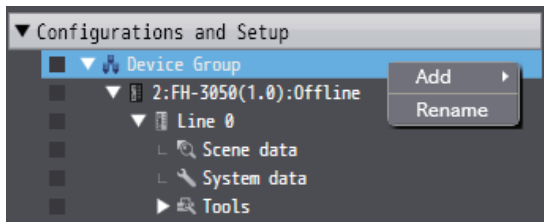

The following sensor selection screen appears.

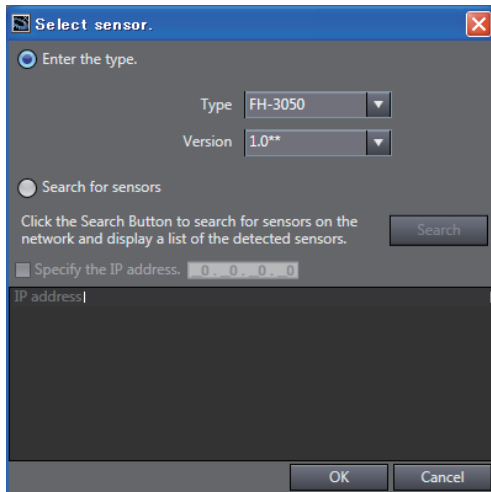

When establishing an online connection, click **Search for sensors** and then click the **Search** button. The found sensors are displayed in a list. Select the sensor you wish to connect to and then click the **OK** button.

If you know the IP address of the sensor you wish to connect to beforehand or will connect to a sensor via a router, select the **Specify the IP address.** check box and then enter the IP address in **IP address**. After input is complete, click the **OK** button.



Precautions for Correct Use

If there is already a different FH/FHV slave device in the project with an established online connection, you will not be able to select the **Search for sensors** option.

3-3 Establishing an Online Connection with a Vision Sensor

Connect with FH/FHV vision sensor on the network.

3-3-1 Establishing an Online Connection from the Sensor Connection Screen

You can open the sensor connection screen in the Edit Pane by double-clicking the type name of the FH/FHV vision sensor in the Multiview Explorer or by right-clicking it and selecting **Edit** from the menu.

<Multiview Explorer>

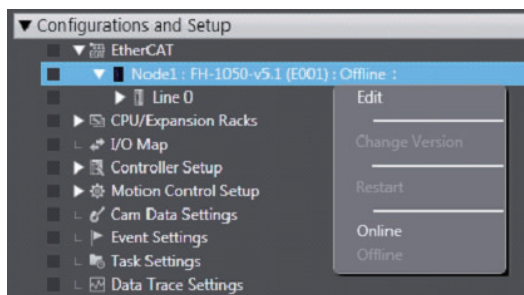

<Sensor connection screen>

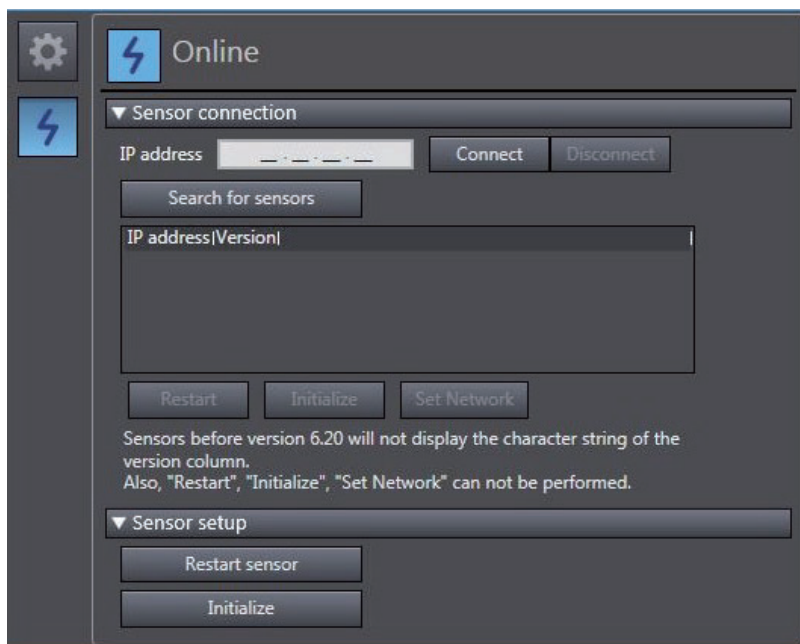

Click the **Search for sensors** button of **Online - Sensor connection** to display a list of the IP addresses of the FH/FHV vision sensors on the same network. Select the FH/FHV vision sensor you wish to connect to and then click the **Connect** button.

You can also directly enter an IP address in the IP address field.

If you wish to connect with an FH/FHV vision sensor via a router, directly enter the IP address and then click the **Connect** button.

3-3-2 Establishing an Online Connection from the Multiview Explorer

If the FH/FHV vision sensor to be connected has already been set, you can establish an online connection with it by right-clicking the type name of the FH/FHV vision sensor in the Multiview Explorer and then selecting **Online**.

For details on setting the FH/FHV vision sensor to be connected, refer to 3-3-1 *Establishing an Online Connection from the Sensor Connection Screen* on page 3-4.

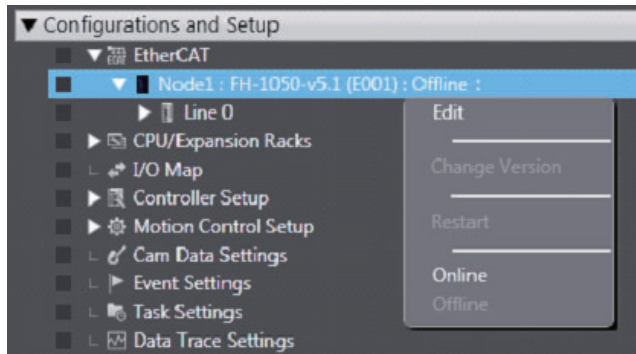

If the FH/FHV vision sensor that has already been set cannot be found, the automatically detected FH/FHV vision sensors are displayed in a list. Select the FH/FHV vision sensor you wish to connect to.

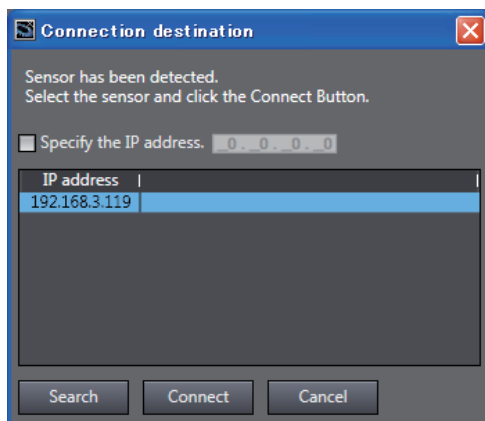

Precautions for Correct Use

- When you connect vision sensors to Sysmac Studio by the network, set the same network addresses for all the vision sensors and computer where Sysmac Studio is running.
Example:
When the Ethernet settings set for the vision sensors are as follows, the network addresses of the vision sensors and the computer are "10.5.5.*".
IP address: 10.5.5.100
Subnet mask: 255.255.255.0
- If you plan to control the vision sensor from Sysmac Studio over the network, you will need to have the Remote Operation option for the Communication module for the FH/FHV sensor set to ON (initial setting).
For details on how to configure the settings, refer to *Vision System FH/FHV Series User's Manual (Cat. No. Z365)*.

When connecting an FH/FHV sensor whose version does not match the version registered in the project, the following dialog appears.

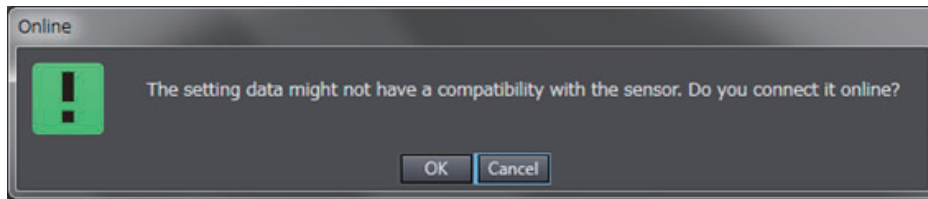

However, when there is combination of connections whose version is not supported, the following dialog appears.

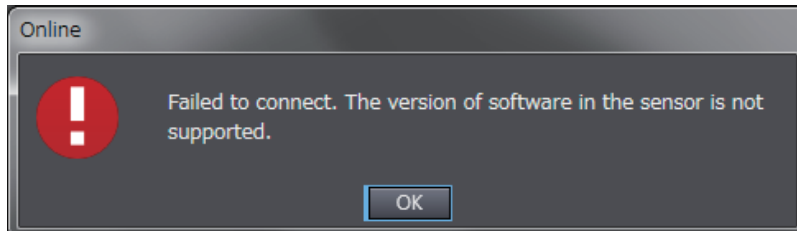

If the versions do not match, online editing cannot properly be performed and editing the data offline cannot be performed after editing it online in some cases. Make sure to connect an FH/FHV sensor whose version matches.



Precautions for Correct Use

When opening a project that contains settings for FH/FHV Sensor whose version is not supported or does not match the registered version, the following dialog appears.

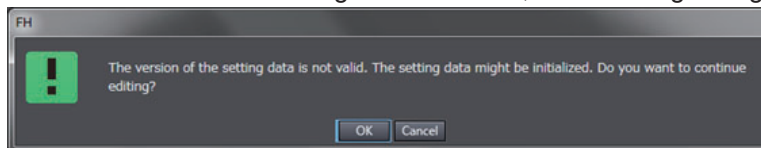

3-4 Synchronizing Project Data and Sensor Setting Data

3-4-1 Transferring Project Data to the Sensor

Project data and setting data for the FH/FHV vision sensor can be synchronized together.

- 1 Establish an online connection for the vision sensor.
Establish an online connection for the FH/FHV vision sensor that you wish to synchronize to the project data.
For details, refer to *3-3 Establishing an Online Connection with a Vision Sensor* on page 3-4.

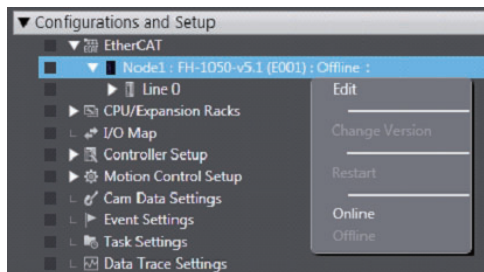

- 2 Select the data that you wish to have transferred.
The **Data transfer** window will appear once you are online.

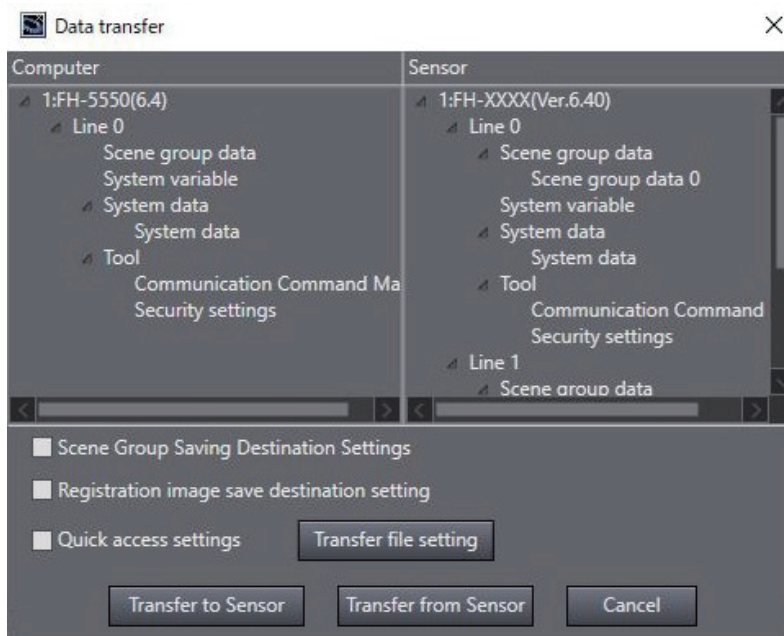



Precautions for Correct Use

- When you check the **Scene Group Saving Destination Settings** and transfer processing is executed as **Transfer to Sensor**, the scene group saving destination data saved in the project will be transferred. If the saving destination specified in the transferred Scene group saving destination data does not exist, the saving destination setting will be cleared.
- When you check the **Registration image save destination setting** and transfer processing is executed as **Transfer to Sensor**, the registration image save destination setting saved in the project will be transferred.
An image being managed by the Registered Image Manager Tool will not be transferred.
- When you check the **Quick access settings** and transfer processing is executed as **Transfer to Sensor**, the quick access settings saved in the project will be transferred. The settings to be transferred can be selected by checking the **Transfer data** in the **Transfer file setting**.

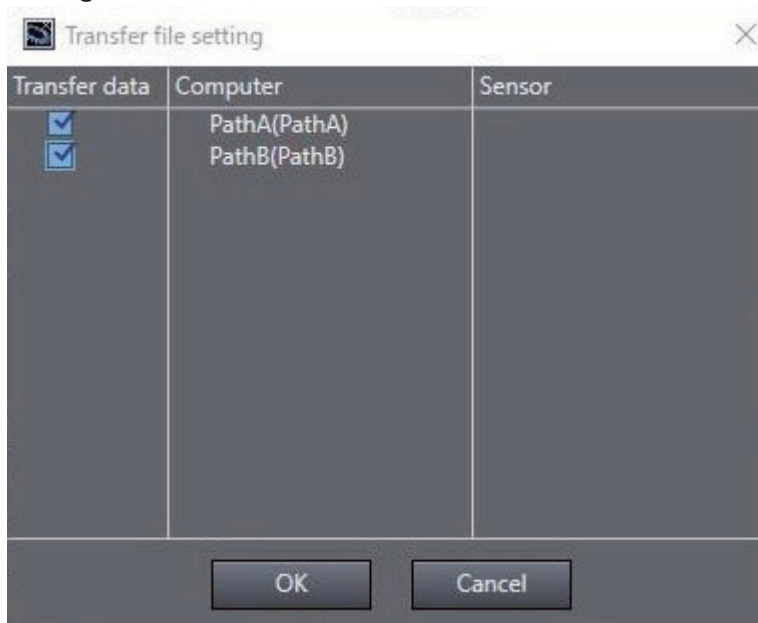

3 Initiate the data transfer.

To transfer the project data to the FH/FHV vision sensor, select **Transfer to Sensor**. Choose **Yes** when the below message appears to begin the transfer.

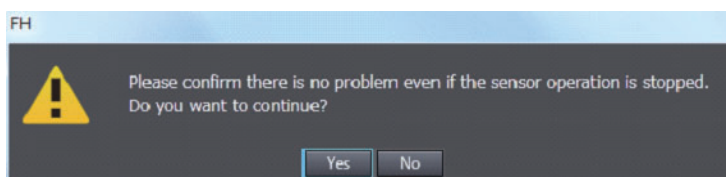

Once the transfer is finished, restart the FH/FHV vision sensor. Click **OK**.

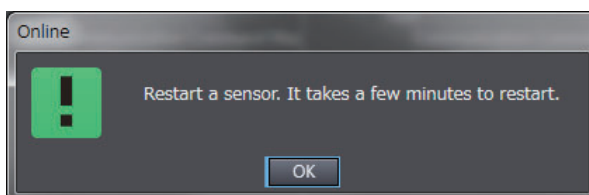



Precautions for Correct Use

To transfer settings data with large file sizes, you will need to use a compatible external memory device that can be inserted into the FH/FHV vision sensor.

If the below message appears to indicate that the file size is too large for a normal transfer, insert a compatible memory device with enough free space to proceed.

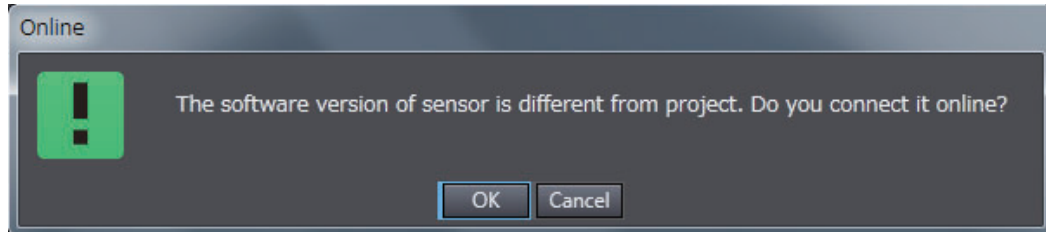

3-4-2 Transferring Setting data in the Sensor to a Project

3

- 1 Establish an online connection for the vision sensor.
Establish an online connection for the FH/FHV vision sensor that you wish to transfer its data to the project.
For details, refer to 3-3 *Establishing an Online Connection with a Vision Sensor* on page 3-4.

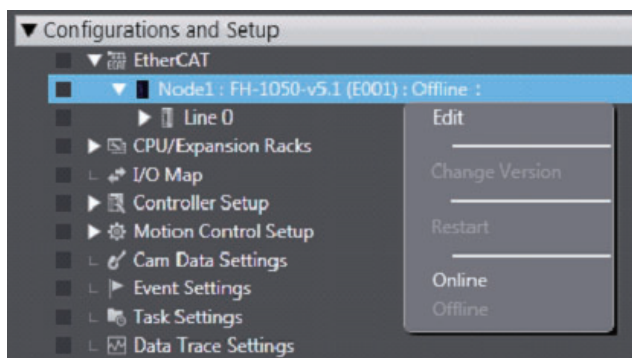

- 2 Switch to offline.
After establishing an online connection, switch the FH/FHV vision sensor to offline.
- 3 Select the data that you want to transfer.
The **Data transfer** window is displayed.
Select the check box of the data that you want to transfer.

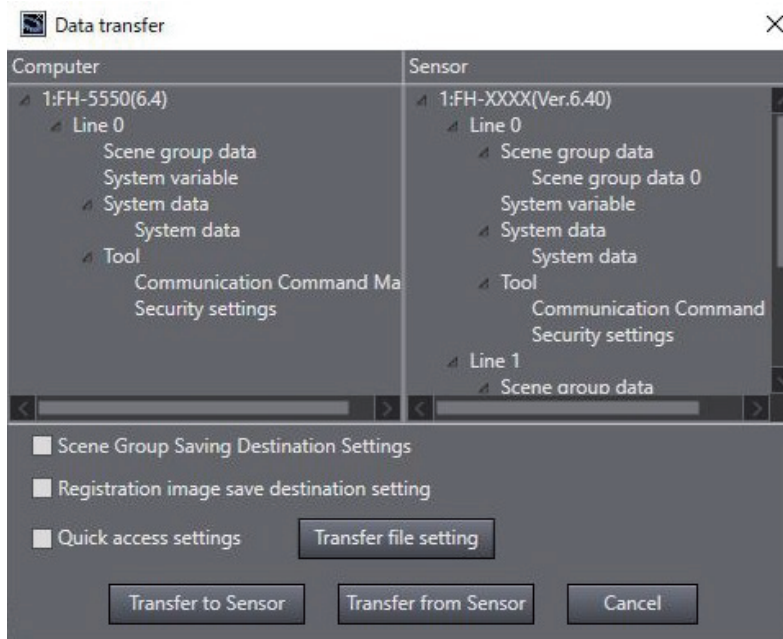

4 Initiate the data transfer.

To transfer the setting data in FH/FHV vision sensor to the project, select **Transfer to computer**.

Choose **Yes** when the below message appears to begin the transfer.

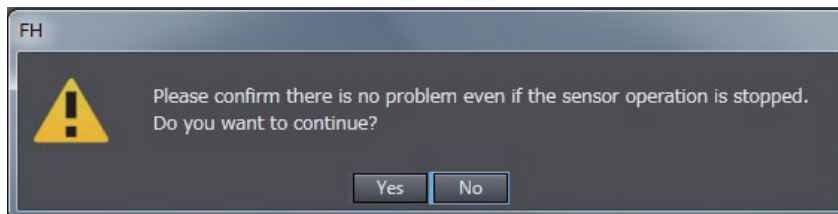

Precautions for Correct Use

To transfer settings data with large file sizes, you will need to use a compatible external memory device that can be inserted into the FH/FHV vision sensor.

If the below message appears to indicate that the file size is too large for a normal transfer, insert a compatible memory device with enough free space to proceed.

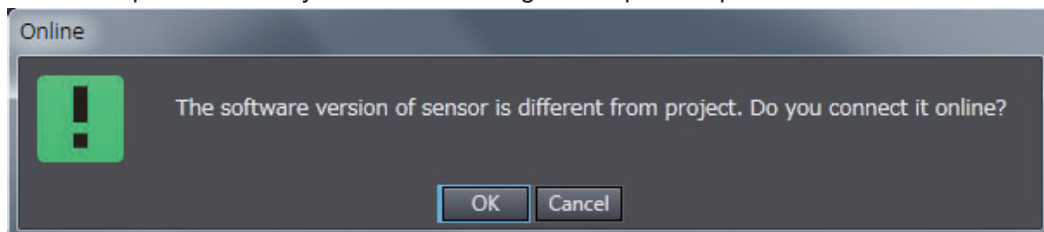

3-5 Ending a Connection with a Vision Sensor

End the connection with a sensor currently connected with an online connection and switch to the offline state.



Additional Information

You can also check and edit settings data while the sensor is offline.

3-5-1 Ending a Connection in the Sensor Connection Screen

Open the sensor connection screen and then click the **Disconnect** button of **Online - Sensor connection**.

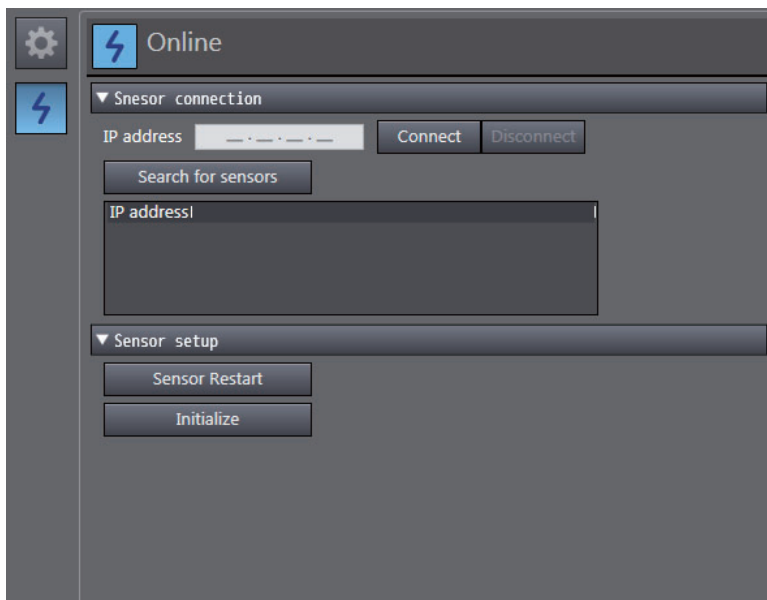

3-5-2 Ending a Connection in the Multiview Explorer

Right-click the type name in the Multiview Explorer and select **Offline** from the menu.

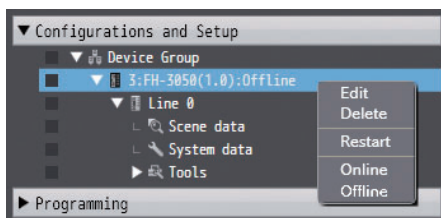

3-6 Logging in to a Registered User's Account

If you have an account registered for an FH/FHV vision sensor, you will need to log in to the registered user account whenever you establish an online account with the relevant FH/FHV vision sensor. Log in using the user account for the UG0 group.

- 1** Establish an online connection with a vision sensor.
Establish an online connection with an FH/FHV vision sensor.
For details, refer to *3-3 Establishing an Online Connection with a Vision Sensor* on page 3-4.
- 2** Log in to your account.
If you have a user account registered for an FH/FHV vision sensor that is online, the below log-in screen will appear. Enter the user account for the registered account for the UG0 group and then select **OK**.

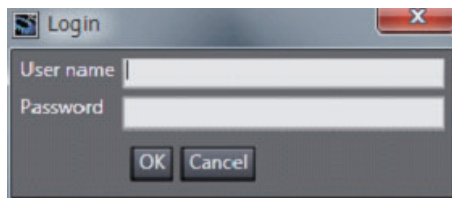

Precautions for Correct Use

This function becomes available when the user name of the account for the FH/FHV vision sensor is changed from default settings.

The default **User name** and **Password** are both *Administrator*.

4

Configuring Measurement Settings

On the FH.FHV vision sensor, processing items can be combined to configure measurement details. This section provides an overview of the processing units and describes how to edit a processing unit.

4

4-1	Overview of Processing Units	4-2
4-1-1	Input Image	4-2
4-1-2	Measurement	4-2
4-1-3	Compensate Image	4-2
4-1-4	Support Measurement	4-3
4-1-5	Branch	4-3
4-1-6	Output Result	4-3
4-1-7	Display Result	4-3
4-2	Editing a Processing Unit.....	4-5
4-2-1	Parameter Settings	4-5
4-2-2	Editing an Area	4-7
4-2-3	Color Extraction	4-10
4-2-4	Color	4-11
4-2-5	Binary.....	4-11
4-2-6	Detection Point/Reference Point.....	4-11
4-2-7	List	4-12
4-2-8	Image Control Area.....	4-12

4-1 Overview of Processing Units

This section provides an overview of the processing units that can be edited in the FH/FHV tools. For details on each of the processing units, refer to *Vision System FH/FHV Series Processing Item Function Reference Manual (Cat. No. Z341)*.

4-1-1 Input Image

This is a processing unit for loading images from a camera. The main setting items are as follows.

Group	Item
Camera setting	Sets the camera shooting conditions.
Screen adjust	Sets the conditions related to the lighting and lens.
White balance	Sets the white balance in images loaded from the camera to correct its color and to make the white parts appear as white.
Calibration	Configures the settings for converting measurement results to the actual dimensions.
HDR setting	Sets the method for combining images in order to obtain it with a wide dynamic range.
Bright adjust setting	Sets how much the brightness of loaded images to be adjusted.

4-1-2 Measurement

This is a processing unit for inspection and measurement. The main setting items are as follows.

Group	Item
Model	Allows you to register the parts you wish to inspect as models.
Region setting	Sets the range for searching a model and the range for calculating the amount of a certain feature.
Detection point	Sets which parts of a model you wish to detect as the coordinates during measurement.
Ref. setting	Changes the measurement values that will be the reference registered during model registration and region setting.
Measurement condition	Sets the condition for performing measurement.
Judgment condition	Sets the judgment condition for measurement values.
Output conditions	Sets the reflection condition for the coordinates or overall judgment output as measurement results.
Color	Sets the color information used for measurement.

4-1-3 Compensate Image

This is a processing unit for correcting images. The main setting items are as follows.

Group	Item
Filter setting	Sets the filter conditions for image correction.

Group	Item
Region setting	Sets the region for performing correction.
Output image	Selects the image to output.

4-1-4 Support Measurement

This is a processing unit for providing support for calculation processing, data acquisition and browsing, and other processing.

The main setting items are as follows.

Group	Item
Setting*1	Sets the condition for performing measurement.
Judgment condition	Sets the judgment condition for measurement values.
Output conditions	Sets the reflection condition for the coordinates or overall judgment output as measurement results.

*1. The item names differ for each processing unit.



Precautions for Correct Use

The decimal point symbol in the editing screen for Unit macros and Unit calculation macro processing items is fixed at "." (period), regardless of your computer's OS settings.

4-1-5 Branch

This is the processing unit for performing branching processing.

The main setting items are as follows.

Group	Item
Branch setting	Sets the condition for performing branching.
Setting	Sets the communication function and timeout function for performing flow control by communication.
Output conditions	Sets the reflection condition for the overall judgment.

4-1-6 Output Result

This is the processing unit for outputting measurement results to an external device.

The main setting items are as follows.

Group	Item
Setting	Sets the content to output.
Output format	Sets the format of the data to output.
Output conditions	Sets the reflection condition for the overall judgment.

4-1-7 Display Result

This is the processing unit for displaying any text, figure, or image on the screen displaying the measurement results.

The main setting items are as follows.

Group	Item
Setting ^{*1}	Sets the content or condition to display.
Output conditions	Sets the reflection condition for the overall judgment.

*1. The item names differ for each processing unit.

4-2 Editing a Processing Unit

Right-click any processing unit in the flow list and then select **Edit** from the menu. The editing screen of the selected processing unit appears.

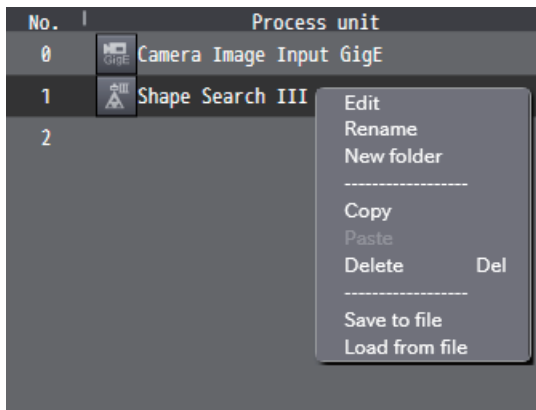

The editing screens of processing units are categorized into the following two types.

<Editing Screen with Image Display>

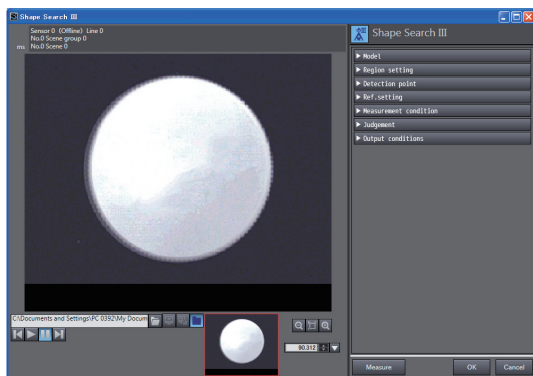

<Editing Screen without Image Display>

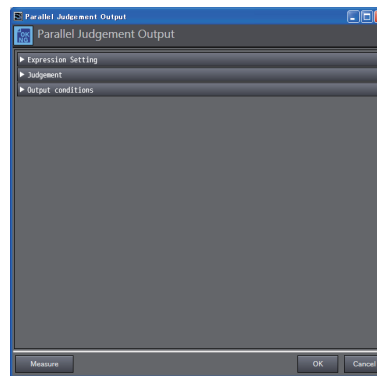







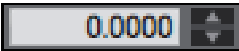

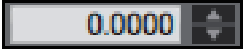
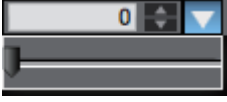

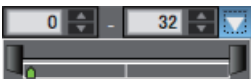

Each setting menu can be opened and closed on a group basis. In an editing screen with image display, an image or graphic information is displayed in accordance with the open menu. Clicking the **OK** button confirms the changes and closes the editing screen of the processing unit. Clicking the **Cancel** button discards the changes and closes the editing screen of the processing unit. The basic editing operations that can be performed with this tool are described below.

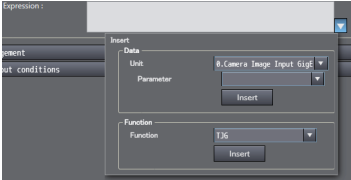
4-2-1 Parameter Settings

The following table lists the basic user interface components used for editing parameters.

UI	Item	Description
	Numerical value input area	Allows you to enter numerical data. Entered data is treated as a double type value, but is displayed up to 4 digits after the decimal point.

UI	Item	Description
<p>Before clicking:</p>  <p>After clicking:</p> 	Numerical value input area (With slider)	Allows you to enter numerical data. Entered data is treated as a double type value, but is displayed up to 4 digits after the decimal point. Clicking the button beside the numerical value input box displays a slider. Parameter values can be adjusted with the slider.
<p>Before clicking:</p>  <p>After clicking:</p> 	Numerical value upper limit and lower limit input area (With slider)	Allows you to enter numerical data for the upper and lower limits. Entered data is treated as a double type value, but is displayed up to 4 digits after the decimal point. Clicking the button beside the numerical value input box displays a slider. Parameter values can be adjusted with the slider. It is not possible to set a lower limit value that is greater than the upper limit value.
<p>Before clicking:</p>  <p>After clicking:</p> 	Numerical value upper limit and lower limit input area (With slider) (With measurement value display)	This is the numerical value upper limit and lower limit input area with the addition of measurement value display. The bar at the place of the measurement value of the slider is green when the value is OK and red when it is NG.
<p>Before clicking:</p>  <p>After clicking:</p> 	Expression	Allows you to enter an expression. When input is complete, a validity check is performed for the expression. Clicking the button beside the text input box displays the calculation parameter input area. Any parameter can be inserted. Note: When entering a calculation formula, the decimal point symbol is fixed at "." (period), regardless of your computer's OS settings.
	Text input area	Allows you to enter any text. The following characters cannot be entered. <ul style="list-style-type: none"> • ! • Tab
<p>Unselected:</p>  <p>Selected:</p> 	Radio button	Selects one item from multiple selection items.
<p>Unchecked:</p>  <p>Checked:</p> 	Check box	Enables or disable an item.

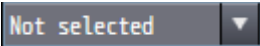
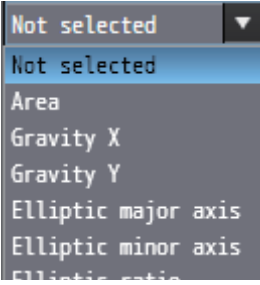
UI	Item	Description
Before clicking:  After clicking: 	Combo box	Selects one item from multiple selection items.

4-2-2 Editing an Area

You can edit a model area or measurement area.
 Click the area editing button to display the area editing menu.

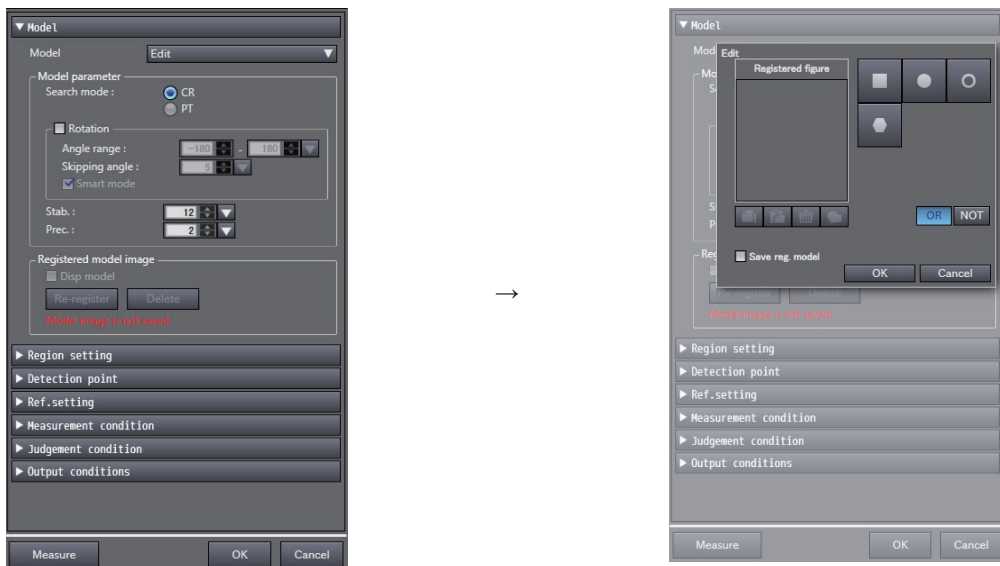

Six area editing functions are provided.

Rectangle

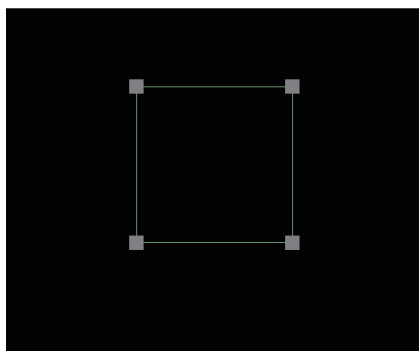

This function draws a rectangle. You can change the size of the rectangle by dragging the four corners.

The rectangle can be moved by clicking and then dragging the inside of the rectangle.

Wide line

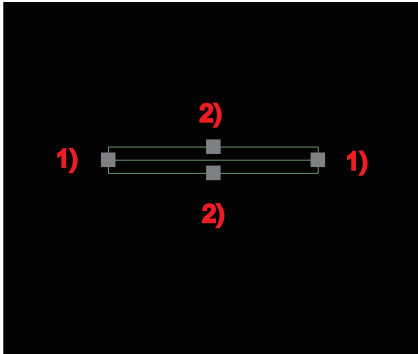

This function draws a wide line.

You can change the size or direction by dragging the following vertices.

- Vertex (1)
You can change the length or direction of the line by changing the start point or end point.
- Vertex (2)
These allow you to change the width of the line.

The line can be moved by clicking and then dragging the inside of the area.

Ellipse

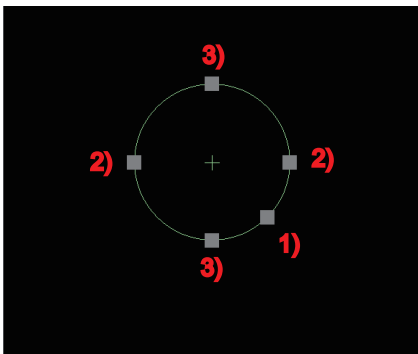

This function draws a circle or ellipse.

You can change the size by dragging the following vertices.

- Vertex (1)
These allow you to change the overall size while maintaining the XY ratio.
- Vertex (2)
These allow you to change the size in the X direction.
- Vertex (3)
These allow you to change the size in the Y direction.

The line can be moved by clicking and then dragging the inside of the area.

Circumference

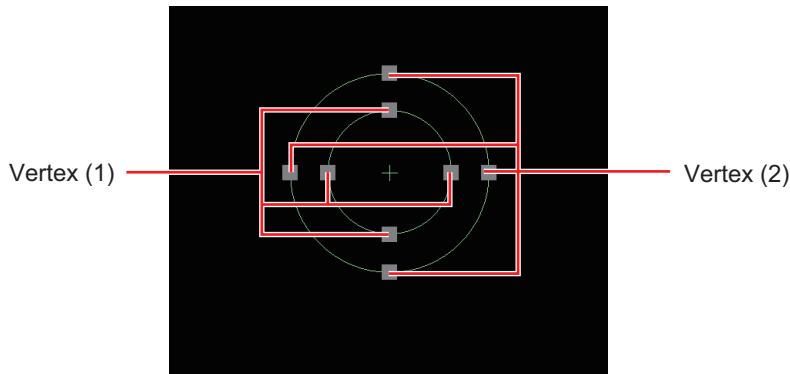

This function draws a circumference.

You can change the size by dragging the following vertices.

- Vertex (1)
These change the radius of the inner circle.
- Vertex (2)
These change the size of the circle while maintaining the difference in the diameters of the inner and outer circles.

The line can be moved by clicking and then dragging the inside of the area.

Wide arc

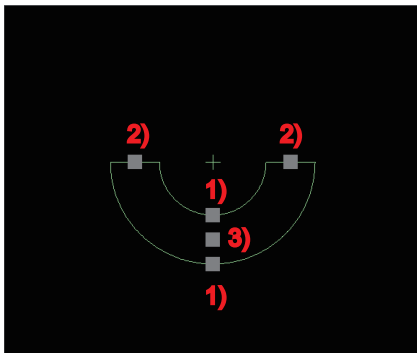

This function draws a wide arc.

You can change the start point, end point, width, and position by dragging the following vertices.

- Vertex (1)
These allow you to change the width.
- Vertex (2)
These allow you to change the start point, end point, and radius.
- Vertex (3)
This allows you to move the center position while keeping the start point and end point positions fixed.

The line can be moved by clicking and then dragging the inside of the area.

Polygon

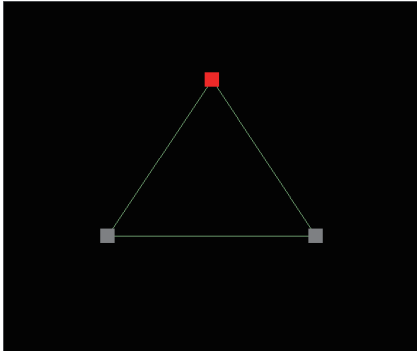

This function draws a polygon.

Up to 10 vertices can be added.

Clicking any position on a side creates a new vertex.

You can change the position of a vertex by dragging it.

The line can be moved by clicking and then dragging the inside of the area.

4-2-3 Color Extraction

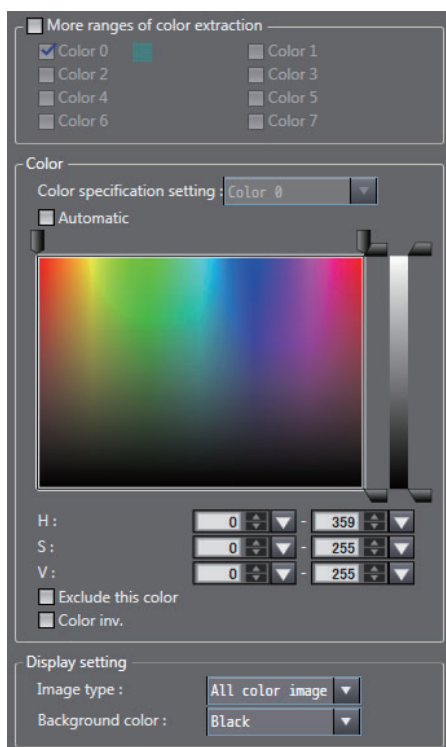

You can specify up to eight colors.

Also, when the **Automatic** check box is selected, enclosing any part in a displayed image automatically extracts the color of that part.

The color range can be specified by specifying the hue, saturation, and brightness.

The specifications are the same as for the user interface of the FH/FHV vision sensor.

For details, refer to *Vision System FH/FHV Series Processing Item Function Reference Manual (Cat. No. Z341)*.

4-2-4 Color

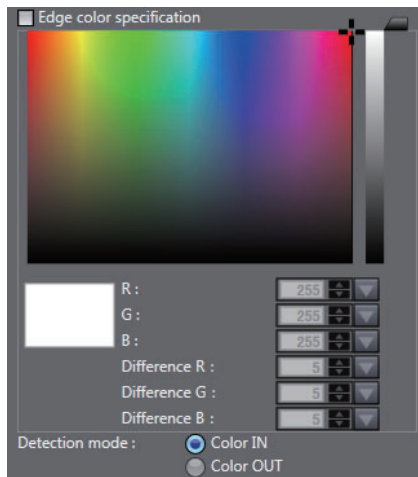

You can specify any color.

The color range can be specified by specifying the hue, saturation, and brightness.

The specifications are the same as for the user interface of the FH/FHV vision sensor.

For details, refer to *Vision System FH/FHV Series Processing Item Function Reference Manual (Cat. No. Z341)*.

4-2-5 Binary

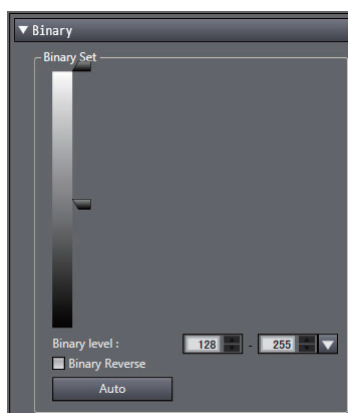

You can specify the range of binarization levels.

If you select the **Binary Reverse** check box, binarization is performed for outside of the range between the upper and lower limits.

4-2-6 Detection Point/Reference Point

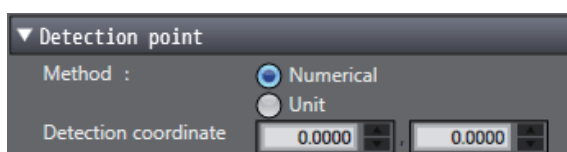

The detection point and reference point can be set with the numerical value input boxes.

Clicking any place in the displayed image reflects that coordinate value as the setting value.

4-2-7 List

No.	Comment	Result	Expression
0			
1			
2			
3			
4			
5			
6			
7			

No.0

Comment :

Result : 0.0000

Expression :

Selecting an item in the list displays the information for the selected item below the list. Each of the information items displayed below the list can be edited.

4-2-8 Image Control Area

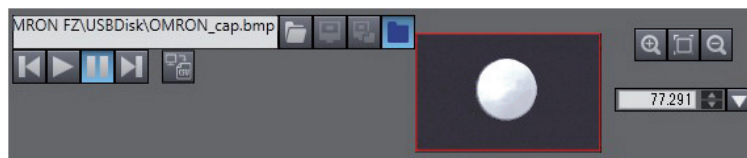

File selection section

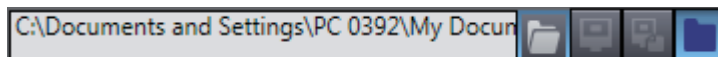

This allows you to select the image to display. Refer to *File selection section* on page 2-21.

Image control section





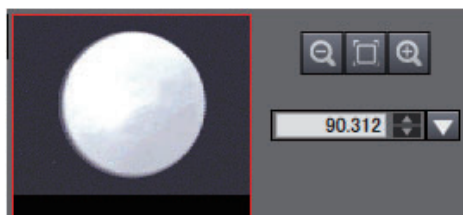

This allows you to control the measurement of the image. Refer to *Image control section* on page 2-21.

Image size control section



This allows you to enlarge or reduce the displayed image. The place where the image is displayed in the left zoom area is enclosed in a rectangle. You can move the display place by moving this rectangle.

Button	Description
	Enlarges the image. Doubles the size of displayed image. (Upper limit: 1600%)
	Reduces the image. Halves the size of displayed Image. (Lower limit: 1%)
	Makes the image to fit the display frame.
	The zoom ratio can be specified by directly entering a numerical value or by moving the slider.

5

Designing Exchange with External Devices

This section describes how to establish a connection with an external device.

5-1	Designing Exchange with External Devices	5-2
5-2	Setting Procedure	5-3

5-1 Designing Exchange with External Devices

The FH/FHV vision sensor has the following interfaces.

- Parallel I/O
- RS-232C/422
- Ethernet
- EtherCAT
- PROFINET

Each interface supports various communication protocols.

You can configure their communication settings in the system settings of the FH/FHV tools.

Configure the communication settings for each line when in the multiple multi-line random-trigger modes. However, some data is settings data that is common to the lines.

Group	Item	Attribute
Parallel I/O		Common to lines
		-
RS-232C/422		Common to lines
		-
Ethernet	Address settings	Common to lines
	Input/output settings	Individual to each line
EtherNet/IP		Individual to each line - Some parameters are common to lines.
EtherCAT		Individual to each line
PROFINET		Individual to each line

If the communication settings are changed, the FH/FHV vision sensor needs to be restarted.

If a parameter that requires a restart is edited, "" is displayed for the sensor type in the Multiview

Explorer. If "" is displayed, save the settings and then restart the FH/FHV vision sensor.

For details on restarting, refer to *2-4-4 Multiview Explorer* on page 2-11.

5-2 Setting Procedure



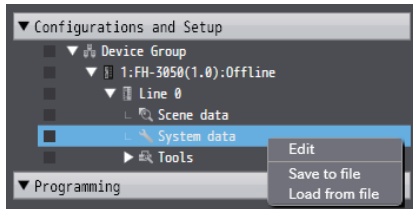



You can open the system settings screen by double-clicking **System data** in the Multiview Explorer or by right-clicking it and selecting **Edit** from the menu.

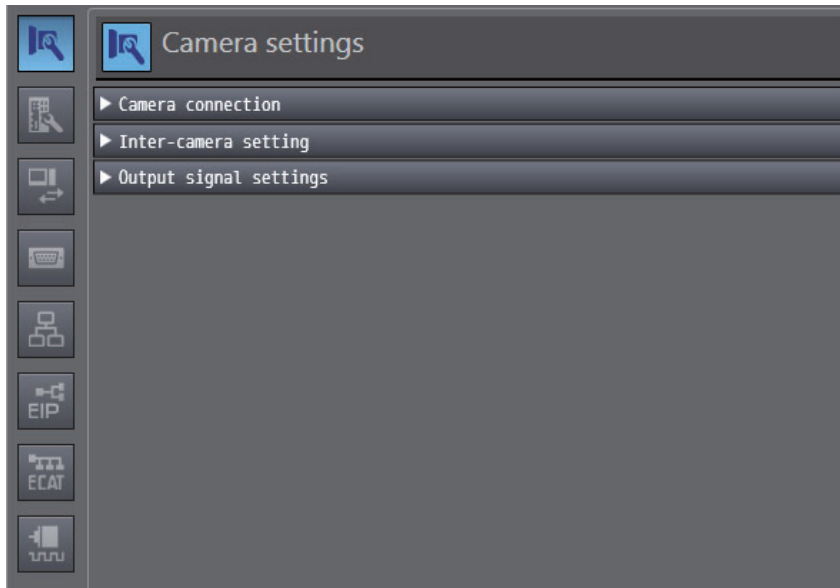

In the system settings screen, you can click any of the following buttons to configure the corresponding settings.

For details, refer to *Vision System FH/FHV Series User's Manual (Cat. No. Z365)*.



Button	Setting Item	Description
	Parallel I/O	Sets the Parallel I/O settings.
	RS-232C/422	Sets the RS-232C/422 settings.
	Ethernet	Sets the settings related to Ethernet.
	EtherNet/IP	Sets the settings related to EtherNet/IP.
	EtherCAT	Sets the settings related to EtherCAT.
	PROFINET	Sets the settings related to PROFINET.



Precautions for Correct Use

- A restart is required after configuring the Ethernet, EtherNet/IP, and EtherCAT settings.
- When multi-line random-trigger mode is selected, the communication settings needs to be configured for each line.

However, the RS-232C/422 settings are common between the lines.

For the other communication settings, individually configure the settings in the system settings for each line.



Online Debugging

This section describes how to perform online debugging of the FH/FHV sensor.

6-1	Performing Test Measurement	6-2
6-1-1	Measuring Camera Images	6-2
6-1-2	Measuring File Images in the RAMDisk or the External Memory, i.e. USB Flash Drive of the Vision Sensor.....	6-3
6-1-3	Measuring Logging Images in the Vision Sensor Memory	6-3
6-2	Checking Measurement Results	6-4
6-2-1	Checking Detailed Results.....	6-4
6-2-2	Changing the Image Display Settings.....	6-5
6-2-3	Checking Multiple Measurement Images at the Same Time	6-6
6-3	Checking Result Output	6-7
6-4	Saving Measurement Results	6-8
6-5	Saving Settings Data	6-9
6-6	Loading Settings Data	6-10

6-1 Performing Test Measurement

You can perform test measurement with the FH/FHV tools.

Select from the following three test measurement target images when connected with an online connection.

Target Image	Measurement Type	Description
Camera image	Single measurement	Measures a camera image.
	Continuous measurement	Continuously measures camera images.
File image	Single measurement	Allows you to select and measure a file image in the RAMDisk or the external memory, i.e. USB flash drive of the FH/FHV vision sensor.
	Continuous measurement	Continuously measures file images in the RAMDisk or external memory, i.e. USB flash drive of the FH/FHV vision sensor. Measurement ends when measurement of the images within the same folder finishes.
Logging image	Single measurement	Allows you to select and measure a logging image in the FH/FHV vision sensor memory.
	Continuous measurement	Continuously measures logging images in the FH/FHV vision sensor memory. Measurement ends when measurement of all logging images finishes.

6-1-1 Measuring Camera Images

To select a camera image, first click the **camera image** button () in the file selection section. Then select a camera image and click the **Measure** button.

Measure is provided in the following editing screens.

- Scene maintenance window
- Scene editing screen
- Processing unit editing screen

<Scene maintenance window>

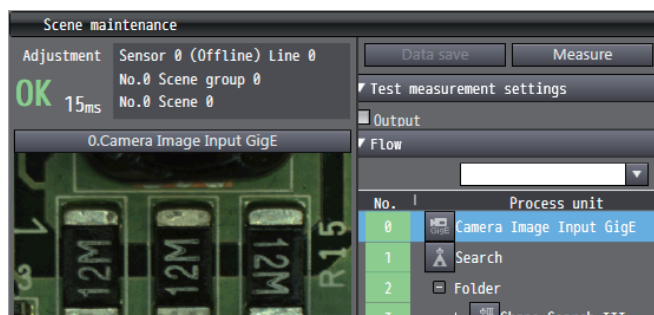

<Scene editing screen>



<Processing unit editing screen>

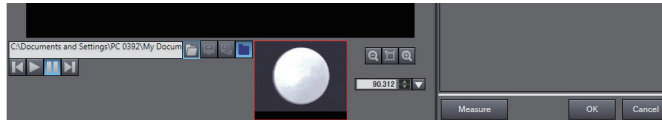

To start continuous measurement, click the continuous measurement button (▶).

If you wish to stop continuous measurement, click the continuous measurement stop button (▮).

The settings data cannot be edited during continuous measurement.

6-1-2 Measuring File Images in the RAMDisk or the External Memory, i.e. USB Flash Drive of the Vision Sensor

Select the measurement target file and click the **Measure** button.

Select the file as described below.

- 1 Click the file button.

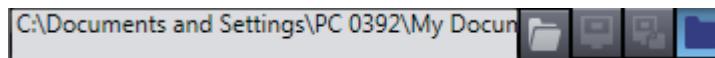

- 2 Click the file selection button (📁) and then select the target file.

- 3 Click the **Measure** button.

To start continuous measurement, click the continuous measurement button (▶).

If you wish to stop continuous measurement, click the continuous measurement stop button (▮).

The settings data cannot be edited during continuous measurement.

6-1-3 Measuring Logging Images in the Vision Sensor Memory

Select the measurement target logging image and click the **Measure** button.

Select the file as described below.

- 1 Click the Logging image button.

- 2 Click the **Measure** button.

If you wish to change the measurement target logging image, click the button for measuring the previous image (◀) or click the button for measuring the next image (▶).

To start continuous measurement, click the continuous measurement button (▶).

If you wish to stop continuous measurement, click the continuous measurement stop button (▮).

The settings data cannot be edited during continuous measurement.

6-2 Checking Measurement Results

You can check the measurement results in each editing screen.

On the displayed image, the measurement results of the selected processing unit are displayed as a graphic.

6-2-1 Checking Detailed Results

Scene maintenance window, monitor window, and scene data editing screen

Open the **Flow** item and **Detail result** item and click the **Measure** button.

If you select any of the processing units in the list of the **Flow** item, the measurement result of each item that is a judgment result of that processing unit will be displayed in the **Detail result** item.

<Scene maintenance screen>



<Monitor window>



<Scene data editing screen>

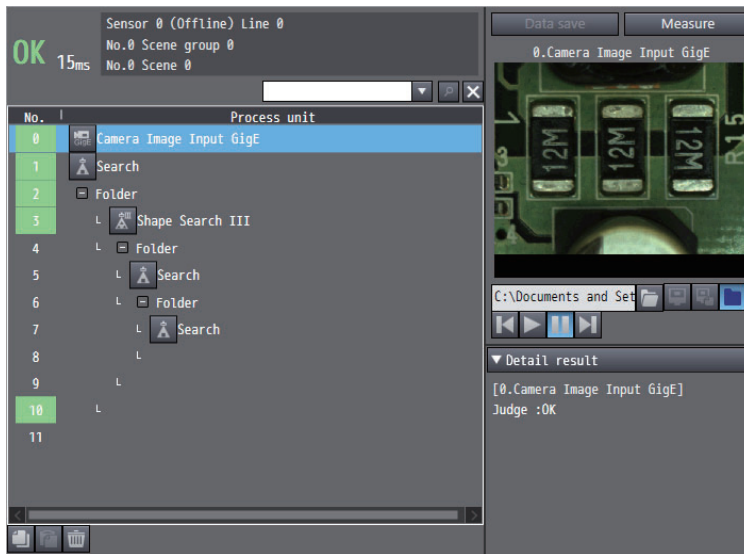

Processing unit editing screen

Open the **Judgment condition** item and click the **Measure** button.

The measurement result of each item that is a judgment result of the processing unit is displayed

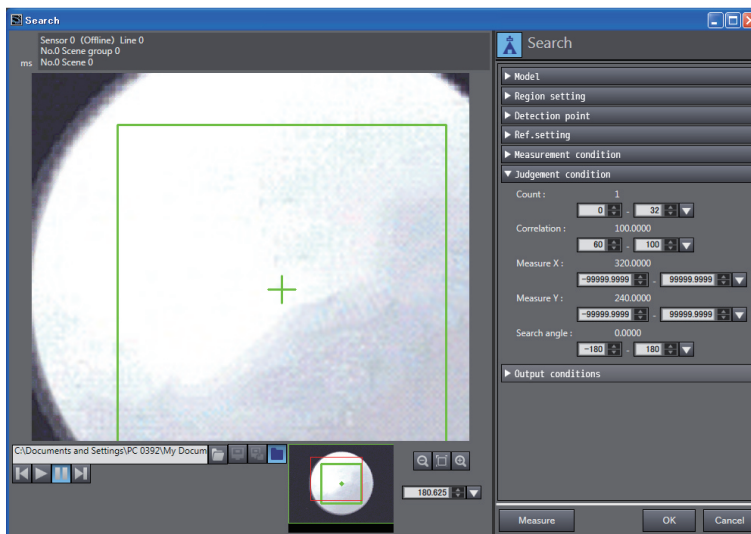

6-2-2 Changing the Image Display Settings

You can change the setting for displaying images in the scene maintenance window and monitor window.

Open the **Image display settings** item and change each items.

For details on the image display settings, refer to *Image display settings* on page 2-19.

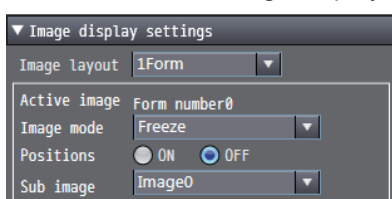

Item	Description
Image layout	Selects the number of images to display. Selection items: 1Form, 2Form, and 4Form
Image mode	Selects the image mode for the image with the focus on it. Selection items: Through, Freeze, and NG image
Positions	Selects position list display for the image with the focus on it. Selection items: OFF and ON
Sub image	Selects the sub image number for the image with the focus on it. Available sub-image numbers vary depending on the processing item. Select items: Image0, Image1,..., image31

You can switch the result display content of the processing unit by changing the sub image number. For details, refer to the content of each processing unit in *Vision System FH/FHV Series Processing Item Function Reference Manual (Cat. No. Z341)*.

6-2-3 Checking Multiple Measurement Images at the Same Time

You can display multiple images by opening the **Image display settings** item and changing **Image layout**.

For details on the image display settings, refer to *Image display settings* on page 2-19.

<2Form display>

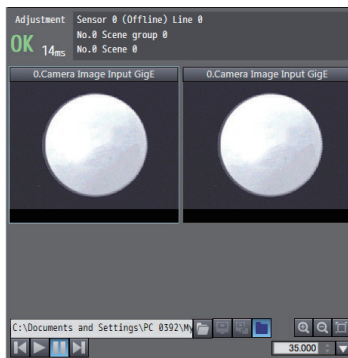

<4Form display>

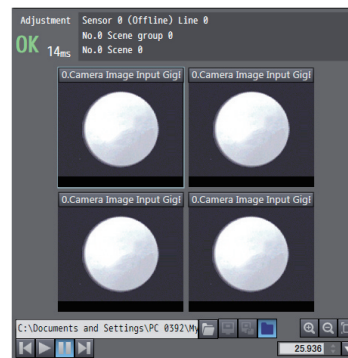

6-3 Checking Result Output

Normally, output to an external device is performed when the monitor window is open, but it is not performed while scene data is being edited in the following editing screens.

- Scene maintenance window
- Scene data editing screen
- Processing unit editing screen
- Editing screen of each tool

If you wish to output the measurement results in those screens, select the following check box in the adjustment screen.

- **Test measurement settings - Output**

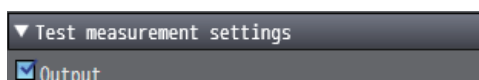

6-4 Saving Measurement Results

If you wish to save measurement results or images, use the logging related processing units.

- Image logging
- Image conversion logging
- Data logging
- Result Output (Message)

Using these processing units, allow to output the measurement results to the FH/FHV vision sensor or the external memory, i.e. USB flash drive.

For details on the processing units, refer to *Vision System FH/FHV Series Processing Item Function Reference Manual (Cat. No. Z341)*.

To acquire the files output to the RAMDisk or the external memory, i.e. USB flash drive of the FH/FHV vision sensor, use the file management tool.

For details, refer to *8-3 Using the File Save Tool* on page 8-5.

6-5 Saving Settings Data

After adjusting the settings data, you need to save the settings data to the flash memory of the FH/FHV vision sensor. There are the following two ways to save the settings data.

1. Right-click **Configuration and Setup - Device Group - FH/FHV-XXXX - Line X** in the Multiview Explorer and then click **Save data**.

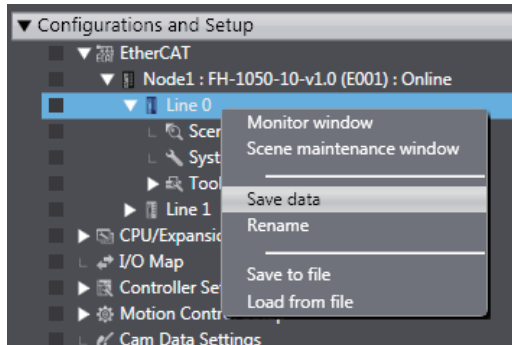

2. Click the **Data save** button in the scene maintenance window.

The settings data can also be saved and managed as files.

- Scene data basis (Refer to 2-5-2 *Managing Scenes* on page 2-33.)
- Scene group basis (Refer to 2-5-6 *Managing Scene Groups* on page 2-34.)
- Processing unit basis (Refer to 2-6-2 *Managing Processing Units* on page 2-37.)

6-6 Loading Settings Data

Loading settings data from file.

1. Right-click **Configuration and Setup - Device Group - FH/FHV-XXXX - Line X** in the Multiview Explorer and then click **Load from file**.

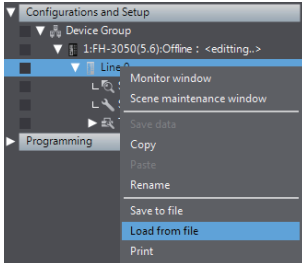

2. From FileExplorer select the System + Scene group data 0 to load from and then click the **Open** button.

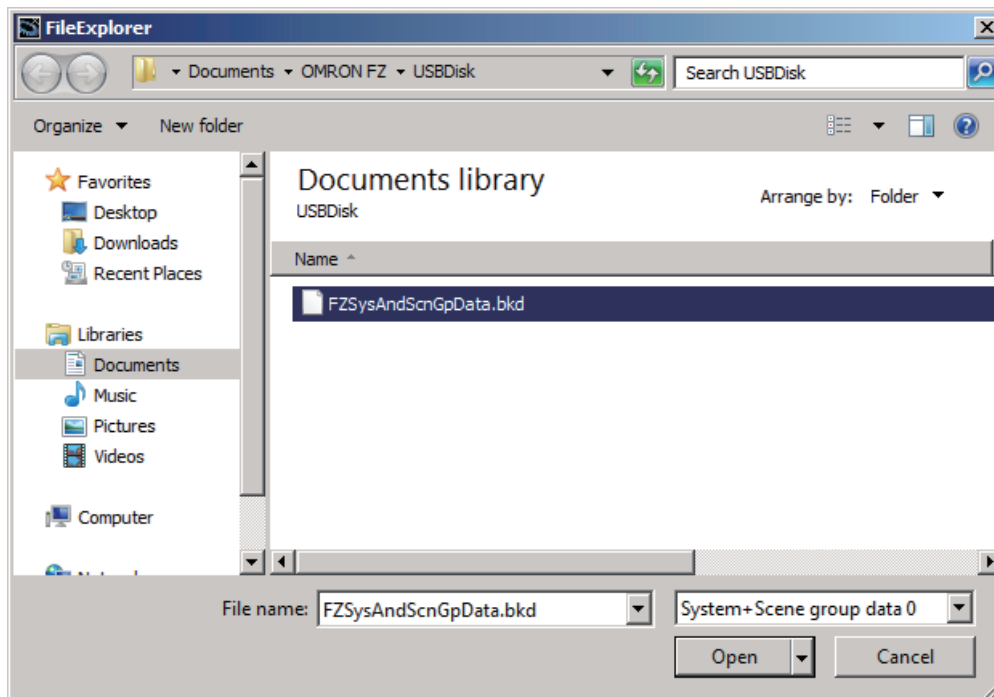



Offline Debugging

This section describes offline debugging techniques for the FH/FHV sensor.

7-1	Performing Offline Simulation of Sensor Measurement Operation.....	7-2
7-2	Offline Debugging of the Sensor Control Program and Sensor Operation (Only When Using EtherCAT Connection)	7-3
7-2-1	Control Signals Supported with Offline Debugging.....	7-3
7-2-2	Offline Debugging Procedure for the Sensor Control Program	7-4

7-1 Performing Offline Simulation of Sensor Measurement Operation

Even when offline, simulation of the measurement operation can be performed using file images on the computer.

Selection and measurement of file image can be performed in the following editing screens.

- Scene maintenance window
- Scene editing screen
- Processing unit editing screen

Select the file as described below.

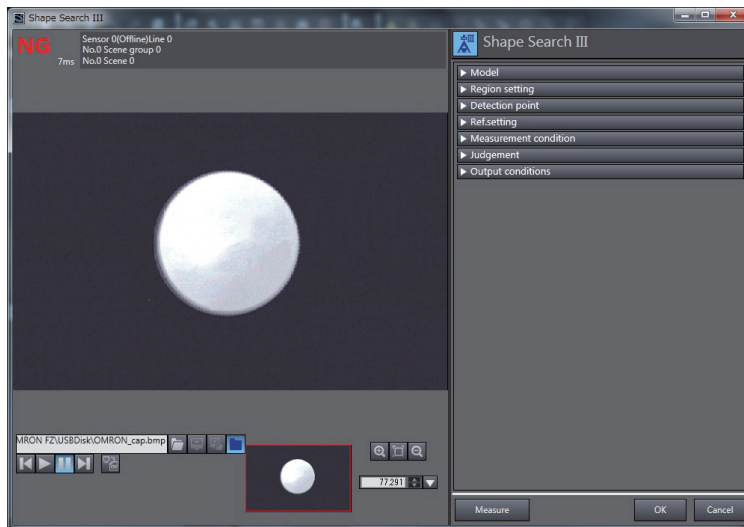

- 1 Click the [File] button.

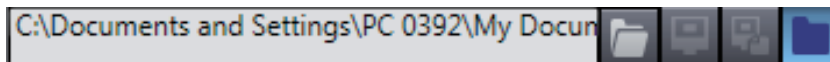

- 2 Click the file selection button (📁) and then select the target file.
- 3 Click the **Measure** button.

If you click the continuous measurement button (▶), continuous measurement of the images in the same folder is performed.

Measurement ends when measurement of all the files finishes.

If you wish to stop continuous measurement part way through the process, click the continuous measurement stop button (⏏).

The **Measure** button is provided in the monitor window, scene maintenance window, and processing unit editing screen.

For details, refer to 6-1-1 *Measuring Camera Images* on page 6-2.



Additional Information

The images measured with the sensor can be saved as logging image files. Refer to 8-3-3 *Saving a Logging Image as a File* on page 8-6.

7-2 Offline Debugging of the Sensor Control Program and Sensor Operation (Only When Using EtherCAT Connection)

In a system built with EtherCAT, you can perform simulation with the sequence control of NJ/NX/NY-series Controller and operation of FH/FHV image sensor linked.

Therefore, offline debugging for operation up until the output of the result is possible for measurement or various other processing performed when a measurement trigger or other control signal is input to the FH/FHV image sensor.

This simulation function is available only in Sysmac Studio (standard edition).



Additional Information

This simulation is supported from the following versions:

- Sysmac Studio (Standard Edition) Ver. 1.08
- FH Software Ver. 5.1

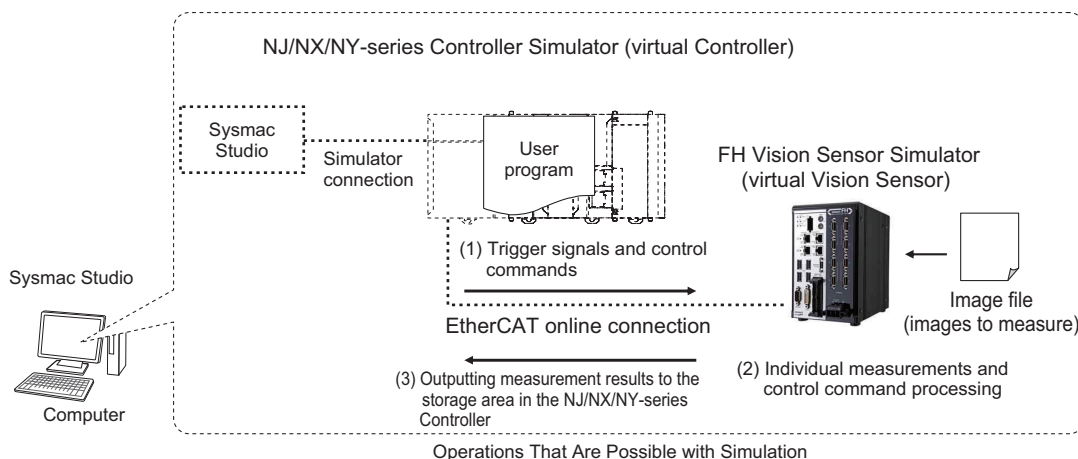

7-2-1 Control Signals Supported with Offline Debugging

The following table shows the operation of each item that is PDO mapped in offline debugging. Logic simulation is possible for this offline debugging. The ON/OFF times of each signal is not the same as the actual processing times.

Item		Signal Input and Output Timing	
Command area	Trigger	Triggers measurement	-
	Command Request	Executes a command	-
	Flow Command Request	Executes a flow command	-
	Result Set Request	Data output request	-
	Error Clear	Clears an error	-

Item			Signal Input and Output Timing
User Area	DINT User Input Area 0 to 3	User Input Area	-
	LREAL User Input Area 4 to 5	User Input Area	-
Response area	Command Completion	Command completed	Turns ON when BUSY signal turns OFF.
	BUSY	Processing in progress	The BUSY ON time is fixed at 10 (PDO cycles).
	Trigger Ready	Trigger input ready state	OFF while BUSY is ON.
	Total Judgement	Outputs total judgment	Outputs when BUSY turns OFF.
	Run Mode	Run mode	Turns ON when monitor window is open.
	Trigger Ack	Trigger acknowledged state	Turns ON one (PDO cycle) after trigger input.
	Command Ready	Ready for command	OFF while BUSY is ON.
	Shutter Output	Outputs shutter trigger	Turns ON for one (PDO cycle) only after trigger input.
	Flow Command Completion	Flow command completed	Turns ON when Flow Command Busy turns OFF.
	Flow Command Busy	Executing flow command	ON time of Flow Command Busy is fixed at one (PDO cycle).
	Flow Command Wait	Ready for flow command	When flow control processing unit is used, turns ON one (PDO cycle) after BUSY turns ON.
	Error Status	Error signal	Turns ON when an error occurs.
	Result Notification	Data output completed	*1
Data area	DINT ResultData 0 to 63	DINT result data	*1
	LREAL ResultData 0 to 31	LREAL result data	*1
User Area	DINT User Output Area 0 to 3	User Output Area	-
	LREAL User Output Area 4 to 5	User Output Area	-

*1. The output timing depends on the operating environment of the computer.

7-2-2 Offline Debugging Procedure for the Sensor Control Program

You can perform simulation with sequence control and image sensor operation linked to perform off-line debugging. The procedure is as follows.

1. Add an image sensor to the EtherCAT slave configuration.
2. Configure the image sensor settings.
Refer to *Section 4 Configuring Measurement Settings* on page 4-1.
3. Input a measurement trigger using a control flag and check the result.

The following describes the procedure from adding an image sensor to the EtherCAT slave configuration to checking the result under the assumption that a sequence program has been prepared.

- 1 Add the FH/FHV-XXXX vision sensor to the EtherCAT slave configuration using either of the methods below.
 - Drag FH/FHV-XXXX from the **Tool box** and drop it on to the network configuration editing window.
 - When the master is selected in the network configuration editing window, double-click FH/FHV-XXXX displayed in the *Tool box*.

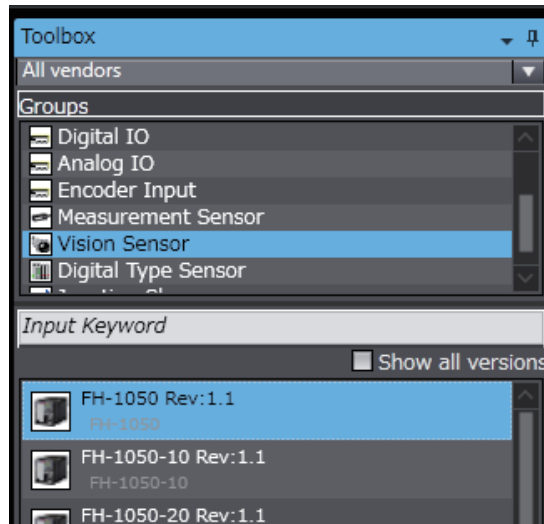

Precautions for Correct Use

- Match the version of the EtherCAT slave to connected FH/FHV sensor version. If you want to choose other than the latest model of FH/FHV sensor, select **Show all versions** and then choose the appropriate ESI file revision.
- When adding FH/FHV sensor in the NJ/NX/NY project, the revision displayed in the tool box is the ESI file revision. The FH/FHV sensor software version that can be selected will differ depending on the ESI file revision.
 - Rev.1.2: FH/FHV Sensor Software Ver. 5.75 (Temp) or later.
 - Rev.1.1: FH Sensor Software Ver. 5.5 to 5.7 (Temp).
 - Rev.1.0: FH Sensor Software Ver. 5.3, or earlier.

For details on how to register to the EtherCAT slave, refer to *EtherCAT Configuration and Settings* in *Sysmac Studio Version 1 Operation Manual (Cat. No. W504)*.

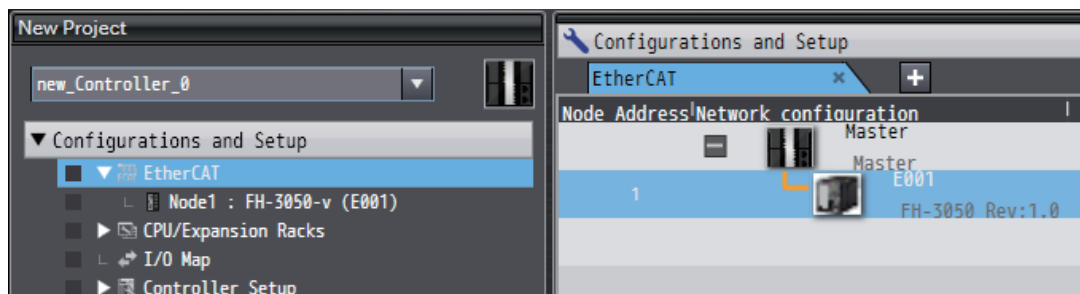

- 2 Configure the vision sensor settings. Double-click **NodeX: FH/FHV-XXXX - Line X - Scene data/System data** in the Multiview Explorer.

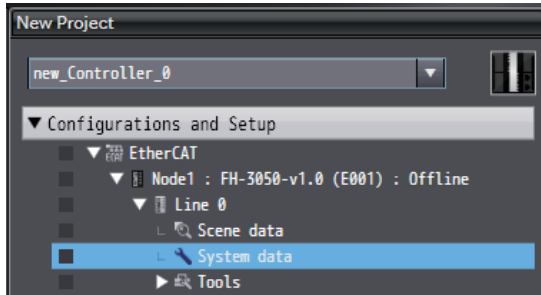

The corresponding data settings screen appears in the Edit Pane. Configure the various settings.

3 Create device variables.

Create device variables to access the FH/FHV.

For details on how to create device variables, refer to *Creating Device Variables in Sysmac Studio Version 1 Operation Manual (Cat. No. W504)*.

4 Create and build a program to operate the device.

For details on how to create a program, refer to *Programming in Sysmac Studio Version 1 Operation Manual (Cat. No. W504)*.

5 Open the scene monitor window.

Right-click **FH/FHV-XXXX - Line X** in the network configuration editing pane and then select **Monitor window**.

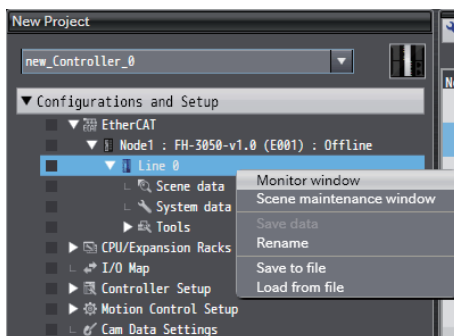

6 Specify the measurement image.

Click the image file selection button and then select an image.

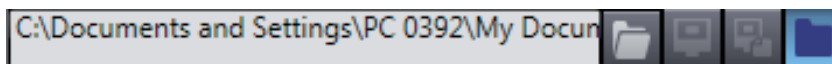

Additional Information

There are no image files immediately after installation of the FH/FHV tool. Acquire logged files or image files saved in the FH/FHV unit. To acquire images, refer to *Saving Logged Images in the Controller Memory (RAM) to a RAM Disk or an External Memory Device in Vision System FH/FHV Series User's Manual (Cat. No. Z365)*.

7 Select **Simulation - RUN**.

The simulator starts.

When the simulator connection is complete, the simulator of the NJ/NX/NY-series Controller and FH/FHV vision sensor internally establish an online connection with EtherCAT and the NJ/NX/NY-series Controller enters the operating state.

For details on how to operate the simulator, refer to *Debugging with Program Simulation* in *Sysmac Studio Version 1 Operation Manual (Cat. No. W504)*

- 8 If you operate the control flag from sequence control and execute measurement, you will be able to check the measurement results in the following monitor window.

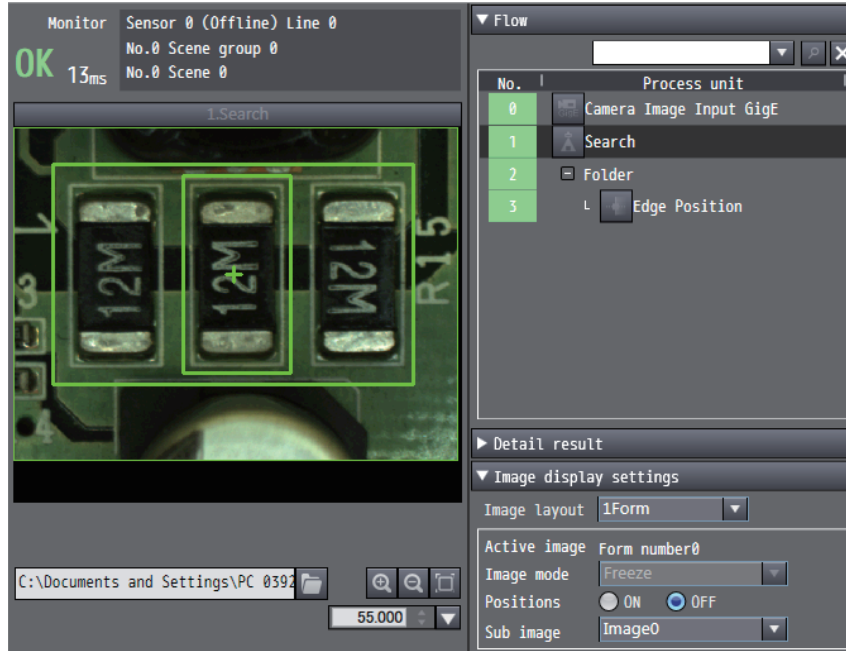

Additional Information

If the run mode (Status Flag: Run Mode) of the response area is OFF when simulation is executed, open the Monitor window. When the Monitor window is opened, the run mode changes to ON.



Precautions for Correct Use

- Simulations of sensor control programs can only be executed for a single FH/FHV vision sensor at a time while the sensor settings are being edited offline. You cannot run simulations for multiple FH/FHV vision sensors at the same time.
- The vision sensor currently being edited offline will have <Editing.> added to the end of the **Type** in the Multiview Explorer.
- For simulation, the Sysmac error status is not registered as an event in the Sysmac Studio troubleshooting window.

8

Other Useful Functions

This section provides a list of useful tools that can be used in the configuration and operation of the FH/FHV series vision sensors.

8-1	Using the Command Customize Setting Tool.....	8-3
8-2	Using the Calibration Support Tool.....	8-4
8-3	Using the File Save Tool.....	8-5
8-3-1	Opening the File Save Tool.....	8-5
8-3-2	Copying a File.....	8-5
8-3-3	Saving a Logging Image as a File.....	8-6
8-4	Using the User Data Setting Tool.....	8-7
8-5	Changing the System Environment.....	8-8
8-6	Help.....	8-10
8-7	Using the Security Setting Tool.....	8-11
8-8	Using the Scene Group Saving Destination Setting Tool.....	8-12
8-9	Using the Image File Save Tool.....	8-13
8-9-1	Opening the Image File Save Tool.....	8-13
8-9-2	Saving the Image File.....	8-13
8-9-3	Saving the Logged Images to Files.....	8-14
8-10	Using the Registered image Manager.....	8-16
8-11	Using the Update Standard Position Tool.....	8-17
8-12	Using the Conversion Scene Group Data Tool.....	8-18
8-13	Using the Scene Control Macro Tool.....	8-19
8-14	Print the Settings.....	8-20
8-15	Using the Variable Assignment List.....	8-21
8-15-1	Opening the Variable Assignment List.....	8-21
8-15-2	Check the Variable Assignment List.....	8-21
8-16	Using the Quick Access Setting Tool.....	8-22
8-16-1	Opening the Quick Access Setting Tool.....	8-22
8-16-2	Set the Quick Access.....	8-22
8-16-3	Set the Quick Access file save settings in Sysmac Studio.....	8-22
8-17	Using the Conveyor Panorama Display Tool.....	8-23
8-18	Using the Conveyor Calibration Wizard Tool.....	8-24

8-19	Using the Calibration Plate Print Tool	8-25
8-20	Using the Error Log Management Tool	8-26

8-1 Using the Command Customize Setting Tool

This tool allows you to edit custom commands.

It is the same as the **Tools - Communication Command Customize** function provided with the FH/FHV vision sensor.

For details, refer to *Vision System FH/FHV Series User's Manual (Cat. No. Z365)*.



Precautions for Correct Use

The decimal point symbol is fixed at "." (period), regardless of your computer's OS settings.

8-2 Using the Calibration Support Tool

A calibration support tool is available.

It is the same as the **Tools - Calibration Support Tool** function provided with the FH/FHV vision sensor.

For details, refer to *Vision System FH/FHV Series User's Manual (Cat. No. Z365)*.

8-3 Using the File Save Tool

The file save tool allows you to copy and transfer files in the external memory of the FH/FHV vision sensor. It also allows you to output logging image files in the FH/FHV vision sensor memory.

8-3-1 Opening the File Save Tool

To open the File Save Tool, select **Tools - Save file** in the Multiview Explorer and then either double-click **Save file** to pull up the Save screen or right-click and select **Edit** from the pop-up menu that appears.

The file management tool screen appears in the Edit pane.

8-3-2 Copying a File

You can copy a file in the external memory of the FH/FHV vision sensor and then save it under a different name or transfer it to the computer.

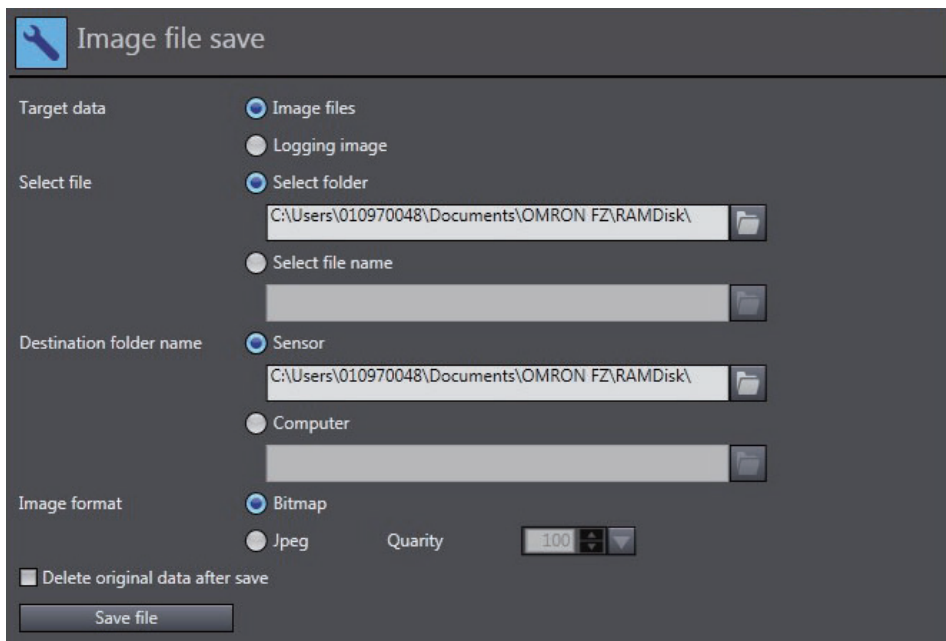

1 Select **File** for **Target data**.

2 Select the file.

You can select data on a folder basis or on a file basis.

If you select an individual folder, you can narrow down the files by type.

The following file types can be selected to narrow down the data.

- All files
- Logging images (*.ifz, *.byr)
- Bitmap (*.bmp)
- Jpeg (*.jpg)
- CSV (*.csv)
- Scene data (*.scn)
- Scene group data (*.sgp)

- System data (*.ini)
- System settings + Scene group 0 data (*.bkd)
- Operation log (*.log)

- 3** Select the save destination folder.

To save the file by copying it to the external memory of the FH/FHV vision sensor, select **Sensor**.

To save the file to the computer, select **Computer**.

If you wish to delete the original file after saving, select the **Delete original data after save** check box.
- 4** Save the file.

Click the **Save file** button to save the file.

The selected file is copied to the specified folder.

8-3-3 Saving a Logging Image as a File

You can save a logging image in the FH/FHV vision sensor memory as a file.

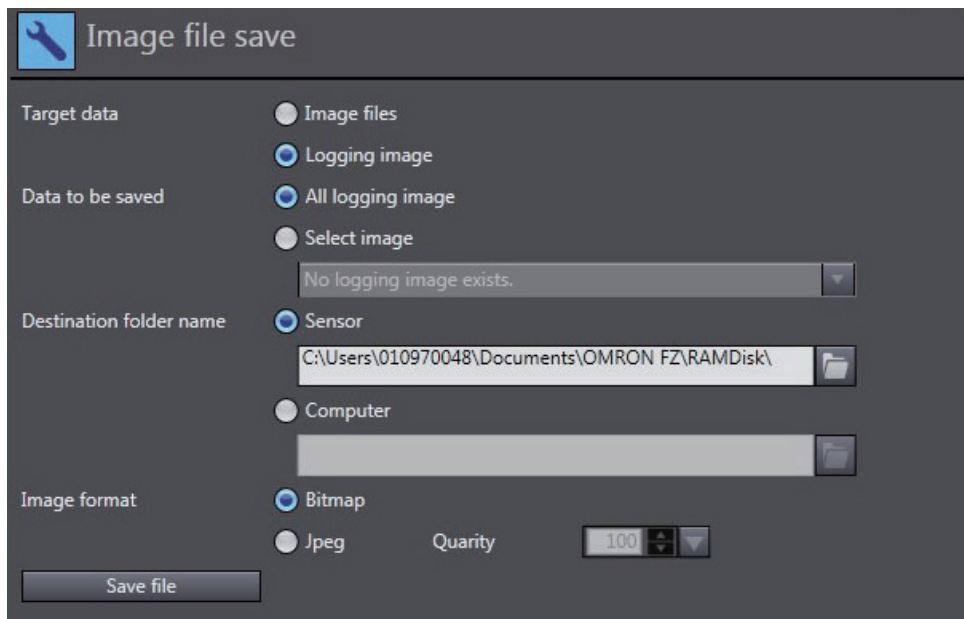

- 1** Select **Logging image** for **Target data**.
- 2** Select the save target.

Select whether to save all logging images or a particular logging image.
- 3** Select the save destination folder.

To save the file by copying it to the external memory of the FH/FHV vision sensor, select **Sensor**.

To save the file to the computer, select **Computer**.
- 4** Save the file.

Click the **Save file** button to save the file.

The selected logging file is output to the specified folder.

8-4 Using the User Data Setting Tool

This tool allows you to edit user data.

It is the same as the **Tool - User Data** function provided with the FH/FHV vision sensor.



For details, refer to *Vision System FH/FHV Series User's Manual (Cat. No. Z365)*.



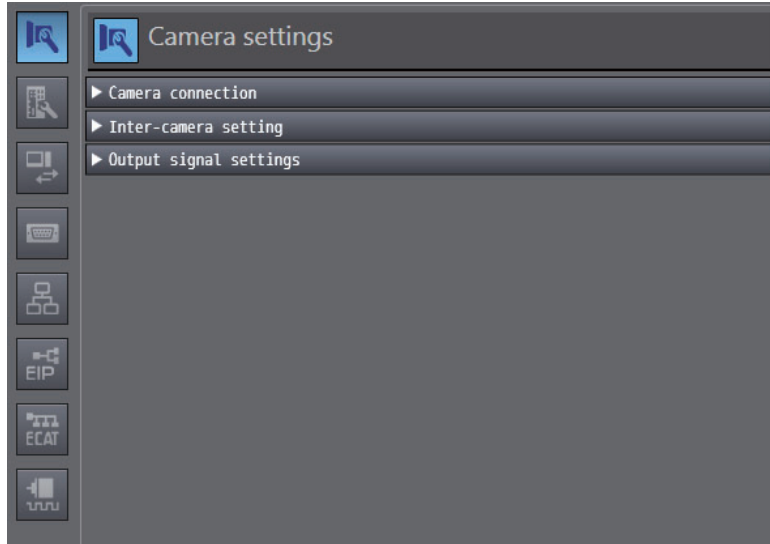

8-5 Changing the System Environment



You can change the system data for the FH/FHV vision sensor in the system data editing screen. Display the system data editing screen in the Edit Pane by double-clicking **System** in the Multiview Explorer or by right-clicking it and selecting **Edit** from the menu.



System data is classified into the groups shown in the following table. Clicking a group icon displays the editing items for the corresponding group. System data includes parameters that require a restart to reflect the settings.

If a parameter that requires a restart is edited, " " is displayed for the sensor type in the Multiview Explorer. If " " is displayed, save the settings and then restart the FH/FHV vision sensor. For details on restarting, refer to *2-4-4 Multiview Explorer* on page 2-11. For details on each setting item, refer to *Vision System FH/FHV Series User's Manual (Cat. No. Z365)*.

Button	Item	Sub Item
	Camera settings	Camera connection Inter-camera setting Output signal settings
	Controller settings	Startup settings Fan control setting STEP setting Network drive settings Measurement setting Image logging settings Data log settings Operation log settings
	Parallel I/O settings	Settings
	RS-232C/422 settings	Settings PLC link settings
	Ethernet settings	Address settings Input/Output settings PLC link settings

Button	Item	Sub Item
	EtherNet/IP settings	EtherNet/IP communication
	EtherCAT settings	EtherCAT communication
	Encoder settings	Encoder settings

8-6 Help

You can display the FH/FHV tool manual.

Display the sensor connection screen in the Edit Pane by double-clicking the **type** in the Multiview Explorer or by right-clicking it and selecting **Edit** from the menu.

Click **Sensor Information - Help** to display the manual for the FH/FHV series vision sensors.

8-7 Using the Security Setting Tool

With this tool, it is possible to edit the security settings.

This function is the same as the **Security Setting** function under the **Tool** menu in the FH/FHV vision sensor.

For details, refer to *Vision System FH/FHV Series User's Manual (Cat. No. Z365)*.

8-8 Using the Scene Group Saving Destination Setting Tool

With this tool, it is possible to edit the saving destination for the scene group.

This function is the same as the **Scene Group Saving Destination Setting** function under the **Tool** menu in the FH/FHV vision sensor.

For details, refer to *Vision System FH/FHV Series User's Manual (Cat. No. Z365)*.



Precautions for Correct Use

The Scene Group Saving Destination Setting tool cannot be used offline.

8-9 Using the Image File Save Tool

With this tool, it is possible to save the copy of both logged images and image files that are saved in the Image Sensor to a RAM disk or external memory device in FH/FHV vision sensor, or to a computer. The save image file format can be selected from “Bitmap” or “Jpeg”.

8-9-1 Opening the Image File Save Tool

Double-click on **Tool - Image file save** in the Multiview Explorer, or by right-clicking it and selecting **Edit** from the menu.

The image file save tool window is displayed in the Edit Pane.

8-9-2 Saving the Image File

The image files in the following media can be copied, and then saved in the same media or computer as bitmap or JPEG.

- RAMDisk of FH/FHV vision sensor
- Connected external memory to FH/FHV vision sensor

If the file is saved in the JPEG format, it is possible to specify the quality (compression ratio) for each file.

1 Select **Image files** for **Target data**.

2 Select the file.

You can select data on a folder basis or on a file basis.

3 Select the save destination folder.

To save the file by copying it to the external memory of the FH/FHV vision sensor, select **Sensor**.

To save the file to the computer, select **Computer**.

If you wish to delete the original file after saving, select the **Delete original data after save** check box.

4 Save the file.

Click the **Save file** button to save the file.

The selected file(s) are saved as the specified format.

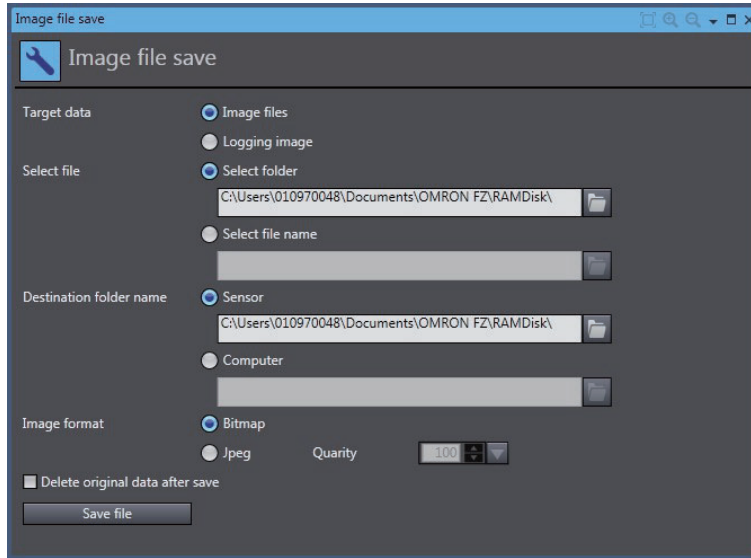

Setting item	Setting value	Description
Image format	<ul style="list-style-type: none"> • Bitmap • Jpeg 	Select the image format to be saved.
Quality	0 to 100	Set the quality of the Jpeg image to be saved.

8-9-3 Saving the Logged Images to Files

You can save a logging image in the FH/FHV vision sensor memory as a file.

- 1** Select **Logging image** for **Target data**.
- 2** Select the save target.
Select whether to save all logging images or a particular logging image.
- 3** Select the save destination folder.
To save the file by copying it to the external memory of the FH/FHV vision sensor, select **Sensor**.
To save the file to the computer, select **Computer**.
- 4** Save the file.
Click the **Save file** button to save the file.
The selected file(s) are saved as the specified format.

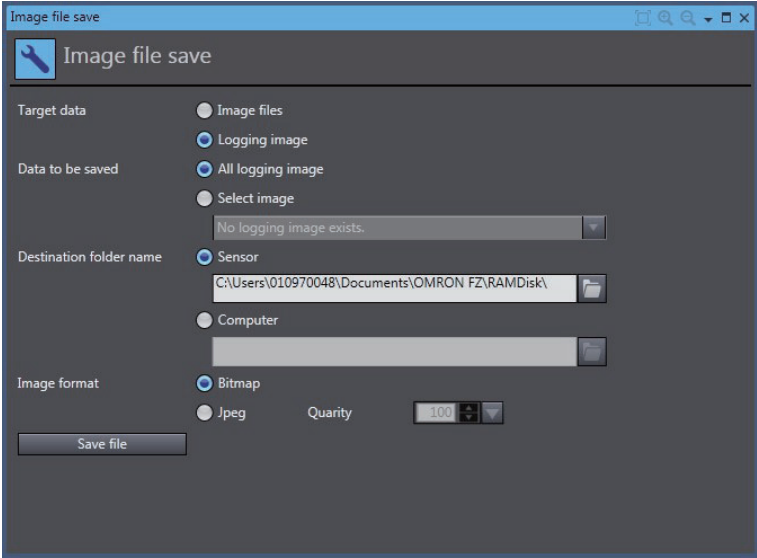

8-10 Using the Registered image Manager

With this tool, it is possible to save images used for model registration and reference registration as registration images. The saved images can be used for re-registration and adjustment of reference positions.

For details, refer to *Vision System FH/FHV Series User's Manual (Cat. No. Z365)*.

8-11 Using the Update Standard Position Tool

With this tool, it is possible to set or change all reference positions at once for multiple processing units registered in the measurement flow.

This functions the same as the **Update standard position tool** function under the **Tool** menu in the FH/FHV vision sensor.

For details, refer to *Vision System FH/FHV Series User's Manual (Cat. No. Z365)*.

8-12 Using the Conversion Scene Group Data Tool

With this tool, it is possible to create a scene group that has more than or equal to 129 scenes.

This function is the same as the **Conversion scene group data tool** function under the **Tool** menu in the FH/FHV vision sensor.

For details, refer to *Vision System FH/FHV Series User's Manual (Cat. No. Z365)*.

8-13 Using the Scene Control Macro Tool

With this tool, it is possible to supplement and expand measurement flow and scene control.

This function is the same as the **Scene Control macro tool** function under the **Tool** menu in the FH/FHV vision sensor.

For details, refer to *Vision System FH/FHV Series User's Manual (Cat. No. Z365)*.

For details, refer to *Vision System FH series Macro Customize Functions Programming Manual (Cat. No. Z367)*.

8-14 Print the Settings

With this function, it is possible to print the parameters set in the system data and currently selected scene data.

Target data	Description
All information	Prints all of the sensor information, and parameters set in the system data and the currently selected scene data.
Scene data	Prints parameters set in the currently selected scene data.
System data	Prints parameters set in the system data.
Processing unit	Prints parameters set in the processing units.

- 1 Open the print window.
Right-click on **LineX** in the Multiview Explorer and select **Print**.
The **Print** window is displayed in the Edit pane.

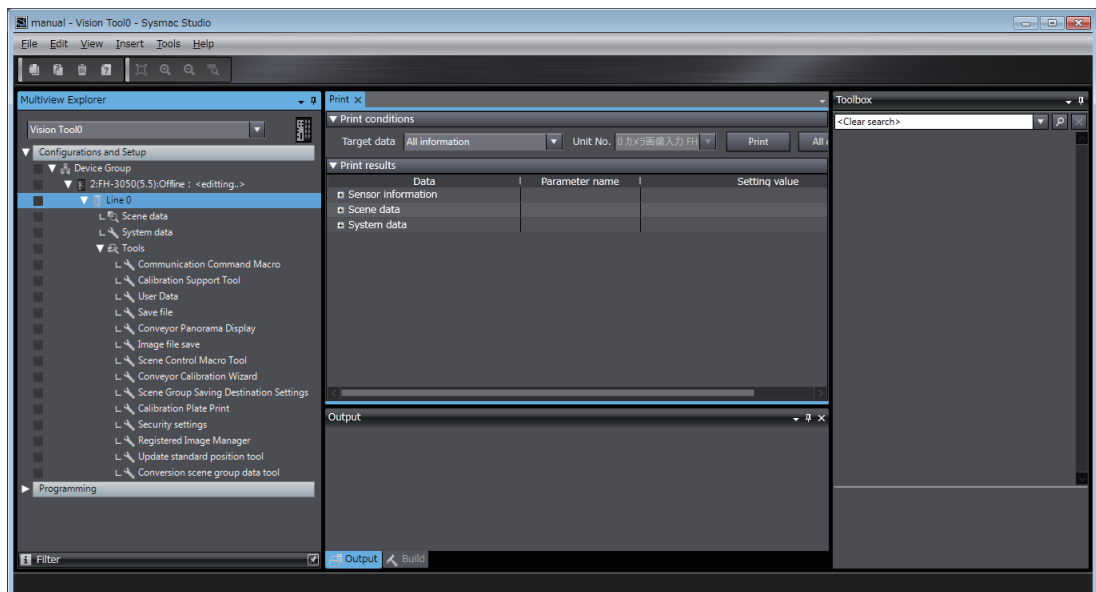

- 2 Select the data to be printed.
Select the data to be printed from **Target data**.
Unit No. should be selected when processing unit is selected from **Target data**.
Select the parameter to be printed and expand the tree.
Click on **Expand all** to show all parameters.
- 3 Initiate printing.
Click on **Print** to print out the parameters shown.



Precautions for Correct Use

This command prints out only the parameters downloaded and uploaded with the Settings download and upload tools. For details on the **Settings download and upload tools**. For details, refer to *Vision System FH/FHV Series User's Manual (Cat. No. Z365)*.

8-15 Using the Variable Assignment List

Displays the assignment list of the System variables and Scene variables registered in the FH/FHV. For the System variables and Scene variables, refer to *Vision System FH/FHV Series User's Manual* (Cat. No. Z365).

8-15-1 Opening the Variable Assignment List

Double-click on **Tool - Variable assignment list** in the Multiview Explorer, or by right-clicking it and selecting **Edit** from the menu.

The Variable assignment list window is displayed in the Edit Pane.

8-15-2 Check the Variable Assignment List

Displays the variable assignment list set in the **TDM editor**.

The variable data can be saved to or load from a file.

For the TDM editor, refer to *Vision System FH/FHV Series User's Manual* (Cat. No. Z365).

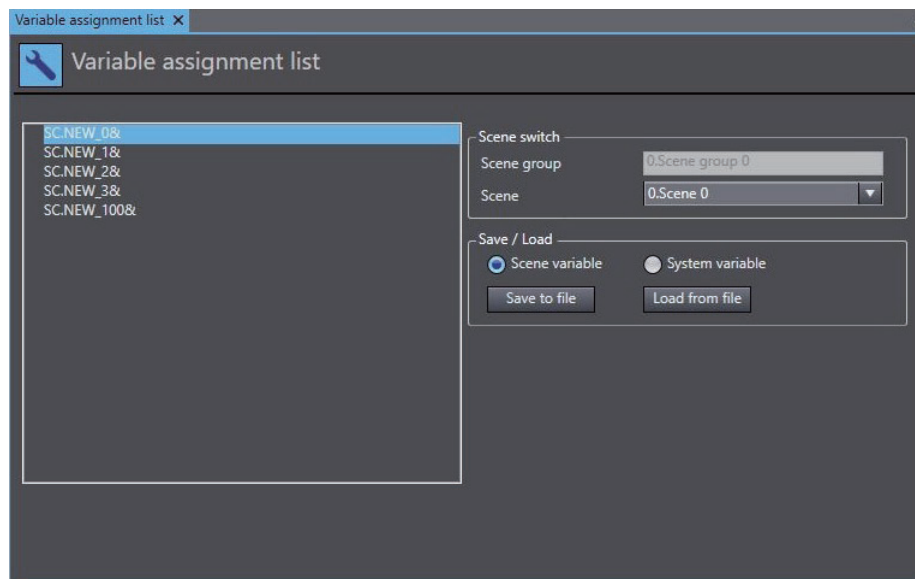

Item	Set value	Description
Scene switch		
Scene group	-	The current scene group number and scene group name are displayed.
Scene	0 to 127	Set the scene to display the variable assignment List.
Save / Load	<ul style="list-style-type: none"> • Scene variable • System variable 	Select the variables to save file to file or load from file.
Save to file	-	Click to save the selected variable in a .csv file.
Load from file	-	Click to load from .csv file and register as selected variable.

8-16 Using the Quick Access Setting Tool

With this tool, it is possible to set the quick access "Ident name", "Absolute path", and "Display name". By setting the quick access, you can select the quick access when specifying the path of the file or folder. By setting for each environment, various paths can be set without paying attention to the environment-dependent drive configuration.

8-16-1 Opening the Quick Access Setting Tool

Double-click on **Tool - Quick access setting tool** in the Multiview Explorer, or by right-clicking it and selecting **Edit** from the menu.

The Quick access setting tool window is displayed in the Edit Pane.

8-16-2 Set the Quick Access

This function is the same as the **Quick access setting tool** function under the **Tool** menu in the FH/FHV vision sensor.

For details, refer to *Vision System FH/FHV Series User's Manual (Cat. No. Z365)*.

8-16-3 Set the Quick Access file save settings in Sysmac Studio



Item	Set value	Description
Save file	<ul style="list-style-type: none"> Checked Unchecked 	If checked, the files in Quick Access will be saved when saving/exporting the Sysmac Studio project.
Load file	<ul style="list-style-type: none"> Checked Unchecked 	If checked, the files in Quick Access will be overwritten when a project of Sysmac Studio is opened/imported. It will be overwritten if a file with the same file name as the file in Quick Access exists.

8-17 Using the Conveyor Panorama Display Tool

This tool is used for conveyor tracking applications.

This tool is used to display a panoramic composition of workpieces being carried by conveyor. To adjust the trigger interval and conveyor speed for additional lines or new product types, this tool combines images to create a panoramic image, and then displays the region of captured image and the registered region of the model of the target objects over it.

For details, refer to *Vision Sensor FH series Conveyor Tracking Application Programming Guide (Cat. No. Z368)*.

8-18 Using the Conveyor Calibration Wizard Tool

This tool is used for conveyor tracking applications to reciprocally convert different coordinates for image sensor, conveyor, and robots by giving instructions in a wizard-style.

For details, refer to *Vision Sensor FH series Conveyor Tracking Application Programming Guide (Cat. No. Z368)*.

8-19 Using the Calibration Plate Print Tool

This tool is used for conveyor tracking applications to print Calibration Pattern.

For details, refer to *Vision Sensor FH Operation Manual (Sysmac Studio Calibration Plate Print Tool)* (Cat. No. Z369).

8-20 Using the Error Log Management Tool

You can check the log information for camera connection errors, battery errors, and other errors.

The log information can be saved as error log information files, making it easier to identify the causes of errors.

For details, refer to *Vision System FH/FHV Series User's Manual (Cat. No. Z365)*.



Limitations

This section provides a list of the limitations associated with the use of the FH/FHV sensor controller with the FH/FHV tools.

9-1	Limitations	9-2
9-2	Synchronization with the NJ/NX/NY-series Controllers	9-8

9-1 Limitations

The FH/FHV tools have the following limitations.

Condition	Limitation
Editing of processing units	Limitations apply to editing processing units in Sysmac Studio. Refer to the following table.



Precautions for Correct Use

The below application will run while the FH vision sensor is being edited offline.

- FZ-CoreRA 0.exe

Do not attempt to exit this application manually.

Exiting this application prematurely may cause problems to arise with the FH/FHV editing.

Should the application be closed accidentally, end Sysmac Studio, restart the computer, and try again.

● List of the processing units supported in Sysmac Studio (FH tools)

Yes: Supported, No: Not supported

Processing Unit	Registration	Editing
Camera Image Input	Yes	No
Camera Image Input FH	Yes	Yes
Camera Image Input FHV	Yes*6	No
Camera Image Input HDR	Yes	Yes
Camera Image Input HDR Lite	Yes	Yes
Photometric Stereo Image Input	Yes*5	Yes*5
Camera Switching	Yes	Yes
Measurement Image Switching	Yes	Yes
Multi-Trigger Imaging	Yes*4	Yes*4
Multi-Trigger Imaging Task	Yes*4	Yes*4
Position Compensation	Yes	Yes
Filtering	Yes	Yes
Background Suppression	Yes	Yes
Brightness Correct Filter	Yes	Yes*1
Advanced Filter	Yes	Yes
Image Subtraction	Yes	Yes*1
Color Gray Filter	Yes	Yes
Extract Color Filter	Yes	Yes
Anti Color Shading	Yes	Yes
Stripes Removal Filter II	Yes	Yes
Polar Transformation	Yes	Yes
Trapezoidal Correction	Yes	Yes
AI Scratch Detect Filter	Yes*8	No
Panorama	Yes	Yes*1
Machine Simulator	Yes	Yes
Search	Yes	Yes

Processing Unit	Registration	Editing
Search II	Yes ^{*7}	Yes ^{*7}
Flexible Search	Yes	Yes
Sensitive Search	Yes	Yes ^{*1}
EC Circle Search	Yes	Yes
ECM Search	Yes	Yes
EC Corner	Yes	Yes
EC Cross	Yes	Yes
Shape Search II	Yes	Yes
Shape Search III	Yes	Yes
Classification	Yes	Yes ^{*1}
Edge Position	Yes	Yes
Edge Pitch	Yes	Yes ^{*1}
Scan Edge Position	Yes	Yes
Scan Edge Width	Yes	Yes ^{*1}
Circular Scan Edge Position	Yes	Yes
Circular Scan Edge Width	Yes	Yes ^{*1}
Intersection	Yes	Yes
Gravity and Area	Yes	Yes
Labeling	Yes	Yes
Label Data	Yes	Yes
Color Data	Yes	Yes ^{*1}
Defect	Yes	Yes ^{*1}
Precise Defect	Yes	Yes ^{*1}
Fine Matching	Yes	Yes ^{*1}
2D Code II	Yes ^{*5}	Yes ^{*5}
2D Code	Yes	Yes ^{*1}
Barcode	Yes	Yes ^{*1}
Character Inspection	Yes	Yes ^{*1}
Model Dictionary	Yes	Yes ^{*1}
Date Verification	Yes	Yes ^{*1}
Circle Angle	Yes	Yes
Glue Bead Inspection	Yes	Yes ^{*1}
AI Fine Matching	Yes ^{*8}	No
OCR	Yes ^{*2}	Yes ^{*2}
OCR User Dictionary	Yes ^{*2}	Yes ^{*2}
Calculation	Yes	Yes
Unit Calculation Macro	Yes	Yes ^{*1}
Circle Regression	Yes	Yes
Line Regression	Yes	Yes
Movement Single Position	Yes	Yes
Movement Multi Points	Yes	Yes
Convert Position Data	Yes	Yes
Position Data Calculation	Yes	Yes
Precise Calibration	Yes	Yes

Processing Unit	Registration	Editing
Vision Master Calibration	Yes	Yes
PLC Master Calibration	Yes	Yes
Reference Calib Data	Yes	Yes
Camera Calibration	Yes	Yes
Get Unit Data	Yes	Yes
Get Unit Figure	Yes	Yes
Set Unit Data	Yes	Yes
Set Unit Figure	Yes	Yes
Detection Point	Yes	Yes
Manual Position Setting	Yes ^{*5}	Yes ^{*5}
Image Logging	Yes	Yes
Image Conversion Logging	Yes	Yes
Data Logging	Yes	Yes
Trend Monitor	Yes	Yes
Statistics	Yes	Yes
User Data	Yes	Yes
Data Save	Yes	Yes
Robot Data	Yes	Yes
Stage Data	Yes	Yes
Conveyor Calibration	Yes ^{*3}	Yes ^{*3}
Scene	Yes ^{*5}	Yes ^{*5}
System Information	Yes ^{*5}	Yes ^{*5}
Iris	Yes	Yes ^{*1}
Focus	Yes	Yes ^{*1}
Unit Macro	Yes	Yes ^{*1}
Wait	Yes	Yes
Elapsed Time	Yes	Yes
Parallelize	Yes	Yes
Parallelize Task	Yes	Yes
Conditional Branch	Yes	Yes
DI Branch	Yes	Yes
End	Yes	Yes
Selective Branch	Yes	Yes
Control Flow Normal	Yes	Yes
Control Flow PLC Link	Yes	Yes
Control Flow Parallel	Yes	Yes
Control Flow Fieldbus	Yes	Yes
Conditional Execution (If)	Yes ^{*5}	Yes ^{*5}
Conditional Execution (Else)	Yes ^{*5}	Yes ^{*5}
Loop	Yes ^{*5}	Yes ^{*5}
Loop Suspension	Yes ^{*5}	Yes ^{*5}
Select Execution (Select)	Yes ^{*5}	Yes ^{*5}
Select Execution (Case)	Yes ^{*5}	Yes ^{*5}
Result output (I/O)	Yes ^{*5}	Yes ^{*5}
Result output (Message)	Yes ^{*5}	Yes ^{*5}

Processing Unit	Registration	Editing
Result output (Parallel I/O)	Yes ^{*7}	Yes ^{*7}
Parallel Judgment Output	Yes	Yes
Data Output	Yes	Yes
Parallel Data Output	Yes	Yes
Fieldbus Data Out	Yes	Yes
Result Display	Yes	Yes
Display Image File	Yes	Yes
Display Last NG Image	Yes	Yes
Conveyor Panorama Display	Yes ^{*3}	Yes ^{*3}
Display Image Hold	Yes ^{*5}	Yes ^{*5}

- *1. Sysmac Studio ver.1.09 or later is required to register and edit the processing item(s).
 *2. FH Sensor Controller ver.5.20 or later is required to register and edit the processing item(s).
 *3. FH Sensor Controller ver.5.50 or later is required to register and edit the processing item(s).
 *4. FH Sensor Controller ver.5.70 or later is required to register and edit the processing item(s).
 *5. FH Sensor Controller ver.6.10 or later is required to register and edit the processing item(s).
 *6. FH Sensor Controller ver.6.20 or later is required to register the processing item(s).
 *7. FH Sensor Controller ver.6.30 or later is required to register and edit the processing item(s).
 *8. FH Sensor Controller ver.6.40 or later is required to register the processing item(s).

● List of the processing units supported in Sysmac Studio (FHV tools)

Yes: Supported, No: Not supported

Processing Unit	Registration	Editing
Camera Image Input	Yes	No
Camera Image Input FH	Yes	No
Camera Image Input FHV	Yes	Yes
Camera Image Input HDR	Yes	Yes
Measurement Image Switching	Yes	Yes
Multi-Trigger Imaging	Yes	Yes
Multi-Trigger Imaging Task	Yes	Yes
Position Compensation	Yes	Yes
Filtering	Yes	Yes
Background Suppression	Yes	Yes
Brightness Correct Filter	Yes	Yes
Advanced Filter	Yes	Yes
Image Subtraction	Yes	Yes
Color Gray Filter	Yes	Yes
Extract Color Filter	Yes	Yes
Anti Color Shading	Yes	Yes
Stripes Removal Filter II	Yes	Yes
Polar Transformation	Yes	Yes
Trapezoidal Correction	Yes	Yes
AI Scratch Detect Filter	No	No
Search	Yes	Yes
Search II	Yes	Yes
Flexible Search	Yes	Yes
Sensitive Search	Yes	Yes

Processing Unit	Registration	Editing
Shape Search III	Yes	Yes
Classification	Yes	Yes
Edge Position	Yes	Yes
Edge Pitch	Yes	Yes
Scan Edge Position	Yes	Yes
Scan Edge Width	Yes	Yes
Circular Scan Edge Position	Yes	Yes
Circular Scan Edge Width	Yes	Yes
Intersection	Yes	Yes
Gravity and Area	Yes	Yes
Labeling	Yes	Yes
Color Data	Yes	Yes
Precise Defect	Yes	Yes
Fine Matching	Yes	Yes
2D Code II	Yes	Yes
2D Code	Yes	Yes
Barcode	Yes	Yes
Character Inspection	Yes	Yes
Model Dictionary	Yes	Yes
Date Verification	Yes	Yes
Glue Bead Inspection	Yes	Yes
AI Fine Matching	No	No
OCR	Yes	Yes
OCR User Dictionary	Yes	Yes
Calculation	Yes	Yes
Circle Regression	Yes	Yes
Line Regression	Yes	Yes
Movement Single Position	Yes	Yes
Movement Multi Points	Yes	Yes
Convert Position Data	Yes	Yes
Position Data Calculation	Yes	Yes
Precise Calibration	Yes	Yes
Vision Master Calibration	Yes	Yes
Reference Calib Data	Yes	Yes
Camera Calibration	Yes	Yes
Image Logging	Yes	Yes
Image Conversion Logging	Yes	Yes
Trend Monitor	Yes	Yes
Statistics	Yes	Yes
Robot Data	Yes	Yes
Stage Data	Yes	Yes
Scene	Yes	Yes
System Information	Yes	Yes
Wait	Yes	Yes
Elapsed Time	Yes	Yes
Parallelize	Yes	Yes
Parallelize Task	Yes	Yes

Processing Unit	Registration	Editing
End	Yes	Yes
Conditional Execution (If)	Yes	Yes
Conditional Execution (Else)	Yes	Yes
Loop	Yes	Yes
Loop Suspension	Yes	Yes
Select Execution (Select)	Yes	Yes
Select Execution (Case)	Yes	Yes
Result output (I/O)	Yes	Yes
Result output (Message)	Yes	Yes
Result output (Parallel I/O)	Yes	Yes
Result Display	Yes	Yes
Display Last NG Image	Yes	Yes
Display Image Hold	Yes	Yes



Precautions for Correct Use

FHV Sensor ver.6.30 or later is required to register and edit the processing item(s).

9-2 Synchronization with the NJ/NX/NY-series Controllers

For details on the synchronization to the NJ/NX/NY-series controller, refer to *Sysmac Studio Version 1 Operation Manual (Cat. No. W504)*.

Consider the following limitations when synchronizing the project with the NJ/NX/NY-series controller to which the FH/FHV vision sensor is connected.

● Downloading ([Transfer to Controller])

- The setting data in FH/FHV vision sensor are not downloaded
- To download the setting data in FH/FHV vision sensor, establish an online connection for the vision sensor. Refer to *2-8 Precautions on Synchronization through an NJ/NX/NY-series Controller* on page 2-45.
- The global variables allocated to the FH/FHV vision sensor I/O ports in the I/O Map are downloaded.

● Uploading ([Transfer to computer])

- The setting data in FH/FHV vision sensor are not uploaded.
- The FH/FHV vision sensor setting data are initialized after uploading. Be sure to establish an online connection for FH/FHV vision sensor before the synchronization. Refer to *2-8 Precautions on Synchronization through an NJ/NX/NY-series Controller* on page 2-45.
- The global variables allocated to the FH/FHV vision sensor I/O ports in the I/O Map are downloaded.

Troubleshooting

10-1	Troubleshooting for EtherCAT	10-2
10-2	Sysmac Error Status	10-3

10-1 Troubleshooting for EtherCAT

For details on how to perform troubleshooting for EtherCAT, refer to *Vision System FH/FHV Series User's Manual for Communications Settings (Cat. No. Z342)*.

10-2 Sysmac Error Status

For details on Sysmac error statuses, refer to *Vision System FH/FHV Series User's Manual for Communications Settings (Cat. No. Z342)*.



Appendices

A-1	Sysmac Device Features	A-2
A-1-1	Sysmac Error Status	A-2
A-1-2	Saving the Node Address Setting	A-2
A-1-3	Serial Number Display	A-3
A-1-4	Compliance with ESI Specification (ETG.2000 S (R) V1.0.1).....	A-3
A-1-5	SII Data Check.....	A-3
A-1-6	Support for the Cable Redundancy	A-4

A-1 Sysmac Device Features

The control device product designed according to standardized communications and user interface specifications for OMRON control devices are called a Sysmac Device.

And the features available with such a Device is called Sysmac Device Features.

A-1-1 Sysmac Error Status

Because, in Sysmac Devices, errors that may occur in slaves are systematized, you can check the causes and remedies for errors with a common procedure.

The status of an error can be monitored in the Sysmac Error Status (2002-01 hex). To display the error status detected by the FH series Vision Sensor in Sysmac Studio, the Sysmac Error Status (2002-01 hex) must be mapped to the PDO. Sysmac Studio, by default, uses the 512th transmit PDO Mapping assignment to map the Sysmac Error Status (2002-01 hex) automatically to the PDO.



Additional Information

- For the Sysmac Error status (2002-01 hex), refer to *Vision System FH/FHV Series User's Manual for Communications Settings (Cat. No. Z342)*.
- For errors displayed in Sysmac Studio, refer to *NJ/NX-series Troubleshooting Manual (Cat. No. W503)*.

A-1-2 Saving the Node Address Setting

When the node address switch setting is 00 (Software Setup mode), the node address value you set in Sysmac Studio is enabled. If the node address switches are set to any other value, the value that is set on the switches is used as the node address.

In the Software Setup mode, in Sysmac Studio, execute **Write Slave Node Address** on the **EtherCAT Edit** screen to save the slave node address setting in the nonvolatile memory of the FH series Vision Sensor.

Software Setting

The set value saved as Slave Information Interface (SII) information in the nonvolatile memory of the slave is the node address.

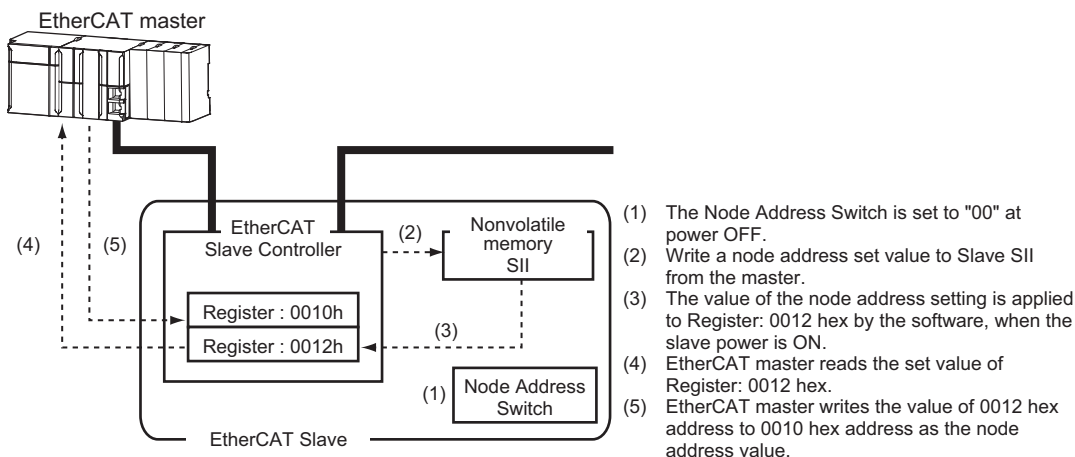

Node Address Switch Setting

The value set on the node address switches is the node address.

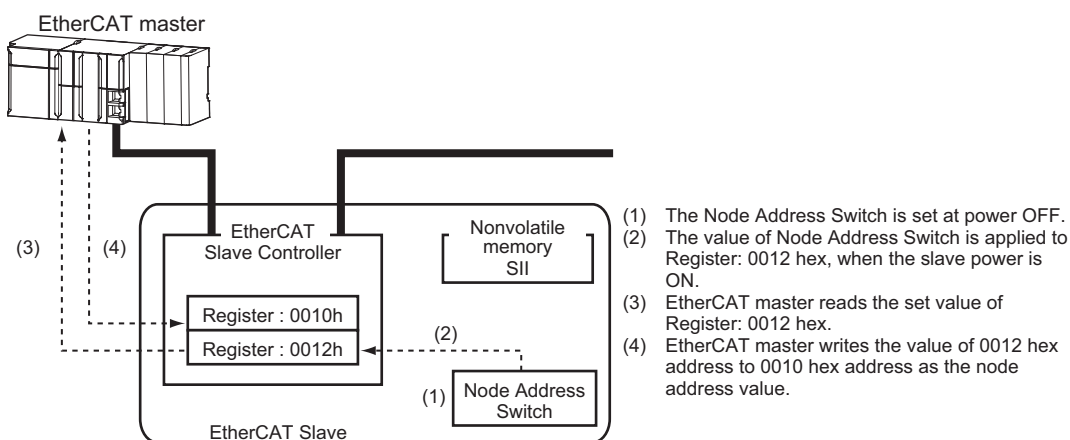

A-1-3 Serial Number Display

The serial number saved in the nonvolatile memory of the Vision Sensor is displayed in the Serial Number (1018-04 hex). Controllers that support Sysmac Device Features can use this serial number to check the network configuration.

To enable this check, in Sysmac Studio, set **Serial No. Check Condition** to **Set Value = Actual Unit** on the **EtherCAT Edit** screen.

If the set condition is not met, a Network Configuration Check Error will occur.



Additional Information

This network configuration check detects any slave devices that have been replaced, which prevents you from forgetting to set parameters on those slaves.

A-1-4 Compliance with ESI Specification (ETG.2000 S (R) V1.0.1)

The ESI Specification is a set of specifications that define the entries required in an EtherCAT Slave Information (ESI) file.

A-1-5 SII Data Check

The Slave Information Interface (SII) is an interface area in the nonvolatile memory of an EtherCAT slave that stores the configuration information specific to that EtherCAT slave. Sysmac Device EtherCAT slaves check the SII information from the slave side. If one of these slaves finds that SII information with which it cannot operate was written, it generates an SII Check Error (Error No. 88.3). If this error persists even after turning OFF and then ON the power again, contact your OMRON sales representative.



Precautions for Correct Use

Do not use third-party or any other configuration tools to edit the SII information.

A-1-6 Support for the Cable Redundancy

Item	Unit version 1.1	Unit version 1.2
Support for the cable redundancy* ¹ (Minimum value of the communications cycle: 125 μ s)* ²	Not supported.	Supported.* ³

*1. The cable redundancy can be realized by configuring a ring topology. It depends on the specifications of the EtherCAT master to be used whether a ring topology can be configured or not. Confirm the specifications of the EtherCAT master to be used.

*2. If the slave device is operated at a cycle shorter than the minimum value of the communications cycle, the EtherCAT frame may be lost or the communications may be disabled.

*3. FH-5550/FH-5550-10/FH-5550-20, FH-5050/FH-5050-10/FH-5050-20, FH-2050/FH-2050-10/FH-2050-20, and FHV7H are not supported.



Index



Index

Numerics

2Form display..... 6-6

A

Adding a Processing Unit..... 2-36
 Adding FH/FHV Device to a Project..... 2-8
 Adding FH/FHV Series Vision Sensor on the Network to a Project..... 3-3
 Application Considerations..... 13
 Application Window..... 2-10
 Author..... 2-34
 Available application memory..... 2-15

B

Basic Design Flow 1..... 2-3
 Basic Design Flow 2..... 2-5
 Basic Operations of Flow Editing..... 2-36
 Basic Operations of Scene Data..... 2-32
 binarization level..... 4-11
 Binary..... 4-11
 Binary Reverse..... 4-11
 Branch..... 4-3

C

Calibration Plate Print Tool..... 8-25
 Calibration Support Tool..... 8-4
 Category..... 2-7
 Changing the Image Display Settings..... 6-5
 Changing the System Environment..... 8-8
 Checking Measurement Results..... 6-4
 Checking Multiple Measurement Images at the Same Time..... 6-6
 Checking Result Output..... 6-7
 Check the Variable Assignment List..... 8-21
 Circumference..... 4-9
 Color..... 4-11
 Color Extraction..... 4-10
 Command Customize Setting Tool..... 8-3
 Comment..... 2-15
 Comparison with FH Series Unit Functions..... 2-42
 Comparison with FHV Series Unit Functions..... 2-43
 Compensate Image..... 4-2
 Configuring Measurement Settings..... 4-1
 Connect..... 2-15
 Connecting with a Vision Sensor..... 3-1
 Conversion Scene Group Data Tool..... 8-18
 Conveyor Calibration Wizard Tool..... 8-24
 Conveyor Panorama Display Tool..... 8-23
 Copying a File..... 8-5
 Creating a New Project..... 2-7
 Creating a New Project File from the Project Window..... 2-7

D

Data save..... 2-22, 2-26
 Deleting FH/FHV Device from a Project..... 2-9
 Description of Screen Components..... 2-10
 Designing Exchange with External Devices..... 5-1
 Detail result..... 2-19, 2-24, 2-27
 Detection Point..... 4-11
 Device..... 2-7
 device variables..... 2-3, 7-6
 Disclaimers..... 13
 Disconnect..... 2-15
 Display Result..... 4-3

E

Editing an Area..... 4-7
 Editing a Processing Unit..... 4-5
 Edit Pane..... 2-13
 Ellipse..... 4-8
 Ending a Connection in the Multiview Explorer..... 3-11
 Ending a Connection in the Sensor Connection Screen..... 3-11
 Ending a Connection with a Vision Sensor..... 3-11
 Entering Scene Group Information..... 2-35
 Entering Scene Information..... 2-33
 Error Log Management Tool..... 8-26
 Establishing an Online Connection from the Multiview Explorer..... 3-5
 Establishing an Online Connection from the Sensor Connection Screen..... 3-4
 Establishing an Online Connection with a Vision Sensor..... 3-4
 EtherCAT..... 5-2
 EtherCAT configuration..... 2-3
 Ethernet..... 5-2

F

File selection section..... 2-21, 2-27, 4-12
 Flow..... 2-18, 2-23, 2-26
 Form display..... 6-6
 Function List..... 2-40

H

Help..... 8-10

I

Image Control Area..... 4-12
 Image control section..... 2-21, 2-27, 4-12
 Image display area..... 2-17, 2-21
 Image display settings..... 2-19, 2-24
 Image File Save Tool..... 8-13
 Image layout..... 2-19, 2-24, 6-6
 Image mode..... 2-19, 2-24, 6-6
 Image size control section..... 2-17, 2-22, 4-12

- Initialize.....2-15
 Input Image.....4-2
 IP address.....2-15
- ## L
- Limitation on Liability; Etc.....12
 Limitations.....9-1
 List.....4-12
 List of Functions Provided with the FH/FHV Tool.....2-40
 Loading Settings Data.....6-10
 Logging in to a Registered User's Account.....3-12
- ## M
- Managing Processing Units.....2-37
 Managing Scene Groups.....2-34
 Managing Scenes.....2-33
 Measure.....2-22, 2-26
 Measurement.....4-2
 Measuring Camera Images.....6-2
 Measuring File Images in the RAMDisk or the External Memory, i.e. USB Flash Drive of the Vision Sensor.....6-3
 Measuring Logging Images in the Vision Sensor Memory.....6-3
 Menu Bar.....2-10
 Monitor window.....2-16
 Multiview Explorer.....2-11
- ## N
- New project.....2-3, 2-5
 Non-stop data transfer.....2-26
- ## O
- Offline Debugging.....7-1
 Offline Simulation.....7-2
 Online.....2-15
 Online Debugging.....6-1
 Opening the File Save Tool.....8-5
 Opening the Image File Save Tool.....8-13
 Opening the Quick Access Setting Tool.....8-22
 Opening the Variable Assignment List.....8-21
 Output.....2-22
 Output Result.....4-3
 Overview of Processing Units.....4-2
- ## P
- Parallel I/O.....5-2
 Performing Test Measurement.....6-2
 Polygon.....4-10
 Positions.....2-19, 2-24, 6-6
 Print the Settings.....8-20
 Processing unit
 Copy.....2-37
 Delete.....2-37
 Edit.....2-37
 Load from file.....2-37
 New folder.....2-37
 Paste.....2-37
 Rename.....2-37
 Save to file.....2-37
 PROFINET.....5-2
 Project.....1-3
 Project data.....1-3
 Project File.....2-7
 Project Management.....1-3
 Project Window.....2-7
- ## Q
- Quick Access Setting Tool.....8-22
- ## R
- Rectangle.....4-7
 Reference Point.....4-11
 Registered image Manager.....8-16
 RS-232C/422.....5-2
- ## S
- Saving a Logging Image as a File.....8-6
 Saving Measurement Results.....6-8
 Saving Settings Data.....6-9
 Saving the Image File.....8-13
 Saving the Logged Images to Files.....8-14
 Scene
 Copy.....2-33
 Delete.....2-33
 Load from file.....2-33
 Paste.....2-33
 Save to file.....2-33
 Scene Control Macro Tool.....8-19
 Scene data editing screen.....2-25
 Scene group
 Copy.....2-34
 Delete.....2-34
 Load from file.....2-34
 Paste.....2-34
 Save to file.....2-34
 Scene group Name.....2-35
 Scene Group Saving Destination Setting Tool.....8-12
 Scene maintenance area.....2-25
 Scene maintenance window.....2-20
 Scene Name.....2-34
 Search for sensors.....2-15
 Searching for a Processing Unit.....2-39
 Searching for a Scene.....2-34
 Security Setting Tool.....8-11
 Sensor connection screen.....2-15
 Sensor information.....2-15
 Sensor name.....2-15
 Sensor Restart.....2-15
 Set the Quick Access.....8-22
 Set the Quick Access file save settings in Sysmac Studio.....8-22
 slave parameter.....2-3
 Status display area.....2-16, 2-20

Sub image.....	2-20, 2-25, 6-6
Supported Models.....	1-2
Support Measurement.....	4-3
Switching Scene Groups.....	2-34
Switching Scenes.....	2-32
system data.....	8-8
System data editing screen.....	2-28

T

Terms and Conditions.....	12
Test measurement settings.....	2-22
Toolbar.....	2-11
Toolbox.....	2-30
Tool settings editing screen.....	2-29
Transfer data.....	2-26
Transferring Project Data to the Sensor.....	3-7
Transferring Setting data in the Sensor to a Project.....	3-9
Troubleshooting.....	10-1
Type.....	2-15

U

Update Standard Position Tool.....	8-17
User Data Setting Tool.....	8-7
Using the File Save Tool.....	8-5

V

Variable Assignment List.....	8-21
Version.....	2-15

W

Wide arc.....	4-9
Wide line.....	4-8

OMRON Corporation Industrial Automation Company

Kyoto, JAPAN

Contact : www.ia.omron.com

Regional Headquarters

OMRON EUROPE B.V.

Wegalaan 67-69, 2132 JD Hoofddorp
The Netherlands
Tel: (31) 2356-81-300 Fax: (31) 2356-81-388

OMRON ASIA PACIFIC PTE. LTD.

438B Alexandra Road, #08-01/02 Alexandra
Technopark, Singapore 119968
Tel: (65) 6835-3011 Fax: (65) 6835-2711

OMRON ELECTRONICS LLC

2895 Greenspoint Parkway, Suite 200
Hoffman Estates, IL 60169 U.S.A.
Tel: (1) 847-843-7900 Fax: (1) 847-843-7787

OMRON (CHINA) CO., LTD.

Room 2211, Bank of China Tower,
200 Yin Cheng Zhong Road,
PuDong New Area, Shanghai, 200120, China
Tel: (86) 21-5037-2222 Fax: (86) 21-5037-2200

Authorized Distributor:

©OMRON Corporation 2013-2022 All Rights Reserved.
In the interest of product improvement,
specifications are subject to change without notice.

Cat. No. Z343-E1-13 1222
Printed in Japan