

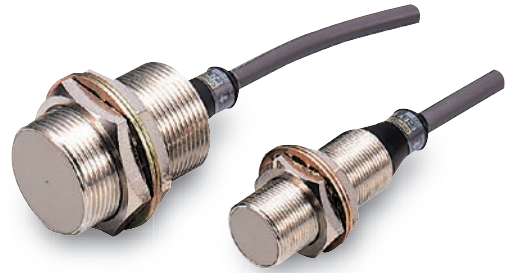

A Proximity Sensor for Aluminum, Brass and Other Non-ferrous Metals. Iron Is Not Detected.



- Non-ferrous metals, such as aluminum and brass, are detected. *
 - Ferrous metals, such as iron and nickel, are not detected.
- * Aluminum foil, however, cannot be detected.



 Be sure to read *Safety Precautions* on page 4.

Ordering Information

Sensors [Refer to *Dimensions* on page 4.]

Appearance		Sensing distance			Output configuration/Operation mode	Model
Shielded 	M18		4 mm		DC 3-wire, NPN NO	E2EY-X4C1 2M
	M30		8 mm			E2EY-X8C1 2M

Accessories (Order Separately)

[Mounting Brackets](#)

[Protective Covers](#)

[Sputter Protective Covers](#)

Refer to Y92□ for details.

Ratings and Specifications

Item	Model	E2EY-X4C1	E2EY-X8C1
Sensing distance		4 mm \pm 10%	8 mm \pm 10%
Set distance		0 to 2.8 mm	0 to 5.6 mm
Differential travel		20% max. of sensing distance	
Detectable object		Non-ferrous metal (Does not detect ferrous metal.)	
Standard sensing object		Aluminum: 18 \times 18 \times 1 mm	Aluminum: 30 \times 30 \times 1 mm
Response frequency *		70 Hz	
Power supply voltage (operating voltage range)		12 to 24 VDC (10 to 30 VDC), ripple (p-p): 10% max.	
Current consumption		20 mA max.	
Control output	Load current	NPN open-collector output, 100 mA max. (at 30 VDC)	
	Residual voltage	2 V max. (Load current: 100 mA, Cable length: 2 m)	
Indicators		Detection indicator (red)	
Operation mode (with sensing object approaching)		Load ON: NO (Refer to the timing charts under <i>I/O Circuit Diagrams</i> on page 3 for details.)	
Protection circuits		Reverse polarity protection, Load short-circuit protection, Surge suppressor	
Ambient temperature range		Operating/Storage: -10 to 55°C (with no icing or condensation)	
Ambient humidity range		Operating/Storage: 35% to 95% (with no condensation)	
Temperature influence		\pm 20% max. of sensing distance at 23°C in the temperature range of -10 to 55°C	
Voltage influence		\pm 2.5% max. of sensing distance at rated voltage in rated voltage \pm 15% range	
Insulation resistance		50 M Ω min. (at 500 VDC) between current-carrying parts and case	
Dielectric strength		1,000 VAC, 50/60 Hz for 1 minute between current-carrying parts and case	
Vibration resistance		Destruction: 10 to 55 Hz, 1.5-mm double amplitude for 2 hours each in X, Y, and Z directions	
Shock resistance		Destruction: 1,000 m/s ² 10 times each in X, Y, and Z directions	
Degree of protection		IEC 60529 IP67, in-house standards: oil-resistant	
Connection method		Pre-wired Models (Standard cable length: 2 m)	
Weight (packed state)		Approx. 140 g	Approx. 190 g
Materials	Case	Nickel-plated brass	
	Sensing surface	Heat-resistant ABS	
	Clamping nuts	Nickel-plated brass	
	Toothed washer	Zinc-plated iron	
Accessories		---	

* The response frequency is an average value. Measurement conditions are as follows: standard sensing object, a distance of twice the standard sensing object, and a set distance of half the sensing distance.

Engineering Data (Reference Value)

Sensing Area

E2EY-X4C1

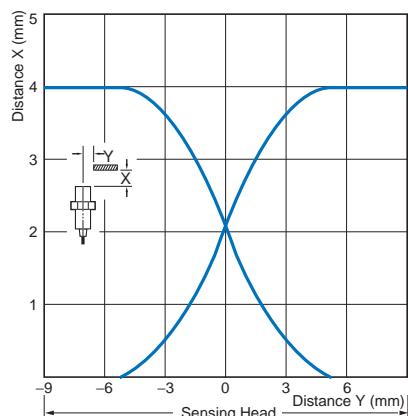

E2EY-X8C1

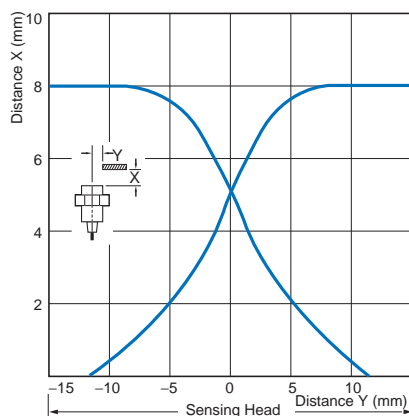

Influence of Sensing Object Size and Material

E2EY-X4C1

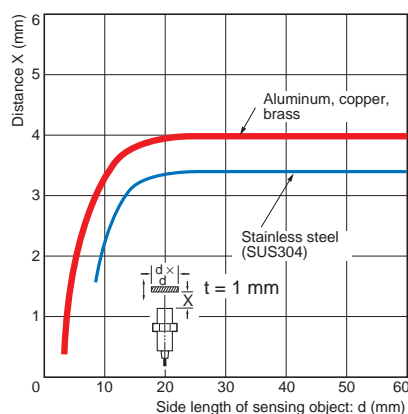

E2EY-X8C1

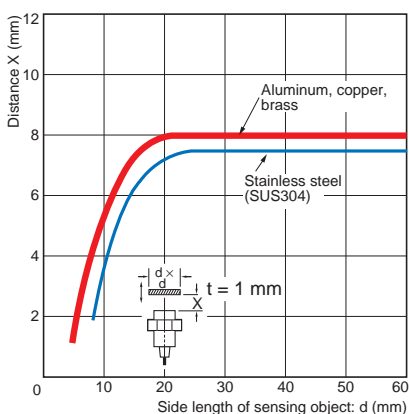

I/O Circuit Diagrams

DC 3-Wire Models

Operation mode	Model	Timing chart	Output circuit
NO	E2EY-X4C1 E2EY-X8C1	<p>Sensing object Present </p> <p>Not present </p> <p>Output transistor (load) ON </p> <p>OFF </p> <p>Detection indicator (red) ON </p> <p>OFF </p>	<p>* Load current: 100 mA max.</p>

Safety Precautions

Refer to *Warranty and Limitations of Liability*.

⚠ WARNING

This product is not designed or rated for ensuring safety of persons either directly or indirectly. Do not use it for such purposes.



Precautions for Correct Use

Do not use this product under ambient conditions that exceed the ratings.

● Design

Influence of Surrounding Metal

When mounting the Sensor within a metal panel, ensure that the clearances given in the following table are maintained. Failure to maintain these distances may cause deterioration in the performance of the Sensor.

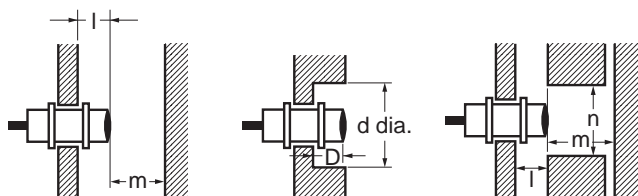

Influence of Surrounding Metal

(Unit: mm)

Model	Item	l	d	D	m	n
E2EY-X4C1		0	18	0	20	27
E2EY-X8C1			30		40	45

Mutual Interference

When installing Sensors face-to-face or side-by-side, ensure that the minimum distances given in the following table are maintained.

Mutual Interference (Unit: mm)

Model	Item	A	B
E2EY-X4C1		50	35
E2EY-X8C1		100	70

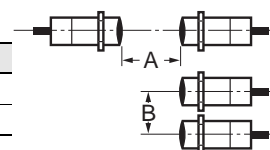

Note: Aluminum (non-ferrous metal) cannot be detected through iron (ferrous metal).

Mounting

Do not tighten the nut with excessive force. A toothed washer must be used with the nut.

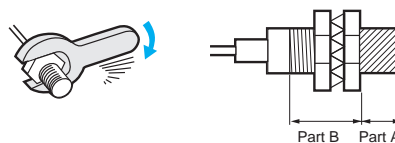

Note: 1. The allowable tightening strength depends on the distance from the edge of the head, as shown in the following table. (A is the distance from the edge of the head. B includes the nut on the head side. If the edge of the nut is in part A, the tightening torque for part A applies instead.)

2. The following torque assume washers are being used.

Tightening Torque	Part A		Part B
	Dimension (mm)	Torque	Torque
Model			
E2EY-X4C1	22	15 N·m	49 N·m
E2EY-X8C1	26	39 N·m	78 N·m

Dimensions

(Unit: mm)
Tolerance class IT16 applies to dimensions in this data sheet unless otherwise specified.

E2EY-X4C1

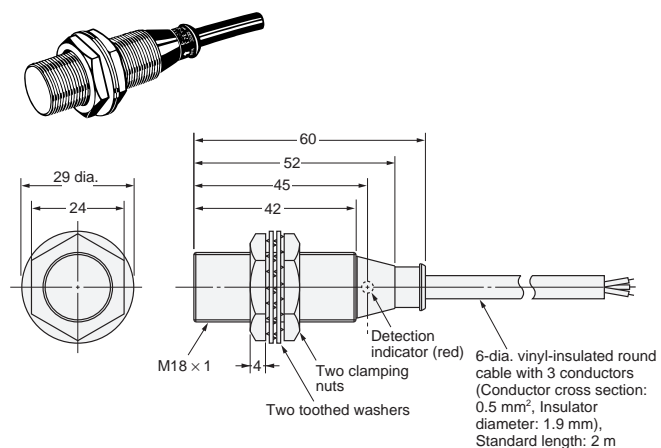

E2EY-X8C1

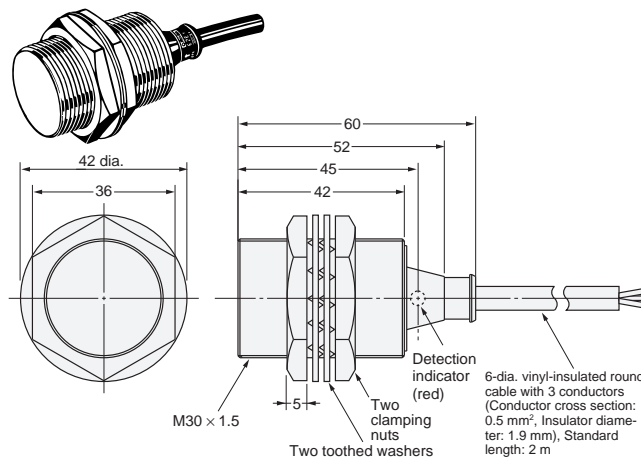

Mounting Hole Dimensions

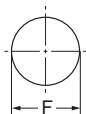

Model	F (mm)
E2EY-X4C1	18.5 ⁺⁵ ₀ dia.
E2EY-X8C1	30.5 ⁺⁵ ₀ dia.

Terms and Conditions Agreement

Read and understand this catalog.

Please read and understand this catalog before purchasing the products. Please consult your OMRON representative if you have any questions or comments.

Warranties.

(a) Exclusive Warranty. Omron's exclusive warranty is that the Products will be free from defects in materials and workmanship for a period of twelve months from the date of sale by Omron (or such other period expressed in writing by Omron). Omron disclaims all other warranties, express or implied.

(b) Limitations. OMRON MAKES NO WARRANTY OR REPRESENTATION, EXPRESS OR IMPLIED, ABOUT NON-INFRINGEMENT, MERCHANTABILITY OR FITNESS FOR A PARTICULAR PURPOSE OF THE PRODUCTS. BUYER ACKNOWLEDGES THAT IT ALONE HAS DETERMINED THAT THE PRODUCTS WILL SUITABLY MEET THE REQUIREMENTS OF THEIR INTENDED USE.

Omron further disclaims all warranties and responsibility of any type for claims or expenses based on infringement by the Products or otherwise of any intellectual property right. (c) Buyer Remedy. Omron's sole obligation hereunder shall be, at Omron's election, to (i) replace (in the form originally shipped with Buyer responsible for labor charges for removal or replacement thereof) the non-complying Product, (ii) repair the non-complying Product, or (iii) repay or credit Buyer an amount equal to the purchase price of the non-complying Product; provided that in no event shall Omron be responsible for warranty, repair, indemnity or any other claims or expenses regarding the Products unless Omron's analysis confirms that the Products were properly handled, stored, installed and maintained and not subject to contamination, abuse, misuse or inappropriate modification. Return of any Products by Buyer must be approved in writing by Omron before shipment. Omron Companies shall not be liable for the suitability or unsuitability or the results from the use of Products in combination with any electrical or electronic components, circuits, system assemblies or any other materials or substances or environments. Any advice, recommendations or information given orally or in writing, are not to be construed as an amendment or addition to the above warranty.

See <http://www.omron.com/global/> or contact your Omron representative for published information.

Limitation on Liability: Etc.

OMRON COMPANIES SHALL NOT BE LIABLE FOR SPECIAL, INDIRECT, INCIDENTAL, OR CONSEQUENTIAL DAMAGES, LOSS OF PROFITS OR PRODUCTION OR COMMERCIAL LOSS IN ANY WAY CONNECTED WITH THE PRODUCTS, WHETHER SUCH CLAIM IS BASED IN CONTRACT, WARRANTY, NEGLIGENCE OR STRICT LIABILITY.

Further, in no event shall liability of Omron Companies exceed the individual price of the Product on which liability is asserted.

Suitability of Use.

Omron Companies shall not be responsible for conformity with any standards, codes or regulations which apply to the combination of the Product in the Buyer's application or use of the Product. At Buyer's request, Omron will provide applicable third party certification documents identifying ratings and limitations of use which apply to the Product. This information by itself is not sufficient for a complete determination of the suitability of the Product in combination with the end product, machine, system, or other application or use. Buyer shall be solely responsible for determining appropriateness of the particular Product with respect to Buyer's application, product or system. Buyer shall take application responsibility in all cases.

NEVER USE THE PRODUCT FOR AN APPLICATION INVOLVING SERIOUS RISK TO LIFE OR PROPERTY OR IN LARGE QUANTITIES WITHOUT ENSURING THAT THE SYSTEM AS A WHOLE HAS BEEN DESIGNED TO ADDRESS THE RISKS, AND THAT THE OMRON PRODUCT(S) IS PROPERLY RATED AND INSTALLED FOR THE INTENDED USE WITHIN THE OVERALL EQUIPMENT OR SYSTEM.

Programmable Products.

Omron Companies shall not be responsible for the user's programming of a programmable Product, or any consequence thereof.

Performance Data.

Data presented in Omron Company websites, catalogs and other materials is provided as a guide for the user in determining suitability and does not constitute a warranty. It may represent the result of Omron's test conditions, and the user must correlate it to actual application requirements. Actual performance is subject to the Omron's Warranty and Limitations of Liability.

Change in Specifications.

Product specifications and accessories may be changed at any time based on improvements and other reasons. It is our practice to change part numbers when published ratings or features are changed, or when significant construction changes are made. However, some specifications of the Product may be changed without any notice. When in doubt, special part numbers may be assigned to fix or establish key specifications for your application. Please consult with your Omron's representative at any time to confirm actual specifications of purchased Product.

Errors and Omissions.

Information presented by Omron Companies has been checked and is believed to be accurate; however, no responsibility is assumed for clerical, typographical or proofreading errors or omissions.