

Uninterruptible Power Supply (UPS) Integrated battery type S8BA-LF



DC-DC type small UPS mounts on a DIN rail to provide an ideal countermeasure for momentary power losses and power failures in industrial computers (IPC) and controllers.

- System reliability greatly improved because 24VDC power supply is backed up for a certain period of time in the event of voltage drop or power failure.
- Compactness, weight reduction, and long battery life realized thanks to the adoption of a lithium-ion battery.
- Push-in terminal block adopted for the power input and output I/F.
- Shutdown in conjunction with the industrial purpose computer (IPC) or controller realized by the USB/RS-232C/I/O port installed in the UPS.



Refer to Safety Precautions on page 13.

Model Number Structure

Model Number Legend * Use the following format to place an order.

S8BA- □ □ □ □ □ □ □ □ **LF**
Series name 1 2 3

- | | |
|---------------------------------------|--------------------|
| 1. Input voltage specification | 3. Capacity |
| 24D: 24 VDC | 120: 120 W |
| | 240: 240 W |
| 2. Output voltage | 360: 360 W |
| 24D: 24 VDC | 480: 480 W |

Ordering Information

Main body
Uninterruptible Power Supply (UPS)

Input voltage	Output voltage	Output current/capacity	Model number
24 VDC	24 VDC	5 A/120 W	S8BA-24D24D120LF
		10 A/240 W	S8BA-24D24D240LF
		15 A/360 W	S8BA-24D24D360LF
		20 A/480 W *	S8BA-24D24D480LF

* 16.7 A/400 W for use as a UL compliant device.

Communication cable

Specifications	Type	Length	Model number
For RS-232C port	RJ45/Dsub9PIn	2 m	S8BW-C01
For CONTACT port	RJ45/Discrete wire		S8BW-C02

Replacement battery pack

Rated voltage	Rated capacity	Weight	Model	UPS Model : Required units
14.4 VDC	1600 mAh	0.3 kg	S8BA-B120L	S8BA-24D24D120LF : 1 pcs S8BA-24D24D240LF : 2 pcs S8BA-24D24D360LF : 3 pcs S8BA-24D24D480LF : 4 pcs

S8BA-LF

Ratings, Characteristics, and Functions

Item	Capacity	120 W	240 W	360 W	480 W *4	
DC input	Rated input voltage		24 VDC			
	Input voltage range	When standard voltage sensitivity is set	24 VDC±10%			
		When low voltage sensitivity is set	24 VDC±12.5%			
		When high voltage sensitivity is set	24 VDC±5%			
	Input maximum current	for rated input voltage for rated loads connected	5.9 A	11.7 A	17.5 A	23.3 A *5
	Input terminal		Push-in terminal block			
	Input protection		Fuse (cannot be replaced by the customer)			
Input protection capacity		10 A	15 A	30 A		
DC output	Rated current	(for rated output voltage)	5 A	10 A	15 A	20 A *6
	Switching time		Uninterrupted			
	Output voltage	Normal operation	Output of input voltage as-is			
		Backup operation	24 V±5%			
	Output terminal		Push-in terminal block			
	Overload protection		Alarm display at a load level of 110% or over (normal operation)			
Alarm display at a load level of 110% or over and output voltage drop (backup operation)						
Alarm display cancellation at a load equal to or below the rated capacity (normal operation, backup operation)						
Battery	Type		Lithium-ion battery			
	Rated voltage		14.4 VDC			
	Rated capacity		1600 mAh × 1 parallel	1600 mAh × 2 parallel	1600 mAh × 3 parallel	1600 mAh × 4 parallel
	Expected battery life *1		2.5 years (50°C), 5 years (40°C), 10 years (25°C)			
	Replacement by user		Yes (Hot swapping)			
	Auto battery check function		Yes			
	Battery life counter function		Yes			
	Charging time		4 hours *7			
Backup time (25°C, initial characteristics)		6 min. (120 W)	6 min. (240 W)	6 min. (360 W)	6 min. (480 W)	
Environment	Operating ambient temperature/humidity		0 to +55°C/10 to 90% (with no condensation)			
	Storage ambient temperature/humidity		-20°to +55°C/10 to 90% (with no condensation)			
	Vibration resistance		JIS C 60068-2-6 compliant. 5 to 8.4 Hz amplitude: 3.5 mm, 8.4 to 150 Hz acceleration rate: 9.8 m/s ² X, Y, and Z directions for 100 minutes (Time coefficient: 10 minutes × coefficient factor 10 = total time 100 min.)			
	Shock resistance		JIS C 60068-2-27 compliant. 147 m/s ² , 3 times in X, Y, and Z directions.			
Structure	Dimensions (W × D × H mm)		94 × 100 × 100	148 × 100 × 100	270 × 100 × 100	
	Weight of unit		Approx. 0.8 kg	Approx. 1.3 kg	Approx. 2.0 kg	Approx. 2.3 kg
	Cooling method		Natural cooling			
Insulation and withstand voltage	Withstand voltage		1,000 V 50/60 Hz AC between the DC external terminals and the GR terminal for 1 minute at a leakage current of 10 mA max.			
	Insulation resistance		20 MΩ min. between the DC external terminals and the GR terminal (at 500 VDC)			
Compliance to standard	Safety standard		UL508/CE/UKCA/C22.2 No.107.1-01			
	EMI	Radiated disturbance electromagnetic field strength	EN61000-6-4/FCC/ICES/RCM/KC			
	Ship standard		LR/ABS/DNV/EN60945 *8			
Internal power consumption (normal *2 / maximum *3)		7 W/22 W	11 W/41 W	14 W/60 W	18 W/80 W	
Serial communication	RS-232C (Interface terminal)		Yes (RJ45)			
	USB (interface terminal)		Yes (B connector)			
I/O signal (Interface terminal)		Yes (RJ45)				
Accessories		USB cable (1.5 m)				
Accessory functions		Beeper setting; Auto restart setting; Auto test setting; Auto restart mode setting; Input sensitivity setting; Remote ON/OFF signal logic setting; Cold start setting; Battery life counter setting; Power switch function setting; Maximum backup time setting; Startup battery level setting; Backup stop (BS) signal delay time setting; Backup (BU) signal delay time setting; and Contact signal I/O test				

*1. An estimated value for standard mounting. Not a guaranteed value.

*2. Conditions: With rated loads connected, at a rated input voltage, and with the battery fully charged.

*3. Conditions: With rated loads connected, at a rated input voltage, and at the maximum battery charging current.

*4. 400 W for use as a UL compliant device.

*5. 20 A for use as a UL compliant device.

*6. 16.7 A for use as a UL compliant device.

*7. When using in an environment at a high temperature, charging may be paused by charging temperature protection, then the charging time will be longer than specified time.

"CS" will be displayed when charging temperature protection is operated.

*8. For the S8BA-24D24D120LF, install all of the RSMN-2030, RSHN-2030, and RSEN-2030 EMC filters manufactured by TDK. For the S8BA-24D24D240LF, S8BA-24D24D360LF, or S8BA-24D24D480LF, install both the RSMN-2030 and RSHN-2030 or their equivalents. Install these filters in series to the cable connected to the DC input terminal block.

When you do, do not connect anything to the GR terminal.

The effectiveness of the noise filters may be affected by the installation environment. Be sure to check effectiveness before starting operation.

Nomenclature

Front view

S8BA-24D24D120LF (120 W)

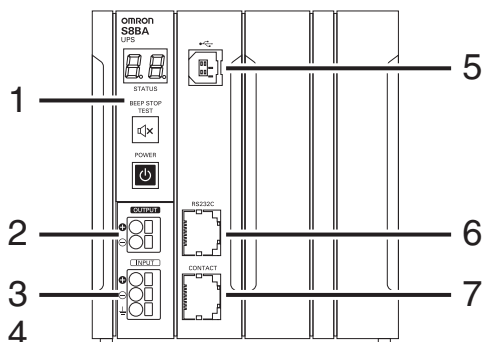

Enlarged view of the operation panel

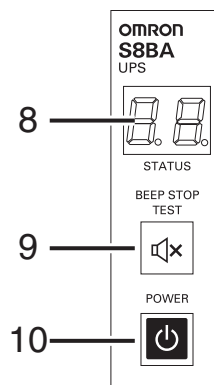

S8BA-24D24D240LF (240 W)

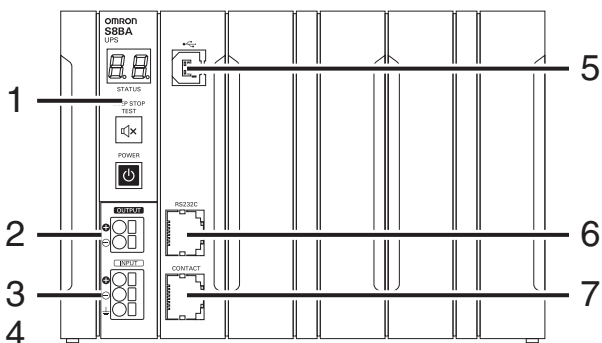

S8BA-24D24D360LF (360 W)

S8BA-24D24D480LF (480 W)

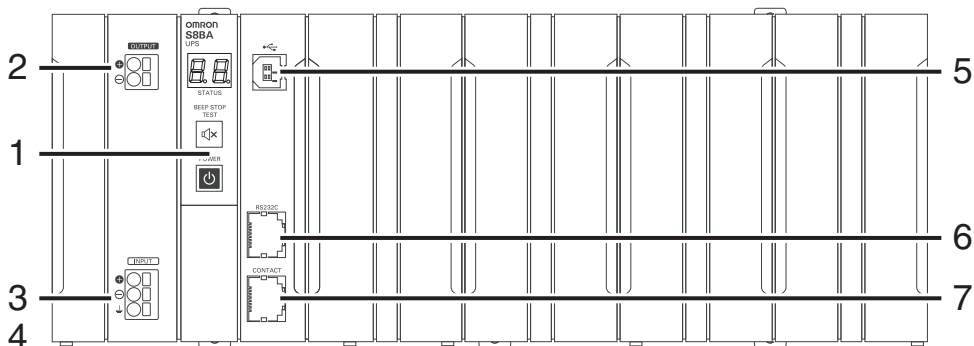

No.	Name	Function
1	Operation panel	Describe the name of each part.
2	DC output terminal block	Connect to load lines. (+V), (-V)
3	DC input terminal block	Connect to input lines. (+V), (-V)
4	GR terminal for communication cable shield \perp	Ground this terminal to less than 100 Ω to improve noise resistance and prevent electrical shock.
5	USB port	Connect to a USB cable.
6	RS-232C port	Connect to a RS-232C cable.
7	CONTACT port	I/O port. Connect to a signal line.
8	“Status indicator” digital indicator	The seven-segment display indicates the status of the UPS.
9	“Beep Stop/Test” switch	Stop the beeper and perform self-diagnosis testing.
10	“Power” switch	Turn the power of the UPS ON/OFF.

S8BA-LF

Rear view

S8BA-24D24D120LF (120 W)

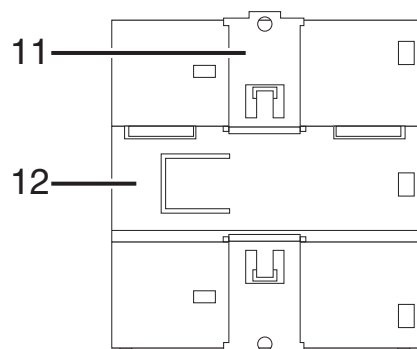

S8BA-24D24D240LF (240 W)

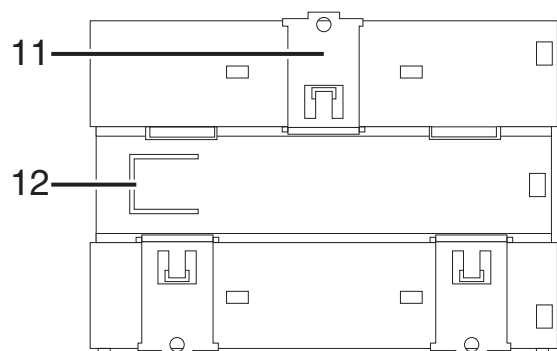

S8BA-24D24D360LF (360 W)

S8BA-24D24D480LF (480 W)

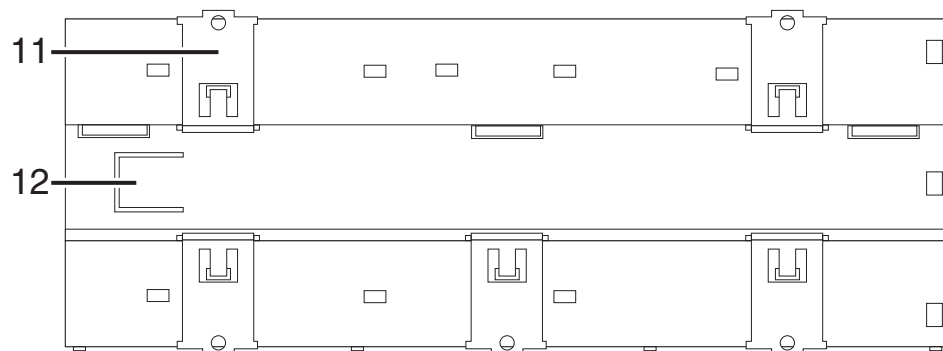

No.	Name	Function
11	DIN rail mounting hook	Hook the UPS on the DIN rail.
12	DIN rail mounting groove	Groove for positioning the DIN rail and the UPS.

Connections

Block Diagrams

S8BA-24D24D□□□LF

Diagram of the Input/output circuit block

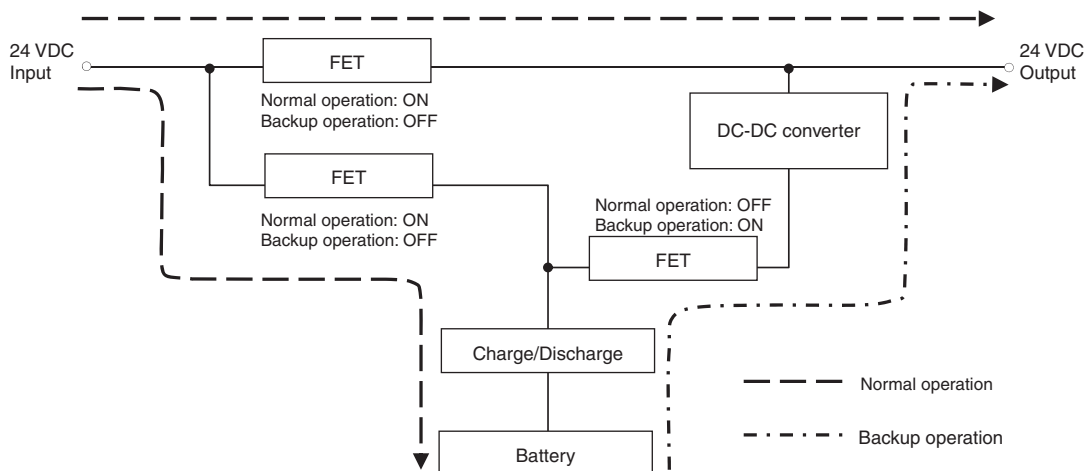

* In normal operation, 24 VDC is output as-is for charging the battery and from the input power supply. If 24 VDC from the input power supply drops, the operation automatically switches to backup operation, and 24 VDC is output from the battery.

Input and output voltage time chart when shifting to backup operation

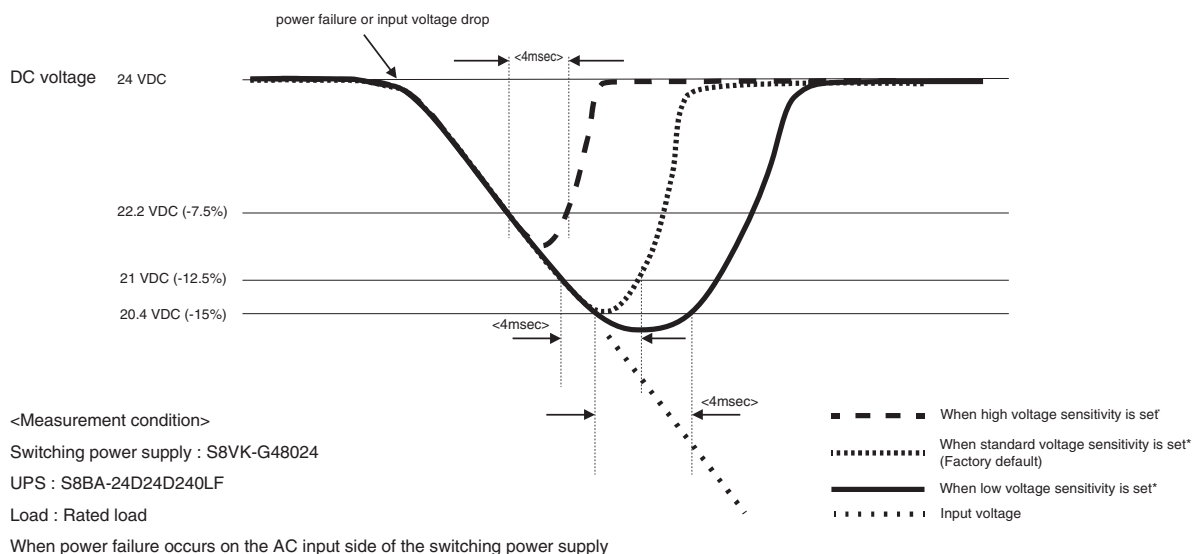

Connecting a cable to Battery connection terminal block, the input terminal block and the output terminal block

For details about the connectable sizes and recommended cable sizes, see the following table.

Connectable size	Cable	Solid wire	0.2 to 4.0 mm ²
		Twisted pair	0.2 to 2.5 mm ²
		AWG	AWG24 to 12
Stripped cable length			8 to 10 mm
Recommended cable size	5 A	Solid wire/Twisted pair	0.5 mm ²
		AWG	AWG20
	10 A	Solid wire/Twisted pair	1.25 mm ²
		AWG	AWG16
	15 A	Solid wire/Twisted pair	2.0 mm ²
		AWG	AWG14
20 A	Solid wire/Twisted pair	3.5 mm ²	
	AWG	AWG12	
Temperature rating for recommended cable			90°C

I/O signal functions

Type of output signals

Signal	Description
Backup signal output (BU)	Stays ON during backup operation at a power failure.
Low battery level signal output (BL)	Goes ON when the battery becomes weak during backup operation at a power failure.
Trouble signal output (TR)	Goes ON when an internal failure of the UPS occurs or when the battery life counter expires.
Battery replacement signal output (WB)	Goes ON when the test determines that battery replacement is necessary due to deterioration or when the battery life counter reaches the replacement period. (The life counter operates while input power is being supplied.)

Type of input signals

Signal	Description
Input of the UPS stop signal (BS)	When the BS signal is ON (High), the output of the UPS is stopped after the time period specified in advance has elapsed. *
Remote ON/OFF signal	Remote ON/OFF signals can be used to start and stop the UPS, by using either an externally connected contact or the ON/OFF status of the open collector circuit. When signal is OFF, the UPS will be turned on. When signal is ON, the UPS will be turned off. In the factory settings, the UPS stops operation when this is short-circuited. In addition, it is necessary to turn on the "Power" switch of UPS to use this function.

* BS signal delay time

It is possible to set the period of time from when a BS signal is received until the output of the UPS is stopped. The output of the UPS can be stopped by inputting the voltage signal (High).

I/O signal port (RJ45 connector)

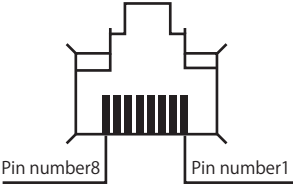
Appearance of the port	Pin number	Item
	1	Backup signal output (BU)
	2	Remote ON/OFF input (-)
	3	Trouble signal output (TR)
	4	COMMON (COM)
	5	Battery LOW signal output (BL)
	6	Backup stop signal input (BS)
	7	Battery Replacement Signal output (WB)
	8	Remote ON/OFF input (+)

Contact signal ratings

Signal	Description
Signal output (BL, TR, BU, WB)	<ul style="list-style-type: none"> Applicable voltage: 50 VDC or less Maximum current: 360 mA BU signal min. response time: 10 ms
Remote ON/OFF	<ul style="list-style-type: none"> Voltage between terminals: 5 VDC Current when closed: 10 mA max. Min. signal response time: When stopped 100 ms When restarting 300 ms
UPS Stop Signal input (BS)	<ul style="list-style-type: none"> Input voltage: HIGH (ON) 8 to 24 VDC LOW (OFF) 0.5 VDC or less Input current: 1.7 to 5.1 mA Min. signal response time: When stopped 100 ms When restarting 300 ms

Contact signal circuit

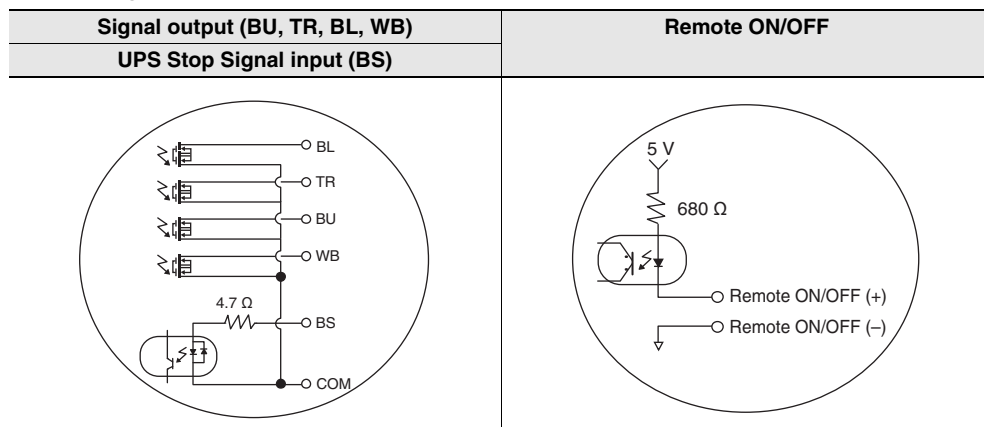

Precautions when selecting switch mode power supplies

When selecting switch mode power supplies, install devices with a capacity larger than the total of the UPS internal power consumption and internal power consumption of connected devices to the input side of the UPS. When these conditions are met, usage will be possible with no problems even if the rated capacity of the UPS is larger than the rated capacity of the switching power supply.

Switch mode power supply capacity > (UPS internal power consumption + Internal power consumption of connected devices)

(Ex.)

$$\text{Switch mode power supply (Capacity: 92 W or more)} > \left(\text{UPS (Internal power consumption: 22 W)} + \text{Industrial-purpose computers (IPC)/controllers, etc. (Internal power consumption: 70 W, DC input)} \right)$$



S8BA
(Capacity: 120 W)

S8BA-LF

Engineering Data

Estimated backup time

The backup time varies depending on the capacity of connected devices.

After calculating the total capacity of connected devices, refer to the graph of the backup time to obtain an estimation of the initial value of the backup time. (This is also applied to checking the battery.)

1. Convert the total capacity (power consumption) of the connected devices to watts (W).

For the indication of connected devices, check your computer and the rear of the display.

The indicator can show values in two different ways: amperes (A), and watts (W).

Example 1: 24 VDC, 145 W

Example 2: 24 VDC, 1.8 A

Indication	Value
A	$W = A \times 24$

For devices that use the A indication, convert the capacity into W.

Example 2: 1.8 (A) = 1.8×24 (W) = 43.2 (W)

2. Add the values converted into W to obtain the total capacity of the connected devices.

3. Calculate the initial value of the backup time for the total capacity of the connected devices from the graph below.

- Graph of backup time (graph of initial values for products that have not been used at 25°C). The backup time becomes shorter than the graph (table) below when temperature is lower.

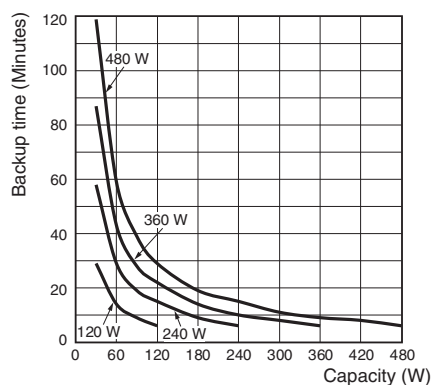

- The smaller the capacity of connected devices becomes, the longer the backup time becomes.

Backup time table

(Time unit: minutes)

	Capacity (W)									
	30	60	90	120	180	240	300	360	420	480
S8BA-24D24D120LF (120 W)	29	14	9	6	—	—	—	—	—	—
S8BA-24D24D240LF (240 W)	58	29	19	15	9	6	—	—	—	—
S8BA-24D24D360LF (360 W)	87	43	28	22	14	10	8	6	—	—
S8BA-24D24D480LF (480 W)	119	59	39	29	19	15	11	9	8	6

Note: The above backup times are for reference only. They may change depending on the battery life and external environment (such as temperature).

Derating curve

120, 240 W
 <S8BA-24D24D120LF>
 <S8BA-24D24D240LF>

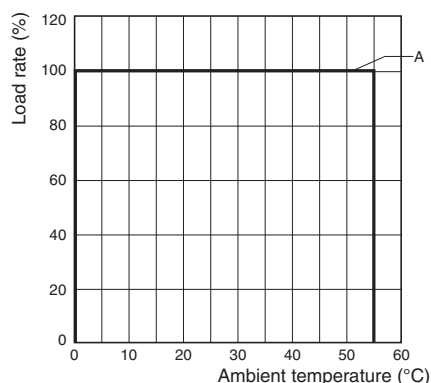

A: For standard mounting, face-up mounting, stationary mounting

360 W
 <S8BA-24D24D360LF>

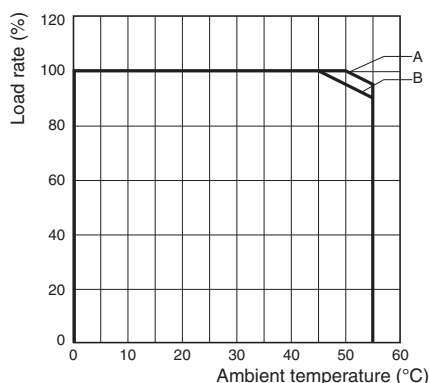

A: For standard mounting,
 B: For face-up mounting, stationary mounting

480 W
 <S8BA-24D24D480LF>

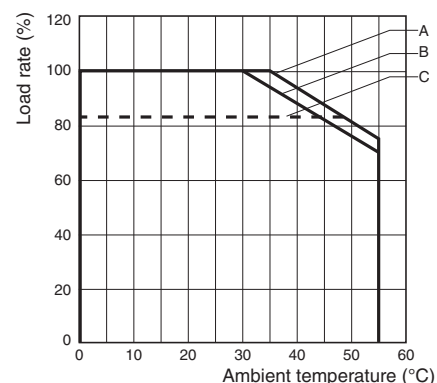

A: For standard mounting,
 B: For face-up mounting, stationary mounting
 C: For standard mounting (For use as a UL compliant device)

Backup operation sequence in the event of power failure/voltage drop (instantaneous voltage drop)
 When the input power supply recovers while the battery level is sufficiently high

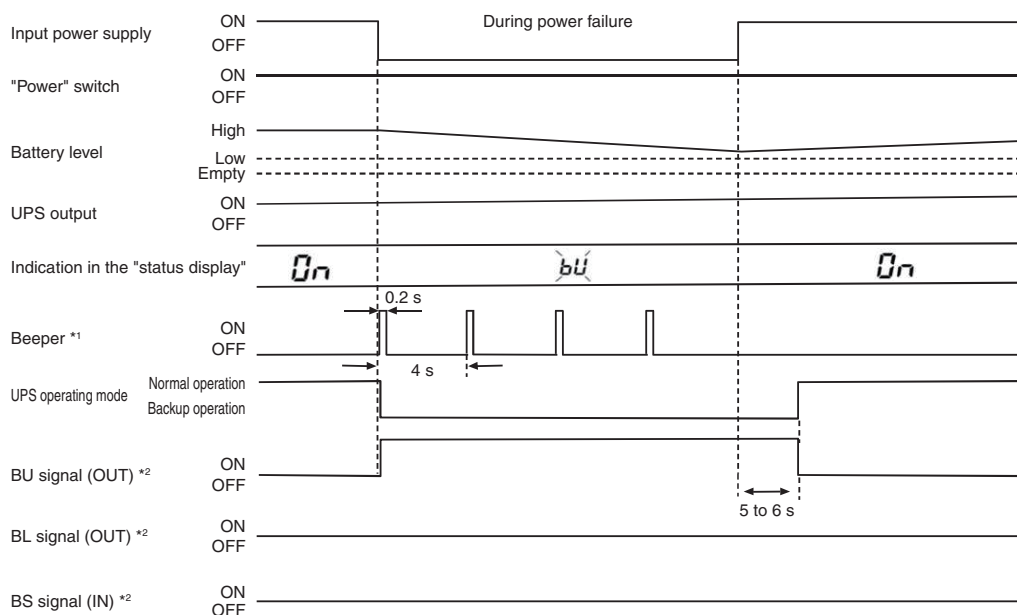

*1. "Disable beeper" is set by factory default. When "Disable beeper" is set, the buzzer does not sound during backup operation. For details, refer to 4-4 UPS operation mode settings.
 *2. For details, refer to 7-1 I/O signal functions.

When the input power supply recovers while the battery level is Low

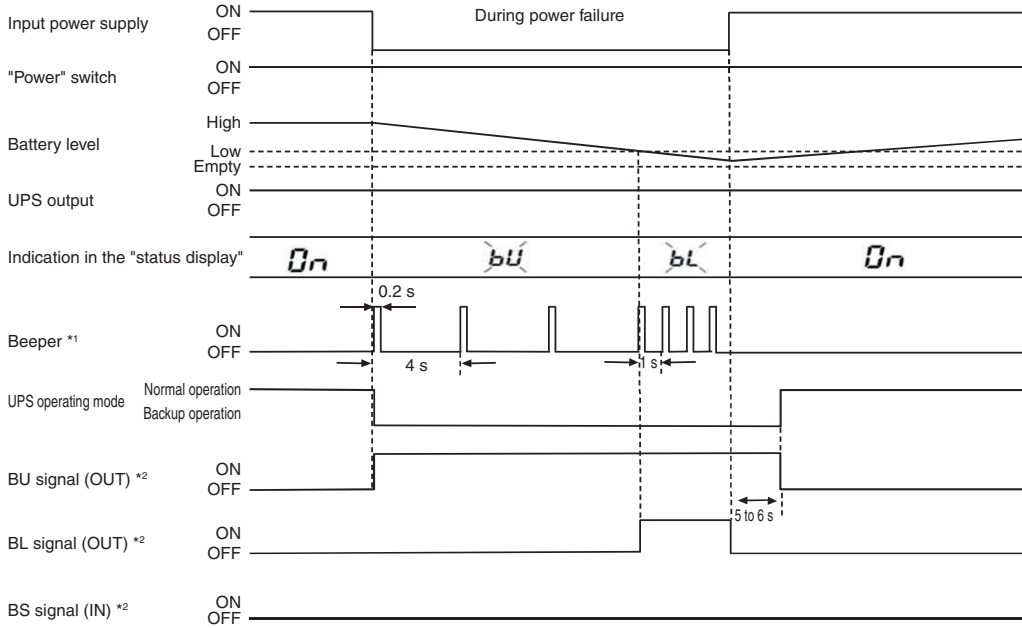

*1. "Disable beeper" is set by factory default. When "Disable beeper" is set, the buzzer does not sound during backup operation. For details, refer to 4-4 UPS operation mode settings.
 *2. For details, refer to 7-1 I/O signal functions.

When the input power supply does not recover until the battery becomes empty

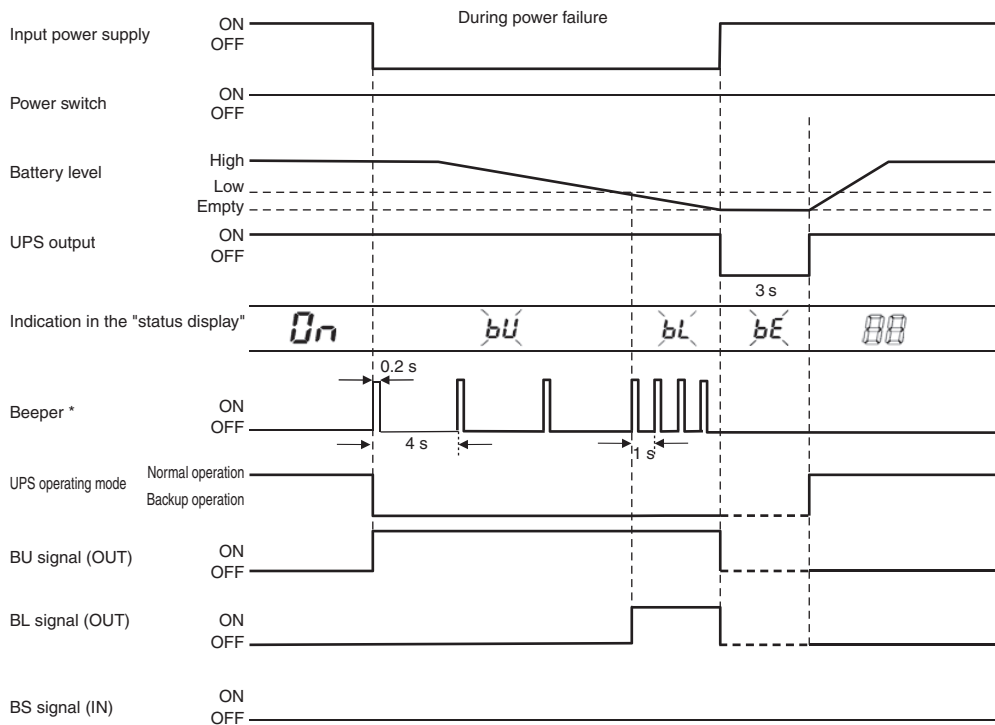

* "Disable beeper" is set by factory default. Even when "Disable beeper" is set, the buzzer sounds at startup.

Overcurrent protection curve

120W, 240W, 360W, 480W

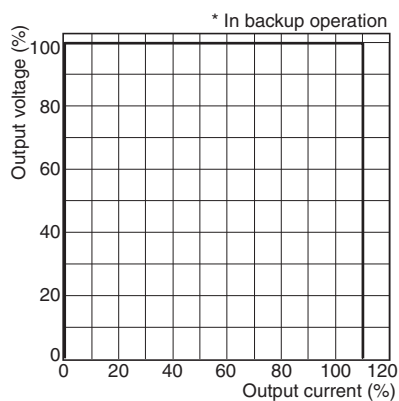

Note: 1. In backup operation, the output voltage drops at a load rate of 110% or higher.
 2. In normal operation, the output stops when the input protection fuse blows out.

Dimensions

(Unit: mm)

Main body

S8BA-24D24D120LF (120 W)

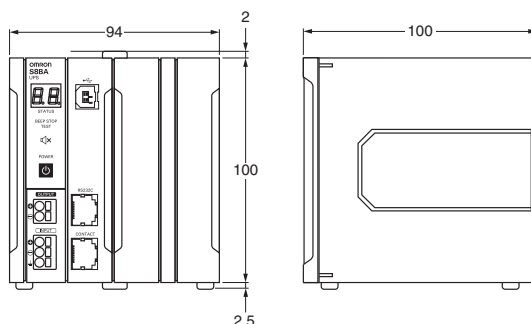

S8BA-24D24D240LF (240 W)

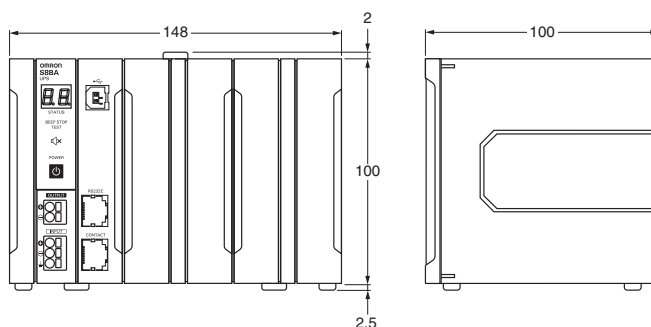

S8BA-24D24D360LF (360 W)
 S8BA-24D24D480LF (480 W)

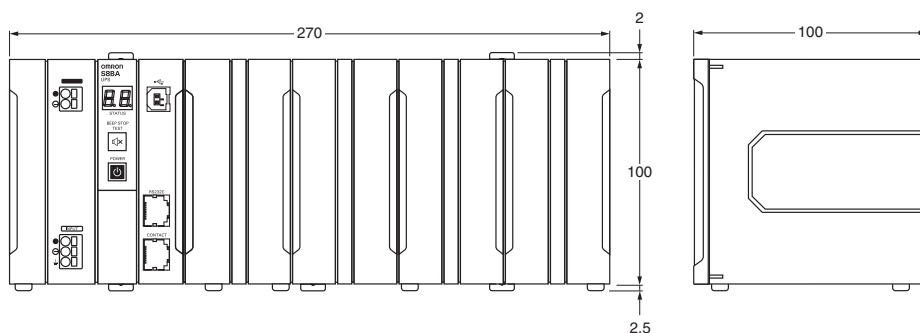

DIN Rail (Order Separately)

Mounting Rail (Material: Aluminum)

PFP-100N
PFP-50N

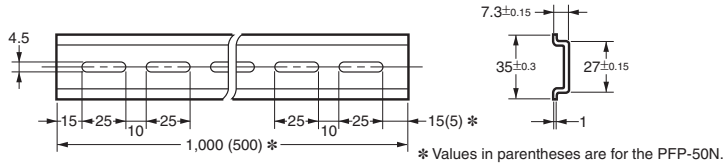
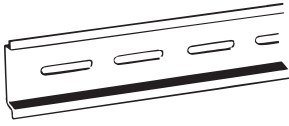

Mounting Rail (Material: Aluminum)

PFP-100N2

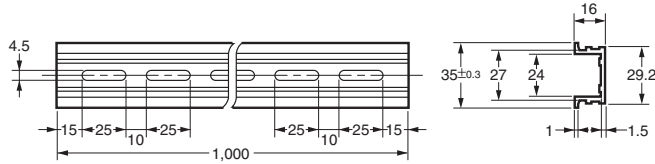
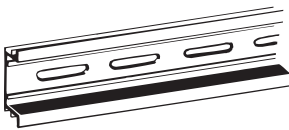

End Plate

PFP-M

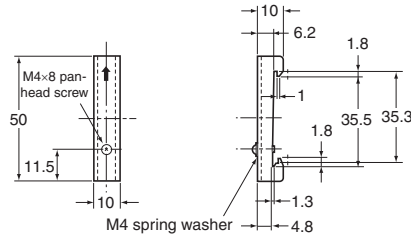
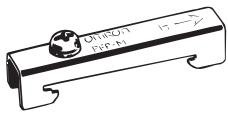

- Note:**
1. If there is a possibility that the Unit will be subject to vibration or shock, use a steel DIN Rail. Otherwise, metallic filings may result from aluminum abrasion.
 2. If the Unit may be subjected to sliding to either side, attach an End Plate (model PFP-M) on each side of the Unit.



Power management solutions

The following software is available as a free download from our website.







Name	Description	Conditions	Interface
Power Attendant Lite	<ul style="list-style-type: none"> You can execute computer shutdown and UPS auto stop when an input power problem occurs (power failure, etc.). You can use a computer that has "Power Attendant Lite" installed to send a script over the network to devices that do not have shutdown software installed to log in to each device and execute a device shutdown command. You can automatically start and stop computers and the UPS according to a preset schedule. 	<For Windows> Windows 11/10/8.1/8 Windows Server 2022/2019/10T 2019 for Storage/2016/2012 R2/2012 Windows Storage Server 2016/2012 R2/2012 Windows 10 IoT Enterprise LTSC Windows Embedded Standard 7 <For Linux> Red Hat Enterprise Linux 8.5/8.4/8.3/8.2/8.1/8.0/7.9/7.8/7.7/7.6/7.5/7.4/7.3/7.2/7.1/7.0 CentOS 8.4/8.3/8.2/8.1/8.0/7.9/7.8/7.7/7.6/7.5/7.4/7.3/7.2/7.1/7.0	RS232C USB
Simple Shutdown Software	<ul style="list-style-type: none"> You can execute computer shutdown and UPS auto stop when an input power problem occurs (power failure, etc.). You can modify and recompile the source code to incorporate a UPS management function into your Windows/Linux® system. Supports Windows and Linux 	<For Windows> Windows 11/10/8.1/8 Windows Server 2022/2019/2016/2012 R2/2012 Windows 10 IoT Enterprise LTSC Windows Embedded Standard 7 <For Linux> Red Hat Enterprise Linux 8.5/8.4/8.3/8.2/8.1/8.0/7.9/7.8/7.7/7.6/7.5/7.4/7.3/7.2/7.1/7.0 CentOS 7.9/7.8/7.7/7.6/7.5/7.4/7.3/7.2/7.1/7.0	RS232C USB
Setting Utility	This software is used to configure UPS settings. (Setting item examples) Function for sending commands Function for saving settings to a backup file Function for restoring settings from a backup file Function for reading UPS settings Function for returning UPS settings to default settings	Windows 11/10/8.1/8 Windows Server 2022/2019/2016/2012 R2/2012 Windows 10 IoT Enterprise LTSC Windows Embedded Standard 7	RS232C USB

Safety Precautions

Warning Indications

 Warning	Indicates a potentially hazardous situation that, if not avoided, could result in serious injury or death. Additionally there may be significant property damage.
 Caution	Indicates a potentially hazardous situation that, if not avoided, could result in minor or moderate injury or property damage.
Precautions for Safe Use	Supplementary comments on what to do or avoid doing to use the product safely.
Precautions for Correct Use	Supplementary comments on what to do or avoid doing to prevent failure to operate, malfunction, or undesirable effects on product performance.

Meaning of Product Safety Symbols

	General inhibition Notice prohibiting an unspecified general action.
	General instruction Notice instructing an unspecified general action.
	Do-not-disassemble prohibition Notice prohibiting disassembly because disassembling the device may cause such an accident as an electric shock.
	Prohibition of use in locations subject to water such as a bathroom and shower room Notice prohibiting installation of the device in locations subject to water, because if a device not made water-proof is used in such locations, injury may occur due to an electric leak.
	Do-not-touch prohibition Indicates the possibility of injuries by touching the specific portion of the device under specific conditions, prohibiting touching of the device.
	Explosion alert Notice alerting the user to the possibility of explosion under certain conditions.

WARNING

(for use of this product)

- Provide safety measures in external circuits, not in the UPS, in order to ensure safety in the system if an abnormality occurs due to malfunction of the UPS or another external factor affecting the UPS operation. Not doing so may result in serious accidents.



(When replacing the battery unit)

Dispose of or collect (recycle) the battery unit according to your own rules set for that purpose or as instructed by laws and regulations.

- Do not dispose of it in fire. Otherwise, it could explode.



廢電池請回收

Caution

(for installation and connection)

Carry the unit considering its weight and balance, and place it on a stable and robust base.

- If you drop the unit, the battery or the battery protection mechanism may be broken, and it may result eventually in a fluid leak, abnormal heating, smoke, rupture or fire.
- If you drop the unit, stop using it and have it inspected and repaired.
For details on repair, contact the OMRON representative.



Keep plastic package bags out of reach of children.

- Children may suffocate if they place their heads into plastic bags.



Make sure to connect the “input power supply” to the direct power supply equipment with a rated voltage (24 VDC).

- The input voltage ranges for the UPS are as shown below. Check that the output voltage of the direct power supply equipment connected to the input terminal of the UPS is within any of the voltage ranges below.
 - 24 VDC±10% (Input voltage range: When standard voltage sensitivity is set)
 - 24 VDC±12.5% (Input voltage range: When low voltage sensitivity is set)
 - 24 VDC±5% (Input voltage range: When high voltage sensitivity is set)
- Connecting to a DC or AC power supply device with a different voltage may result in malfunction in or damage to the UPS, or cause a fire.



When an abnormality (unusual sound or smell) occurs, turn OFF the unit’s “Power” switch to stop the output, and stop the supply of commercial power.

- When performing maintenance on the connected devices, follow the above instructions to ensure safety.



When installing the input cable, make sure to perform the connection as specified.

Make sure to stop the primary power supply before connecting the unit to the input power supply terminal.

- When connecting a cable to the terminal block, use a cable that complies with the input current specification of the UPS. Failure to do so may result in electric shock or ground fault.



Do not disassemble, repair, or modify the unit.

- Doing so may cause an electric shock or a fire.



Do not install the unit in other than specified orientations.

- Dropping or toppling the unit may cause injury.
- If the UPS is not installed in the specified direction, the internal temperature may rise, eventually damaging the UPS or deteriorating the battery.



Do not use the unit where the maximum temperature exceeds 55°C.

- The battery deteriorates rapidly. It may result in fire.
- If the battery’s resin separator is damaged, the battery may be short-circuited inside, and may cause an abnormal heating, smoke, rupture or fire.
- Doing so may cause a failure or malfunction of the unit.



Do not exceed the ranges specified for environmental conditions during use/storage.

Do not install or store the unit in the places listed below.

- Do not store in places where the humidity is lower than 10% or higher than 90%.
- Do not use the unit in places where the ambient temperature is lower than 0°C or higher than 55°C. (With no condensation)
- Do not use in places where the humidity is lower than 10% or higher than 90%.
- Do not install/store the unit in closed places such as cabinets with no clearance, places where there is flammable or corrosive gas,
- Places with large amounts of dust, places exposed to direct sunlight, places exposed to shock or vibration, salty or wet places, or outdoors.
- Installation or storing the unit in such a place may cause a fire.



When you use plug strip and other plugs to connect additional devices, do not connect devices that exceed the current capacity of the available plugs.

- The current protection of the unit may operate, which may stop the output.
- The cable heats up, which may cause a fire.



Do not pinch or sharply bend the cable.

Do not fold or knot the cable.

- Doing so may cause the cable to be damaged or heated, which may cause an electric shock or a fire.
- If the cable is damaged, stop using the unit and have the cable repaired.
- For details on repair, contact our sales personnel.



Connect only devices using 24 VDC rated voltage.

- The rated output voltage of the UPS is 24 VDC.
- Overvoltage or overcurrent may damage the connected devices.



All the accessories contained in the product package can be used for the UPS only. Do not use any of them for other devices.

- Be sure to observe this to use the UPS safely.



Include a breaker between the "input power supply" of the UPS and the direct power supply equipment. And, install the breaker where it is easy to operate.



To use this product as CE/UKCA marking compliant device, use a 2-meter or shorter connection cable.



Do not block the air vents (upper and lower).

- Doing so will cause the internal temperature to rise, which may cause the unit to fail and the battery to deteriorate.
- For stationary installation, leave a space of 50 mm or more above the top, and for installation using a DIN rail and screw clamps, leave a space of 50 mm or more above the top and below the bottom each.



Do not connect the RS-232C port or the CONTACT port to a LAN device.

- Connection to a LAN device may result in malfunction in or damage to the UPS or the LAN device.



Do not remove the dust cover for ports that are not in use (RS-232C, CONTACT).

- If the RS-232C and CONTACT port are incorrectly connected, it may cause smoke or fire.



Do not connect the unit in parallel.

- Connecting the unit in parallel may result in malfunction or in damage to the unit.



(for use)

Do not allow the unit to come in contact with water. If you drop the unit, stop using it.

- Doing so may cause an electric shock or a fire.
- Doing so may cause an abnormal heating, smoke, rupture, or fire on the battery.
- If the unit becomes wet or is dropped, immediately stop using it, disconnect the input power supply from the wall outlet (commercial power source) and have it inspected and repaired.
- For details on repair, contact our sales personnel.



When the battery is dead, replace it immediately or stop using the unit.

- Continuing the use of it may cause fire or electric shock due to liquid leaks.



Ambient temperature	Expected life
50°C	2.5 years
40°C	5 years
25°C	10 years

* The values in the table are the expected life under standard use conditions and are not guaranteed.

Occasionally, wipe off dust on the input terminal block and the output terminal block with a dry cloth.

- Accumulated dust may cause a fire.
- Before wiping off dust, stop all connected devices and the unit, and stop the supply of commercial power.



Do not use the unit in a closed place and do not cover the unit.

- Doing so may cause abnormal heating or a fire.



If you notice something unusual such as abnormal sound or smell, discoloration, deformation, and heating, turn OFF the unit's "Power" switch to stop the output and stop the supply from the "input power supply".

- Using the unit under such conditions may cause an abnormal heating, rupture or fire.
- If this situation arises, be sure to stop using the UPS and request our sales personnel for inspection and repair.
- A readily accessible disconnect device shall be incorporated external to the equipment.



If fluid leaks from the interior, do not touch the fluid.

- Doing so may cause blindness or burns.
- If the fluid contacts your eyes or skin, wash it out with lots of clean water and consult your doctor. The fluid may damage your eye if your eye is left untreated.



Do not place any objects on the unit, and do not drop heavy objects onto the unit.

- Doing so may cause distortion/damage to the case or a failure of the internal circuit, which may cause a fire.



The unit is equipped with a bypass circuit which is able to supply electric power to connected devices even when the inner control circuit is broken down by defects or malfunctions.

If you want to stop the output, stop the source of the "input power supply".

- Output is continuing even when all indicators of the front panel are off.
- Output ON/OFF cannot be controlled with the "Power" switch on the front panel.



When charging the battery, if the battery cannot be charged completely even after the predetermined charging time, turn OFF the "Power" switch of the unit to stop charging the battery.

- Otherwise, it may cause an abnormal heating, smoke, rupture or fire on the battery.



(for maintenance)

When maintaining the connected equipment, turn OFF the unit's "Power" switch to stop the output, and stop the supply of the "input power supply".



- Even if the input power supply to the UPS is stopped while it is in operation, the power output of his unit does not stop and power is supplied from the battery.

Do not disassemble, repair, or modify the unit.

- Doing so may cause an electric shock or a fire.



If fluid leaks from the interior, do not touch the fluid.

- Doing so may cause blindness or burns.
- If the fluid contacts your eyes or skin, wash it out with lots of clean water and consult your doctor.



Do not throw the unit into fire.

- Since the battery is incorporated in the unit, the insulator may melt, the gas exhaust valve or protection mechanism may be damaged, or the electrolyte may catch fire, and it may result eventually in an abnormal heating, smoke, rupture or fire.



Do not insert metal objects into the input terminal block and the output terminal block of the UPS.

- Doing so may result in electric shock.



Do not insert metal objects into the battery connectors. Do not short between the connector terminals.

- Doing so may result in electric shock.
- The battery's protection board may be damaged due to a short-circuit.

**(for battery replacement)**

Risk of explosion if battery is replaced by an incorrect type.

- Not doing so may cause a fire.
- Battery pack for; product model: S8BA-B120L.



Do not replace the battery in a place where there is flammable gas.

- Spark may occur when connecting the battery, which may cause an explosion or fire.



If fluid leaks from the battery, do not touch the fluid.

- Doing so may cause blindness or burns.
- If the fluid contacts your eyes or skin, wash it out with lots of clean water and consult your doctor.



Do not disassemble or modify the battery.

- A safety mechanism and protection mechanism to prevent danger are embedded into the battery. If they are damaged, it may cause an abnormal heating, smoke, rupture or fire on the battery.



Do not drop the battery and do not expose it to strong impact.

- Doing so may cause a leakage, abnormal heating, smoke, rupture or fire on the battery. And, if the battery's protection mechanism is broken, the battery may be charged at an abnormal current or voltage, an abnormal chemical reaction may occur inside the battery, and it may result eventually in an abnormal heating, smoke, rupture or fire.



Do not short the battery with metal objects.

- Doing so could cause an electric shock, fire or burn.
- Some electrical energy still remains inside the spent battery.



Do not dispose of battery in a fire or damage battery.

- The insulator inside the battery may melt, the gas exhaust valve or protection mechanism may be damaged, or the electrolyte may catch fire, and it may result eventually in abnormal heating, smoke, rupture or fire.



Do not use a new battery and an old battery at the same time.

- The battery may be excessively discharged while being used or excessively charged while being charged, an abnormal chemical reaction may occur inside the battery, and it may result eventually in an abnormal heating, smoke, rupture or fire.
- A battery can present a risk of electrical shock and high short circuit current.
- Contact with any part of a grounded battery can result in electrical shock.
- The following precautions should be observed when working on batteries:
 - (a) Remove watches, rings, or other metal objects.
 - (b) Use screwdrivers with insulated handles.
 - (c) Wear rubber gloves and boots.
 - (d) Do not lay tools or metal parts on top of batteries.
 - (e) Remove the connection from ground if any part of the battery is determined to be grounded.



Dispose of or collect (recycle) the battery according to your own rules set for that purpose or as instructed by laws and regulations.



Do not dispose of it in fire. Otherwise, it could explode.

廢電池請回收

**Precautions for Safe Use****Before using**

Charge the battery soon after purchasing the unit.

- If not used for a long time after being purchased, the UPS may become unusable because the characteristics of its battery become inferior.
- Connect the UPS to the input power supply and turn ON the "Power" switch to charge the battery.

If the UPS is moved from a warm place to a cold place, start using it after leaving it as-is for a few hours.

- If the UPS is suddenly moved to a warm place, water may adhere to it (condensation). In such a case, if power is supplied without checking the condition, the UPS may be damaged.
- Take measures against the unexpected events such as protecting data and making the system redundant.
- The UPS may stop its power due to failure.

For Connection

Do not short the output lines of the unit to each other, and do not short positive side of the output lines to the ground.

- Otherwise, the UPS may be damaged.

To transfer or sell the UPS to a third party, attach all the documents and other accessories contained in the product package to the UPS. It is supposed that the UPS is to be used in accordance with the conditions specified in the attached documents.

While Using the UPS

Turn OFF the "Power" switch of the UPS before turning OFF the input power supply.

- When the input power supply is stopped, backup operation starts.
- If the frequency of backup operation becomes high, the battery life may be significantly reduced.

Do not use the UPS for purposes requiring frequent backup operation.

- The battery will deteriorate and become unable to last for the specified backup time.

For Storage

To store the UPS for a long time, store it in an environment where the ambient temperature is 25°C or lower, and charge the battery once every year for 10 to 15 minutes.

- The battery discharges itself even if it is not used. If the battery is left unused for a long time, it goes into a state of over-discharge. In such a case, the backup time may become shorter, or the battery cannot be used anymore.
- We recommend an environment where the ambient temperature is 25°C or lower to store the UPS for a long time.
- Keep the “Power” switch of the UPS turned OFF during storage.
- Do not install or store the UPS in a location exposed to direct sunlight.
- The built-in battery may deteriorate rapidly due to an increase in temperature and become unusable.

Correct Installation Method

- For installation, to improve the long time reliability of the UPS, pay much attention to heat dissipation. Ensure convection of air around the UPS main body, and use the UPS in an operating condition below the derating curve.
- During machining work for mounting, make sure that no metal scrap goes into the product.
- The heat dissipation of the UPS may become worse depending on how the UPS is mounted; in rare cases, internal components may deteriorate and get damaged. Use the UPS in an operating condition based on the derating curve for each mounting direction.

Standard mounting (Mounting to the DIN rail)

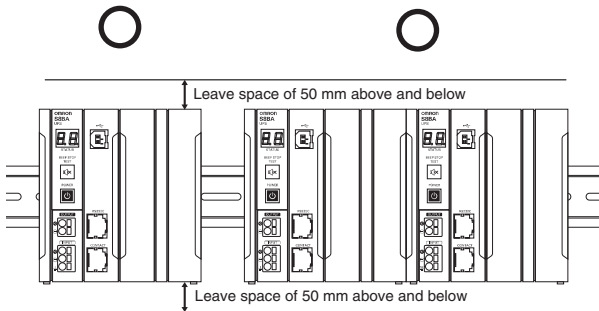

To install devices other than the UPS to both sides, install them by leaving a space specified by each device off the UPS.

Stationary mounting

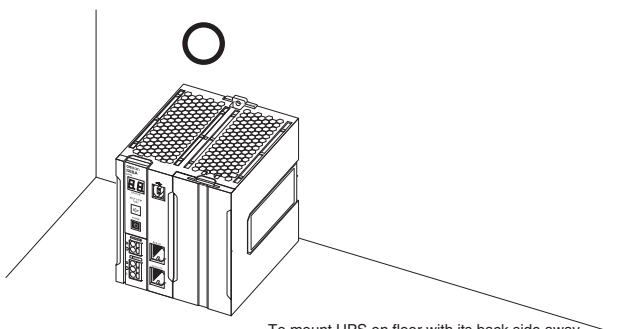

To mount UPS on floor with its back side away from you, mount it so that its back side is in contact with wall. (Because PCB is partially exposed in its back side, and UPS may be affected by static electricity for that reason.)

Face-up mounting

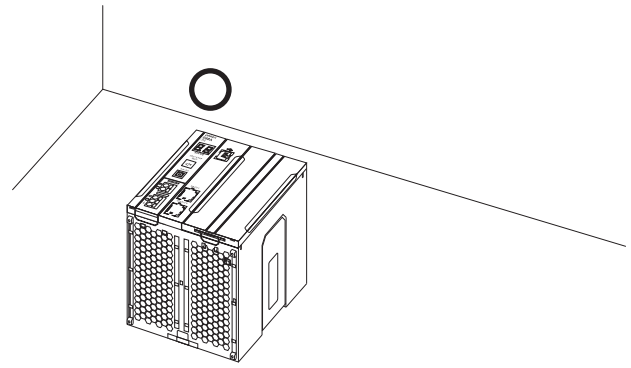

To mount UPS on floor with its top side away from you, mount it so that its top side is 50 mm or more off wall.

Incorrect Installation Method

Mounting to the DIN Track

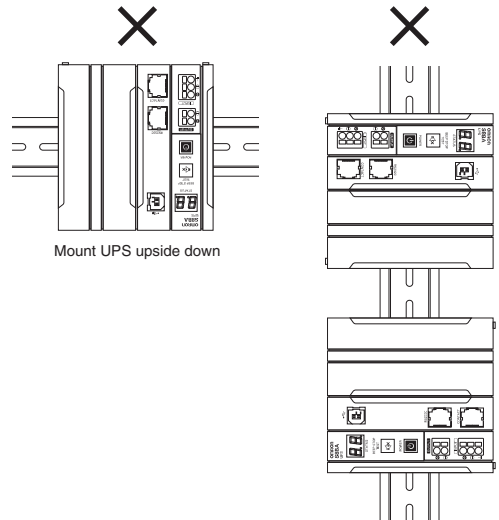

Mount UPS upside down

DIN Track is placed vertically

Stationary installation

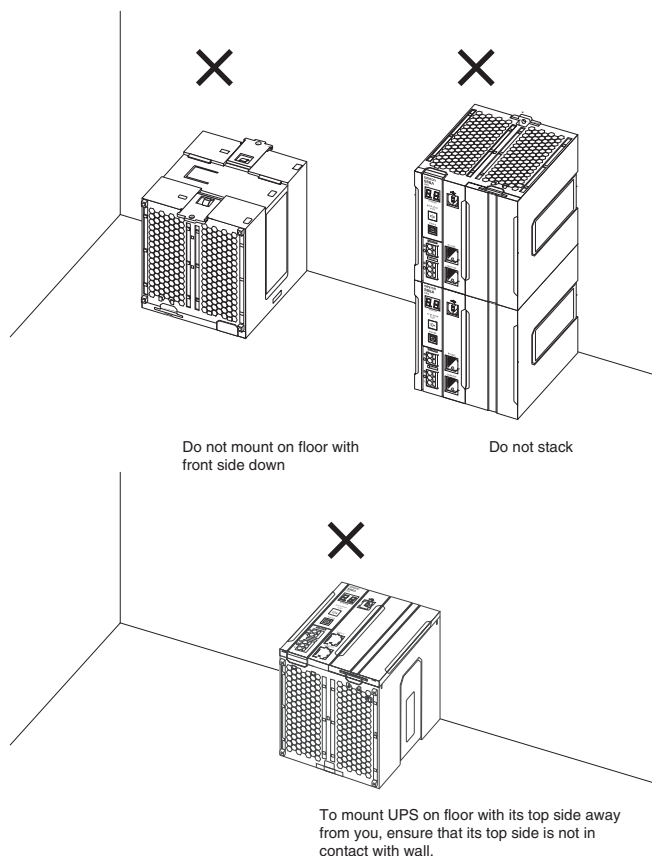

Battery Replacement

The UPS supports hot swapping. Battery replacement is possible both when the power is turned OFF (while the power output is OFF) and when the power is turned ON (while the power output is ON).

Precautions for Correct Use

- For battery replacement, hold down the “Buzzer Pause/Test” switch on the unit for 10 seconds or longer to activate the battery replacement mode. When “b.u.” is displayed, the activation is completed.
 - * Activate the battery replacement mode while the “input power supply” is turned ON. If you replace the battery without activating the battery replacement mode, the battery life may not be detected accurately because the battery life counter is not reset.
- Do not replace the battery during backup operation. Otherwise, the output stops.

The life of the battery used in the UPS is limited. This life changes depending on the use environment and the frequency of backup operation.

- As the battery life comes closer to its end, the battery deteriorates more rapidly. Be careful.

The storage condition also affects the deterioration of the battery. As the storage temperature becomes higher, the battery life becomes shorter. Be careful.

Battery check schedule and frequency

Ambient temperature	6-Month Inspection	3-Month Inspection
55°C	Up to 1 year from the date of purchase	1 year from the date of purchase and afterward
50°C	Up to 1.5 years from the date of purchase	1.5 years from the date of purchase and afterward
40°C	Up to 3 year from the date of purchase	3 years from the date of purchase and afterward
25°C	Up to 6 year from the date of purchase	6 years from the date of purchase and afterward

Conformance to EU Directives and UK Legislations

Applicable directives

- EMC Directives

Principles regarding conformance

OMRON electronic devices conform to the related EMC standards so that they can be more easily built into other devices or the overall machine. The actual products have been checked for conformity to EMC standards*.

Whether the products conform to the standards in the system used by the customer, however, must be checked by the customer. EMC-related performance of the OMRON devices will vary depending on the configuration, wiring, and other conditions of the equipment or control panel on which the OMRON devices are installed. The customer must, therefore, perform the final check to confirm that devices and the overall machine conform to EMC standards.

* Applicable EMC (Electromagnetic Compatibility) standards are as follows: EMS (Electromagnetic Susceptibility): EN 61000-6-2, EMI (Electromagnetic Interference): EN 61000-6-4, and EN 61000-6-4 Radiated emission: 10-m regulations

Conformance to EU Directives and UK Legislations

This product complies with EU Directives and UK Legislations. To ensure that the machine or device in which the this product is used complies with EU Directives and UK Legislations, the product must be installed as follows:

- This product must be installed within a control panel.
- You must use reinforced insulation or double insulation for the direct power supply equipment connected to this product.
- Models of this product conform to the Common Emission Standard. Radiated emission characteristics (10-m regulations), in particular, may vary depending on the configuration of the control panel used, other devices connected to the control panel, wiring, and other conditions. Therefore, even when using a model of this product, you must confirm and ensure the compliance of the entire machine or equipment.
- This is a Class A product (for industrial environments). In a residential environment, it may cause radio interference. If radio interference occurs, the user may be required to take appropriate measures.

Conformance to UL

Conformance to UL

- This product must be installed within a control panel with an internal heater or other unit to protect against the formation of condensation.
- Gaps in the door to the control panel must be completely filled or covered with gaskets or other material.
- For use as a UL compliant device, the specifications for S8BA-24D24D480LF become as follows:
 - Maximum input current: 20 A
 - Rated output current/capacity: 16.7 A/400 W
 - For use in Pollution Degree 2 Environment.
 - Surrounding Air Temperature, 55°C.
 - Make sure to connect the device with Class 2 output to the USB port.

Conformance to FCC

FCC CAUTION

Changes or modifications not expressly approved by the party responsible for compliance could void the user's authority to operate the equipment.

- This equipment has been tested and found to comply with the limits for a Class A digital device, pursuant to part 15 of the FCC Rules. These limits are designed to provide reasonable protection against harmful interference when the equipment is operated in a commercial environment.
- This equipment generates, uses, and can radiate radio frequency energy and, if not installed and used in accordance with the instruction manual, may cause harmful interference to radio communications.
- Operation of this equipment in a residential area is likely to cause harmful interference in which case the user will be required to correct the interference at his own expense.

Conformance to KC

A 급 기기 (업무용 방송통신기자재)

이 기기는 업무용(A 급) 전자파적합기기로서 판매자 또는 사용자는 이 점을 주의하시기 바라며, 가정외의 지역에서 사용하는 것을 목적으로 합니다.

Uninterruptible Power Supply (UPS) Separated battery type S8BA-SBF

DC-DC type small UPS mounts on a DIN rail to provide an ideal countermeasure for momentary power losses and power failures in industrial computers (IPC) and controllers.



- System reliability greatly improved because 24VDC power supply is backed up for a certain period of time in the event of voltage drop or power failure.
- Compactness, weight reduction, and long battery life realized thanks to the adoption of a lithium-ion battery.
- Push-in terminal block adopted for the power input and output I/F.
- Shutdown in conjunction with the industrial purpose computer (IPC) or controller realized by the USB/RS-232C/I/O port installed in the UPS.
- Two types of batteries are selectable for the 480W, allowing the ideal backup time to be realized
- A wide lineup culminating in the 960W makes it possible to provide long-lasting backup for every type of industrial controller

⚠ Refer to *Safety Precautions* on page 33.

Model Number Structure

Model Number Legend * Use the following format to place an order.
The control unit and battery unit are separate, and the battery unit is sold separately.

Control unit part

S8BA- □□□□□□□□□□ SBF

Series name 1 2 3

1. Input voltage specification

Code	Input voltage specification
24D	24 VDC

2. Output voltage

Code	Output voltage
24D	24 VDC

3. Capacity

Code	Capacity
480	480 W
960	960 W

Battery unit part

S8BA- □□□□□ L

Series name 1 2

1. Battery type

Code	Type
S	Separated battery type

3. Terminal block shape

Code	Terminal block shape
480	480 W
960	960 W

S8BA-SBF

Ordering Information

Main body

Uninterruptible Power Supply (UPS) / Control Unit Part

Input voltage	Output voltage	Output current/capacity	Model number
24 VDC	24 VDC	20 A/480 W	S8BA-24D24D480SBF
		40 A/960 W	S8BA-24D24D960SBF

Note: The control unit (960 W) and the battery unit (480 W) cannot be connected.

Battery unit part

Rated voltage	Rated capacity	Weight	Model	UPS Model : Required units
25.2 VDC	3900 mAh	1.5 kg	S8BA-S480L	S8BA-24D24D480SBF
25.2 VDC	7800 mAh	2.5 kg	S8BA-S960L	S8BA-24D24D480SBF
				S8BA-24D24D960SBF

Note: The control unit (960 W) and the battery unit (480 W) cannot be connected.

Communication cable

Specifications	Type	Length	Model number
For RS-232C port	RJ45/Dsub9Pin	2 m	S8BW-C01
For CONTACT port	RJ45/Discrete wire		S8BW-C02

Ratings, Characteristics, and Functions

Description		Capacity	480 W	960 W	
DC input	Rated input voltage		24 VDC		
	Input voltage range		23 to 28 VDC		
	Input maximum current	for rated input voltage for rated loads connected	21.5 A	43.5 A	
	Input terminal		Push-in terminal block		
	Input protection		Fuse (cannot be replaced by the customer)		
	Input protection capacity		30 A	60 A	
DC output	Rated current	for rated output voltage	20 A	40 A	
	Switching time		Uninterrupted		
	Output voltage	Normal operation	Input voltage through output		
		Backup operation	21 to 28 V (the voltage cannot be adjusted)		
	Output terminal		Push-in terminal block		
	Overload protection	Warning display • UPS output will continue through bypass [during normal operation] • UPS output will continue through battery [during backup operation]		101% or more	
		Output stopped by overload protection • Stop output [during normal operation] • The internal power supply to the UPS will stop after 10 sec. [during backup operation]		111% or more	
Warning display cancellation (During normal operation, during backup operation)		93% or more			
Battery unit	Type		Lithium-ion battery		
	Rated voltage		25.2 VDC		
	Rated capacity		3900 mAh	7800 mAh	
	Battery life expectancy *1		10 years (25°C), 6.7 years (35°C), 3.7 years (45°C), 1.9 years (55°C)		
	Replacement by user		Yes (Hot swapping)		
	Battery Life Counter Function		Yes		
	Charging time		8 hours (90%) *3		
	Backup time (25°C, initial characteristics)		6 min. (constant power rated load) The backup time can be set from the mode selection / backup operation time selection switch, or the shutdown software.		
Environment	Operating environment temperature / humidity		0 to +55°C / 10 to 90%RH with no condensation		
	Storage environment temperature / humidity		-20 to +55°C / 10 to 90%RH with no condensation		
	Vibration resistance		JIS C 60068-2-6 compliant 5 to 8.4 Hz amplitude: 3.5 mm, 8.4 to 150 Hz acceleration rate: 9.8 m/s ² X, Y, and Z directions: 100 min. (Sweep time: 10 min. x Sweep count 10 times = Total: 100 min.)		
	Shock resistance		JIS C 60068-2-27 compliant: 147 m/s ² X, Y, and Z directions three times		
Structure	Dimensions (W×H×D mm) *2		44 × 124 × 111.4 (UPS control unit 20 A) 80 × 124 × 111.4 (battery unit 20 A)	52 × 124 × 111.4 (UPS control unit 40 A) 150 × 124 × 111.4 (battery unit 40 A)	
	Weight	Weight of control unit	Approx. 0.6 kg	Approx. 0.7 kg	
		Weight of battery unit	Approx. 1.5 kg	Approx. 2.5 kg	
	Cooling method		Natural cooling		
Dielectric breakdown voltage	Withstand voltage		DC external terminals to casing: 510 V AC, 1 minute, leakage current 5 mA max.		
	Insulation resistance		DC external terminals to casing: 20 MΩ or more. (500 V DC)		
Standard compliance	Safety standard		UL508/CE/UKCA/C22.2 No. 107.1-01		
	EMI	Radiation disturbance field strength	EN61000-6-4/FCC/ICES/RCM/KC		
Internal power consumption (normal *4 / maximum *5)		7 W/29 W	15 W/58 W		
Serial communication	RS-232C (Interface terminal)		Yes (RJ45)		
	USB (Interface terminal)		Yes (RJ45)		
I/O signal (Interface terminal)		Yes (RJ45)			
Accessories		USB cable (2.2 m) (included with control unit) Battery communication cable (included with battery unit)			

S8BA-SBF

Description	Capacity	480 W	960 W
Accessory functions		Remote ON/OFF signal logic setting; Battery life counter setting; Maximum backup time setting; Startup battery level setting; Backup stop (BS) signal delay time setting; and Backup (BU) signal delay time setting	

*1. Guideline for a standard installation. Not a guaranteed value.

*2. Unit dimensions excluding the DIN rail stopper.

*3. When using in an environment at a high temperature, charging may be paused by charging temperature protection, then the charging time will be longer than specified time.

*4. Conditions: With rated loads connected, at a rated input voltage, and at a full battery charge.

*5. Conditions: With rated loads connected, at a rated input voltage and at maximum battery charging current.

Nomenclature

Front view

S8BA-24D24D480SBF

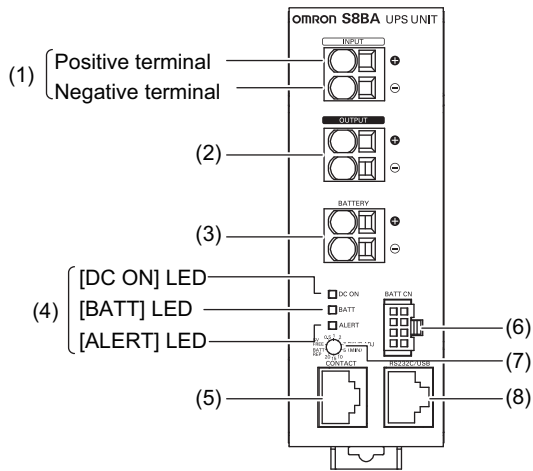

S8BA-S480L

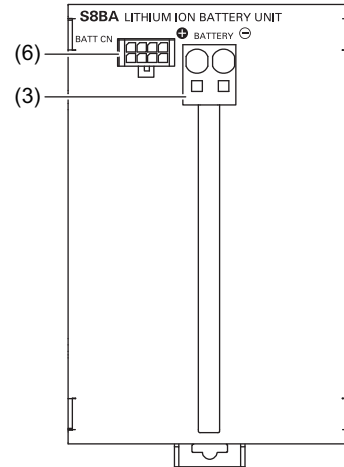

No.	Name	No.	Name
(1)	DC input terminal block	(5)	CONTACT port
(2)	DC output terminal block	(6)	Battery communication port
(3)	Battery connection terminal block	(7)	Mode selection / Backup time setting switch
(4)	LED indicators	(8)	RS232C / USB port

S8BA-24D24D960SBF

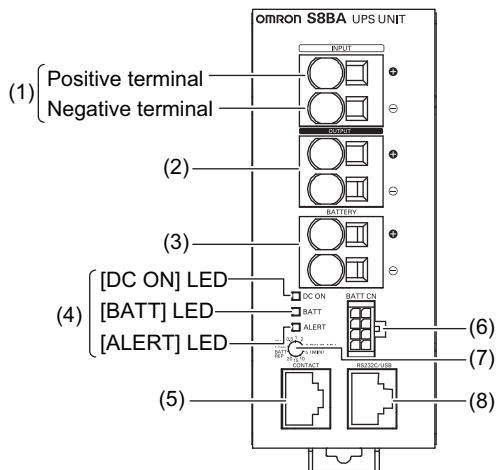

S8BA-S960L

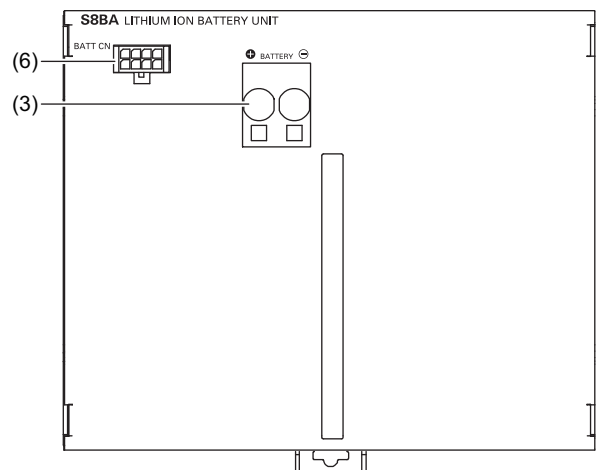

No.	Name	No.	Name
(1)	DC input terminal block	(5)	CONTACT port
(2)	DC output terminal block	(6)	Battery communication port
(3)	Battery connection terminal block	(7)	Mode selection / Backup time setting switch
(4)	LED indicators	(8)	RS232C / USB port

S8BA-SBF

Rear view

S8BA-24D24D480SBF

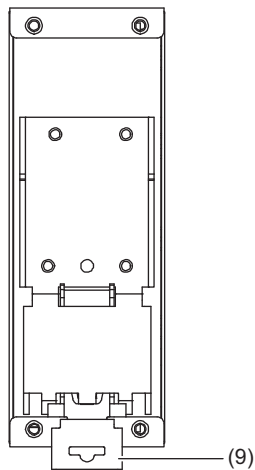

S8BA-S480L

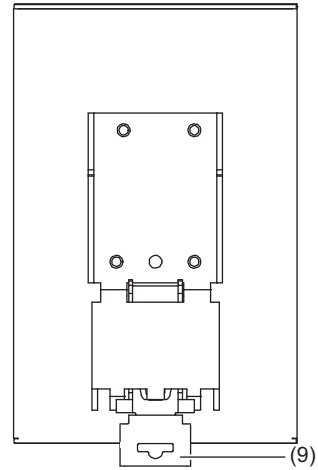

No.	Name
(9)	DIN rail hook

S8BA-24D24D960SBF

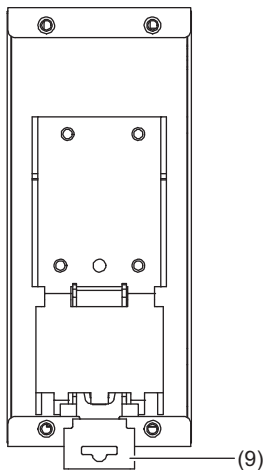

S8BA-S960L

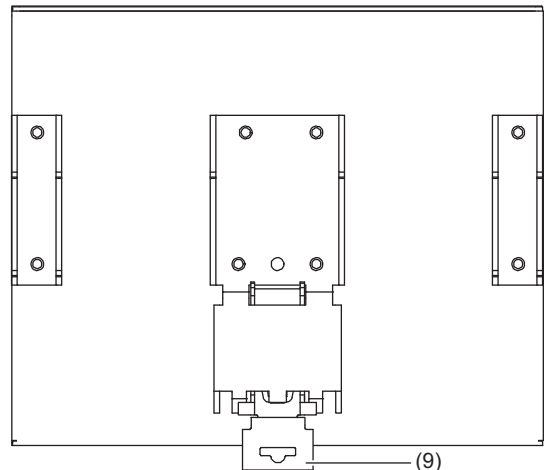

No.	Name
(9)	DIN rail hook

Connections

Block Diagrams

S8BA-24D24D□□□SBF

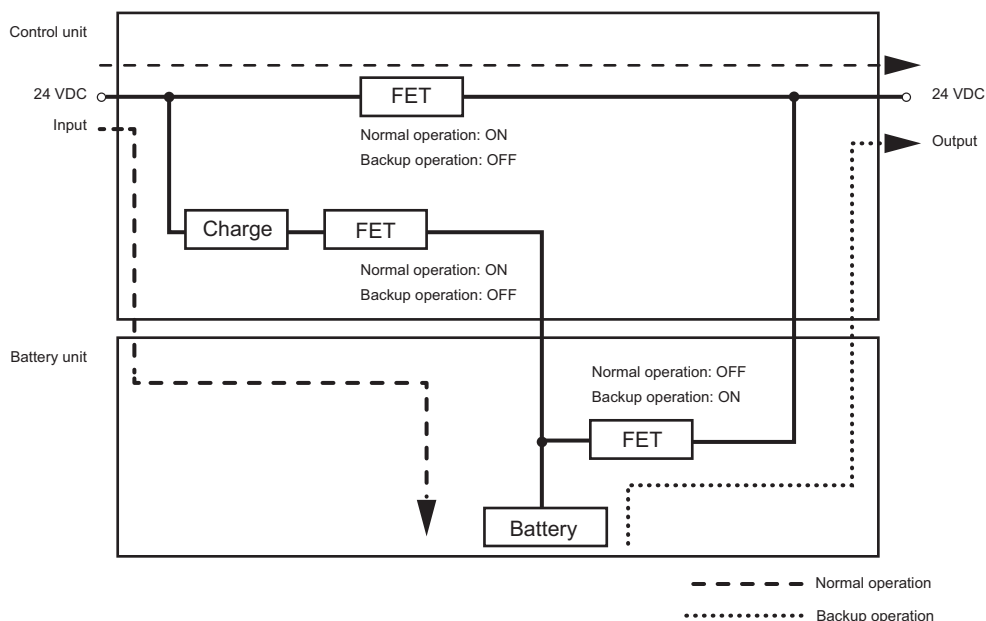

Note: 1. In normal operation, 24 VDC is output as-is for charging the battery and from the input power supply. If the 24 VDC from the input power supply becomes lower, the operation automatically switches to backup operation, and 24 VDC is output from the battery.

Input and output voltage time chart when shifting to backup operation

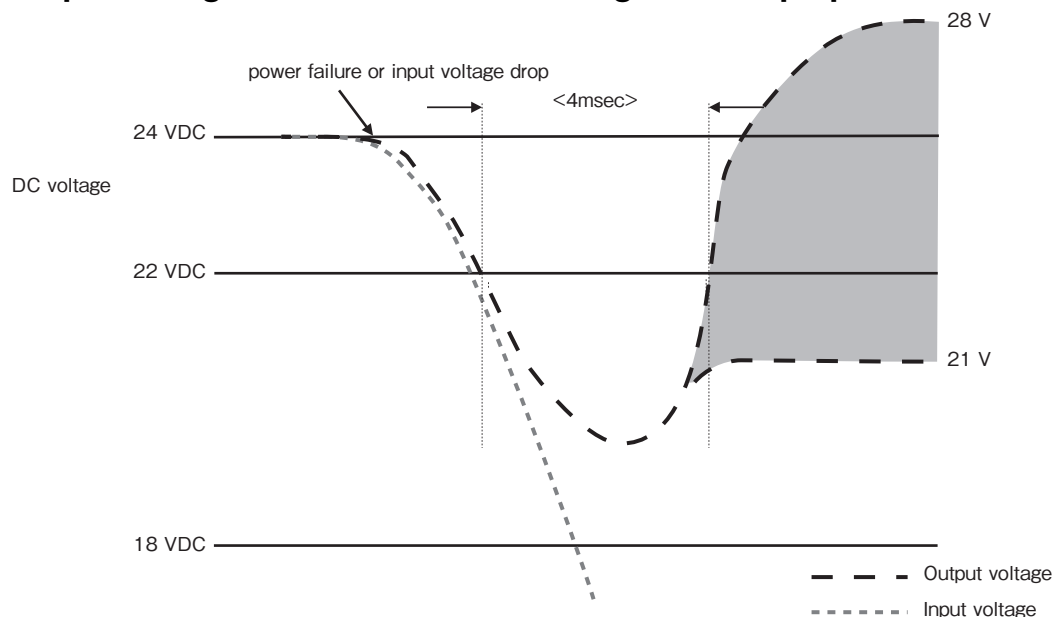

Connecting a cable to the input terminal block and the output terminal block

For details about the connectable sizes and recommended cable sizes, see the following table.

		20 A		40 A	
Connectable sizes	Cable	Solid wire	0.2 to 10 mm ²	0.75 to 16.0 mm ²	
		Stranded wire	0.2 to 6 mm ²		
		AWG	AWG 8 to 24	AWG 6 to 18	
Stripped cable length		8 to 10 mm		18 mm	
Recommended sizes	Cable	Solid wire / Stranded wire	3.5 mm ²	8.0 to 14.0 mm ²	
		AWG	AWG 12	AWG 6 to 8	
Temperature rating for recommended cable			90°C		

I/O signal functions

Type of output signals

Signal	Description
Backup signal output (BU)	Stays ON during backup operation at a power failure.
Low battery level signal output (BL)	Goes ON when the battery becomes weak during backup operation at a power failure.
Trouble signal output (TR)	Goes ON when an internal failure of the UPS occurs or when the battery life counter expires.
Battery replacement signal output (WB)	Goes ON when the test determines that battery replacement is necessary due to deterioration or when the battery life counter goes off-scale. (The battery life counter goes on counting during the input power is being supplied.)

Type of input signals

Signal	Description
Input of the UPS stop signal (BS)	When the BS signal is ON (High), the output of the UPS is stopped after the time period specified in advance has elapsed.*
Remote ON/OFF signal	Remote ON/OFF signals can be used to start and stop the UPS, by using either an externally connected contact or the ON/OFF status of the open collector circuit. When signal is OFF, the UPS will be turned on. When signal is ON, the UPS will be turned off. In the factory settings, the UPS stops operation when this is short-circuited. You must connect the unit to the input power supply to be able to use this function.

* BS signal delay time

It is possible to set the period of time from when a BS signal is received until the output of the UPS is stopped. The output of the UPS can be stopped by inputting the voltage signal (High).

I/O signal port (RJ45 connector)

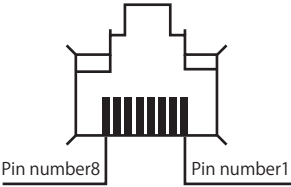
Appearance of the port	Pin number	Cable color	Item
	1	White/orange	Backup signal output (BU)
	2	Orange	Remote ON/OFF input (-)
	3	White/green	Trouble signal output (TR)
	4	Blue	COMMON (COM)
	5	White/blue	Battery LOW signal output (BL)
	6	Green	Backup stop signal input (BS)
	7	White/brown	Battery Replacement Signal output (WB)
	8	Brown	Remote ON/OFF input (+)

Contact signal ratings

Signal	Description
Signal output (BL, TR, BU, WB)	<ul style="list-style-type: none"> Applicable voltage: 50 VDC or less Maximum current: 500 mA BU signal min. response time: 10 ms
Remote ON/OFF	<ul style="list-style-type: none"> Voltage between terminals: 3.3 VDC Current when closed: 10 mA max. Min. signal response time: When stopped 100 ms When restarting 300 ms
UPS Stop Signal input (BS)	<ul style="list-style-type: none"> Input voltage: HIGH (ON) 8 to 24 VDC LOW (OFF) 0.5 VDC or less Input current: 250 mA Min. signal response time: When stopped 100 ms When restarting 300 ms

Contact signal circuit

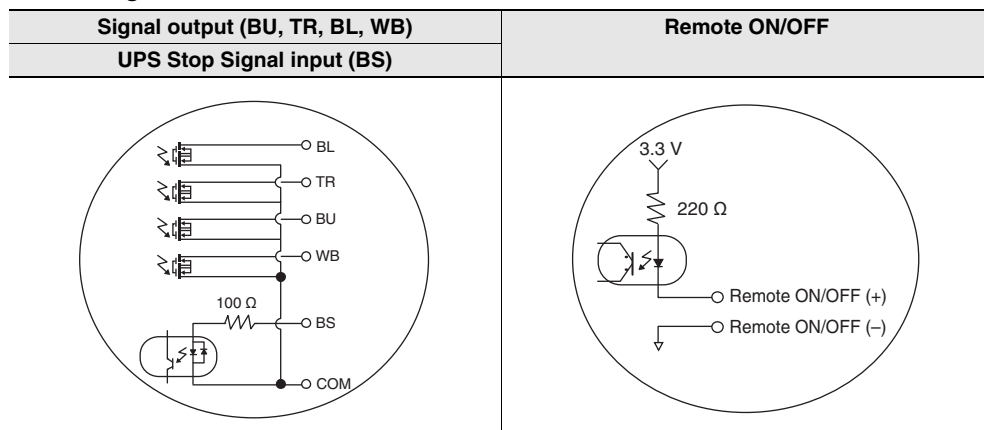

Precautions when selecting switch mode power supplies

When selecting switch mode power supplies, install devices with a capacity larger than the total of the UPS internal power consumption and internal power consumption of connected devices to the input side of the UPS. When these conditions are met, usage will be possible with no problems even if the rated capacity of the UPS is larger than the rated capacity of the switching power supply.

Switch mode power supply capacity > (UPS internal power consumption + Internal power consumption of connected devices)

(Ex.)

$$\text{Switch mode power supply (Capacity: 99 W or more)} > \left(\text{UPS (Internal power consumption: 29 W)} + \text{Industrial-purpose computers (IPC)/controllers, etc. (Internal power consumption: 70 W, DC input)} \right)$$



S8BA
(Capacity: 480 W)

Engineering Data

Estimated backup time

The backup time varies depending on the capacity of connected devices.

After calculating the total capacity of connected devices, refer to the graph of the backup time to obtain an estimation of the initial value of the backup time. (This is also applied to checking the battery.)

1. Convert the total capacity (power consumption) of the connected devices to watts (W).

For the indication of connected devices, check your computer and the rear of the display.

The indicator can show values in two different ways: amperes (A), and watts (W).

Example 1: 24 VDC, 145 W

Example 2: 24 VDC, 1.8 A

Indication	Value
A	$W = A \times 24$

For devices that use the A indication, convert the capacity into W.

Example 2: 1.8 (A) = 1.8×24 (W) = 43.2 (W)

2. Add the values converted into W to obtain the total capacity of the connected devices.

3. Calculate the initial value of the backup time for the total capacity of the connected devices from the graph below.

- Graph of backup time (graph of initial values for products that have not been used at 25°C). The backup time becomes shorter than the graph (table) below when temperature is lower.

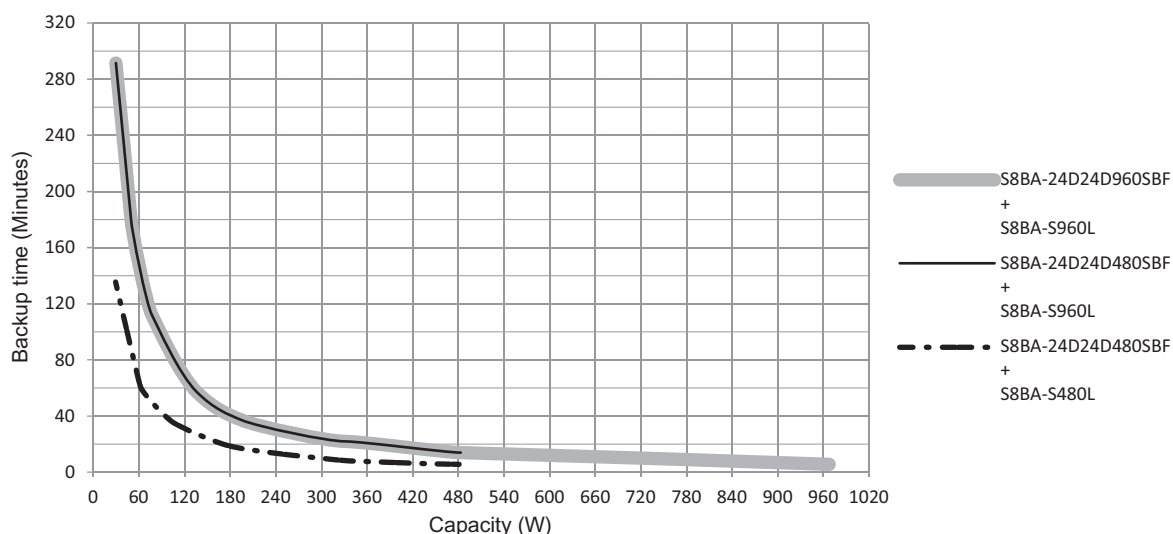

- The smaller the capacity of connected devices becomes, the longer the backup time becomes.

Model	Capacity (Watt)																	
	30	60	90	120	180	240	300	360	420	480	540	600	660	720	780	840	900	960
480W (S8BA-24D24D480SBF + S8BA-S480L)	134	63	41	29	19	15	11	9	8	6	---	---	---	---	---	---	---	---
480W (S8BA-24D24D480SBF + S8BA-S960L)	290	138	94	66	43	30	24	20	16	14	---	---	---	---	---	---	---	---
960W (S8BA-24D24D960SBF + S8BA-S960L)	290	138	94	66	43	30	24	20	16	14	13	12	11	10	9	8	7	6

Note: These backup times are for reference only. Times may vary according to battery life and external environmental conditions (temperature, etc).

Derating curve

Standard mounting (15 mm or more space between the left and right)

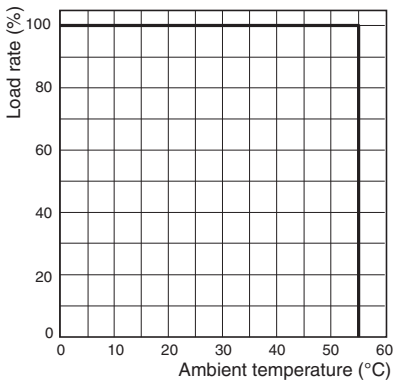

Contact mounting (Less than 15 mm space between the left and right)

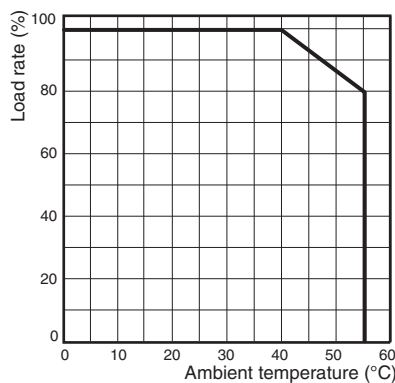

**Backup operation sequence in the event of power failure/voltage drop (instantaneous voltage drop)
When the input power supply recovers while the battery level is sufficiently high**

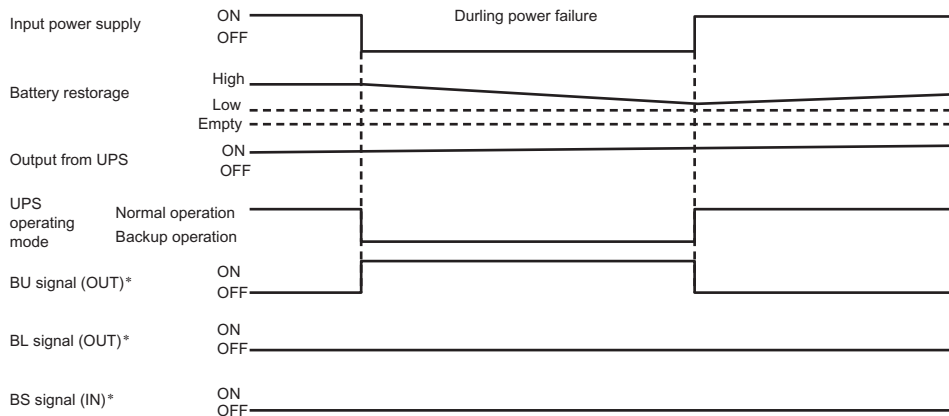

* For details, refer to I/O signal functions on page 26.

When the input power supply recovers while the battery level is Low

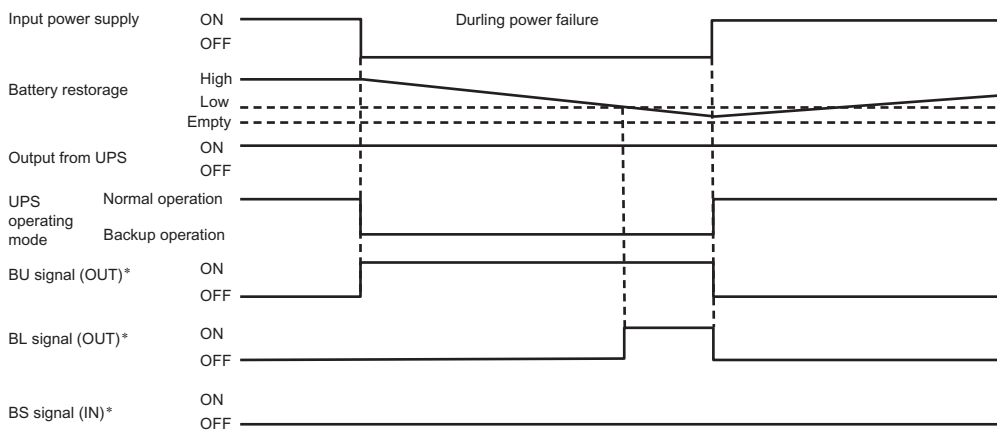

* For details, refer to I/O signal functions on page 26.

When the input power supply does not recover until the battery becomes empty

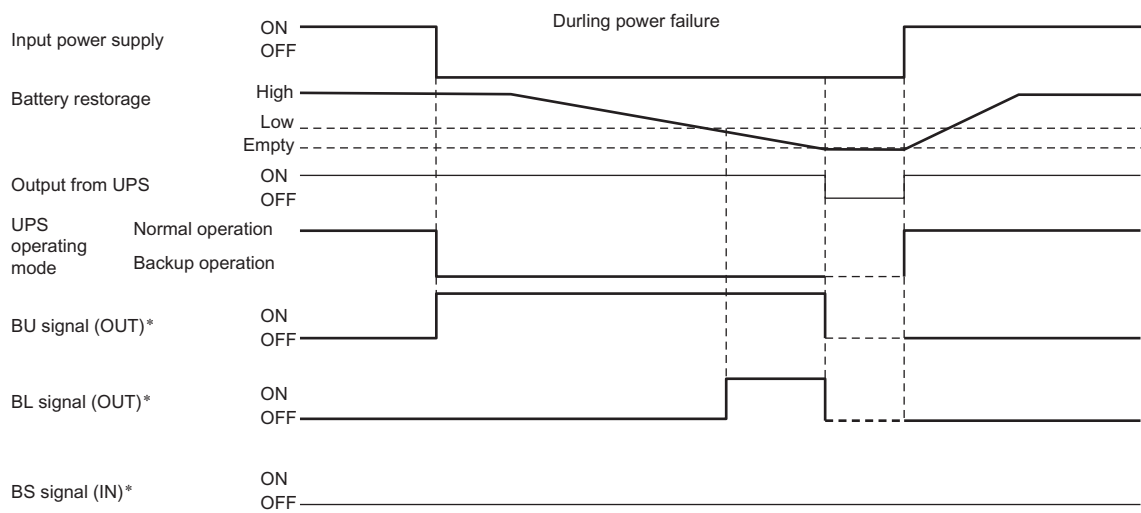

* For details, refer to I/O signal functions on page 26.

Overcurrent protection curve

480 W/960 W

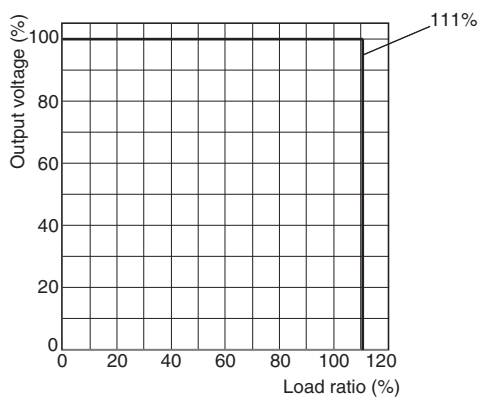

Dimensions

Control unit

S8BA-24D24D480SBF

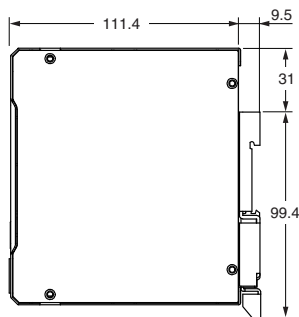
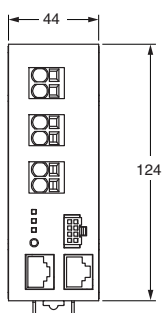

S8BA-24D24D960SBF

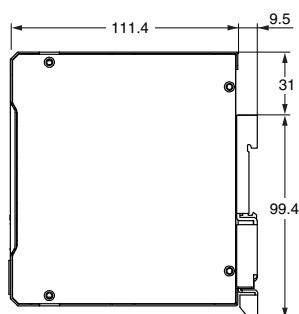
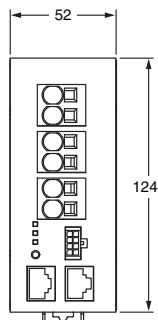

Battery unit

S8BA-S480L

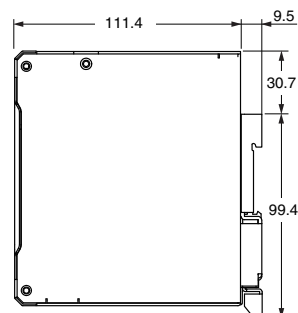
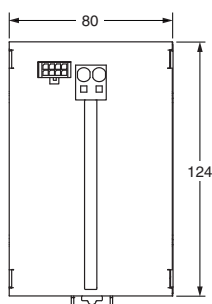

S8BA-S960L

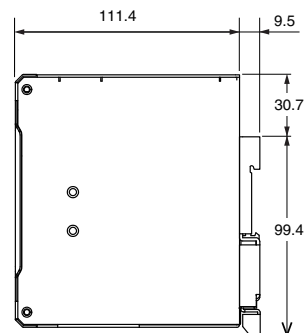
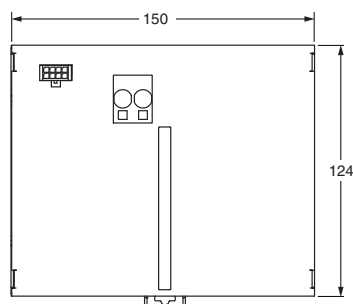

DIN Rail (Order Separately)

Mounting Rail (Material: Aluminum)

PFP-100N
PFP-50N

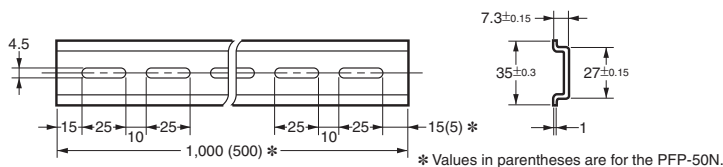
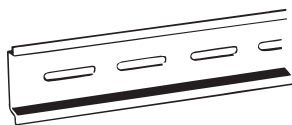

Mounting Rail (Material: Aluminum)

PFP-100N2

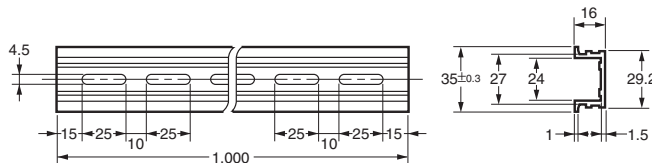
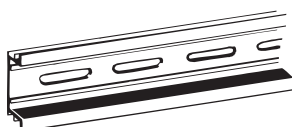

End Plate

PFP-M

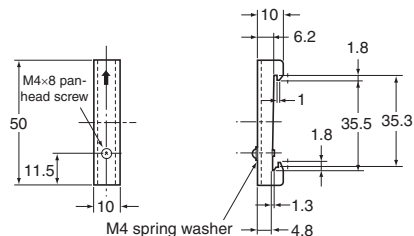

- Note:**
1. If there is a possibility that the Unit will be subject to vibration or shock, use a steel DIN Rail. Otherwise, metallic filings may result from aluminum abrasion.
 2. If the Unit may be subjected to sliding to either side, attach an End Plate (model PFP-M) on each side of the Unit.



Power management solutions

The following software is available as a free download from our website.







Name	Description	Conditions	Interface
Power Attendant Lite	<ul style="list-style-type: none"> You can execute computer shutdown and UPS auto stop when an input power problem occurs (power failure, etc.). You can use a computer that has "Power Attendant Lite" installed to send a script over the network to devices that do not have shutdown software installed to log in to each device and execute a device shutdown command. You can automatically start and stop computers and the UPS according to a preset schedule. 	<For Windows> Windows 11/10/8.1/8 Windows Server 2022/2019/10T 2019 for Storage/2016/2012 R2/2012 Windows Storage Server 2016/2012 R2/2012 Windows 10 IoT Enterprise LTSC Windows Embedded Standard 7 <For Linux> Red Hat Enterprise Linux 8.5/8.4/8.3/8.2/8.1/8.0/7.9/7.8/7.7/7.6/7.5/7.4/7.3/7.2/7.1/7.0 CentOS 8.4/8.3/8.2/8.1/8.0/7.9/7.8/7.7/7.6/7.5/7.4/7.3/7.2/7.1/7.0	RS232C USB
Simple Shutdown Software	<ul style="list-style-type: none"> You can execute computer shutdown and UPS auto stop when an input power problem occurs (power failure, etc.). You can modify and recompile the source code to incorporate a UPS management function into your Windows/Linux® system. Supports Windows and Linux 	<For Windows> Windows 11/10/8.1/8 Windows Server 2022/2019/2016/2012 R2/2012 Windows 10 IoT Enterprise LTSC Windows Embedded Standard 7 <For Linux> Red Hat Enterprise Linux 8.5/8.4/8.3/8.2/8.1/8.0/7.9/7.8/7.7/7.6/7.5/7.4/7.3/7.2/7.1/7.0 CentOS 7.9/7.8/7.7/7.6/7.5/7.4/7.3/7.2/7.1/7.0	RS232C USB
Setting Utility	This software is used to configure UPS settings. (Setting item examples) Function for sending commands Function for saving settings to a backup file Function for restoring settings from a backup file Function for reading UPS settings Function for returning UPS settings to default settings	Windows 11/10/8.1/8 Windows Server 2022/2019/2016/2012 R2/2012 Windows 10 IoT Enterprise LTSC Windows Embedded Standard 7	RS232C USB

Safety Precautions

Warning Indications

 Warning	Indicates a potentially hazardous situation that, if not avoided, could result in serious injury or death. Additionally there may be significant property damage.
 Caution	Indicates a potentially hazardous situation that, if not avoided, could result in minor or moderate injury or property damage.
Precautions for Safe Use	Supplementary comments on what to do or avoid doing, to use the product safely.
Precautions for Correct Use	Supplementary comments on what to do or avoid doing, to prevent failure to operate, malfunction or undesirable effect on product performance.

Meaning of Product Safety Symbols

	General inhibition Notice prohibiting an unspecified general action.
	General instruction Notice instructing an unspecified general action.
	Do-not-disassemble prohibition Notice prohibiting disassembly because disassembling the device may cause such an accident as an electric shock.
	Prohibition of use in locations subject to water such as a bathroom and shower room Notice prohibiting installation of the device in locations subject to water, because if a device not made water-proof is used in such locations, injury may occur due to an electric leak.
	Do-not-touch prohibition Indicates the possibility of injuries by touching the specific portion of the device under specific conditions, prohibiting touching of the device.
	Explosion alert Notice alerting the user to the possibility of explosion under certain conditions.

Warning

(for use of this product)

- Provide safety measures outside the UPS to ensure safety in the entire system even if the UPS is damaged or an abnormality occurs due to an external factor. Not doing so may result in serious accidents due to incorrect operation. 

(Wiring)

- Do not short between the connector terminals. 
- Doing so may result in electric shock.
 - The battery unit's protection board may be damaged due to a short-circuit.
 - Connect each connection cable to the correct connected device.
 - Connect the terminal of each connection cable to the connector port with correct polarity.
 - Be sure to follow the connection procedure described in User's Manual (NUD-D18006A)

(When replacing the battery unit)

Dispose of or collect (recycle) the battery unit according to your own rules set for that purpose or as instructed by laws and regulations.

- Do not dispose of it in fire. Otherwise, it could explode.



Caution

(for installation and connection)

Pay attention to the weight and balance when carrying the unit, and install it in a solid and stable location. 

- Do not drop the battery unit and do not expose it to strong impact. Dropping the unit may result in injury or fire.
- If you drop the unit, have it inspected and repaired. For repairs, contact our sales personnel.

Keep plastic package bags out of reach of children. 

- Children may suffocate if they place their heads into plastic bags.

Be sure to connect the input power supply of the unit to a DC power supply device having a rated voltage (24 VDC), or a battery power feed system. 

- The input voltage ranges for the UPS are as shown below. Check that the output voltage of the DC power supply device connected to the input terminal of the UPS is within any of the voltage ranges below.
 - Voltage range: 23 to 28 V DC
- Connecting to a DC or AC power supply device with a different voltage may result in malfunction in or damage to the UPS, or cause a fire.

When an abnormality (unusual sound or smell) occurs, turn OFF the unit's "Power," switch to stop the output, and stop the supply of commercial power. 

To make an emergency stop, move the rotary switch to "BATT REP", and when the LED changes from a fast blink to a slow blink, shut off the input power.

- When performing maintenance on the connected devices, follow the above instructions to ensure safety.

When installing the input cable, make sure to perform the connection as specified. 

Make sure to stop the primary power supply before connecting the unit to the input power supply terminal.

- When connecting a cable to the terminal block, use a cable that complies with the input current specification of the UPS. Failure to do so may result in electric shock or ground fault.

Do not disassemble, repair, or modify the unit. 

- Doing so may cause an electric shock or a fire.

Do not install the unit in other than specified orientations. 

- Dropping or toppling the unit may cause injury.
- If you install the unit in an orientation other than specified, the internal temperature may rise, eventually damaging the UPS or deteriorating the battery.

Do not use the unit at a location where the operating environment temperature is more than 55°C

- The battery deteriorates rapidly. It may result in fire.
- If the battery's resin separator is damaged, the battery may be short-circuited inside, and may cause an abnormal heating, smoke, rupture or fire.
- Doing so may cause a failure or malfunction of the unit.



Do not exceed the ranges specified for environmental conditions during use/storage.

Do not install or store the unit in the places listed below.

- Do not store in places where the humidity is lower than 10% or higher than 90%.
- Do not use the unit in places where the ambient temperature is lower than 0°C or higher than 55°C. (With no condensation)
- Do not use in places where the humidity is lower than 10% or higher than 90%.
- Do not install/store the unit in closed places such as cabinets with no clearance, places where there is flammable or corrosive gas, places with large amounts of dust, places exposed to direct sunlight, places exposed to shock or vibration, salty or wet places, or outdoors.
- Installation or storing the unit in such a place may cause a fire.



When you use plug strip and other plugs to connect additional devices, do not connect devices that exceed the current capacity of the available plugs.

- The current protection of the unit may operate, which may stop the output.
- The cable heats up, which may cause a fire.



Do not use a cable with damaged insulation.

Do not pinch or sharply bend the cable.

Do not fold or knot the cable.

- Doing so may cause the cable to be damaged or heated, which may cause an electric shock or a fire.
- If the cable is damaged, stop using the unit and have the cable repaired.
- For repair, contact our sales personnel.



Do not connect any devices other than rated voltage is 24 VDC.

- The rated output voltage of this unit is 24 VDC.
- Overvoltage or overcurrent may damage the connected devices.
- The output voltage range is 22 to 30 VDC.



All of the included accessories are designed to be used with the unit. Do not use the accessories with other devices.

- Doing so may compromise the safety of devices.



When this product is used in compliance with CE/UKCA marking, please use under 2 m communication cable.



Do not block the air vents (upper and lower).

- Doing so will cause the internal temperature to rise, which may cause the unit to fail and the battery to deteriorate.
- During installation, leave a space of 50 mm or more above the top and below the bottom.



Do not connect the RS-232C/USB port or the CONTACT port to a LAN device.

- Connection to a LAN device may result in malfunction in or damage to the UPS or the LAN device.



Do not remove the dust cover for ports that are not in use (RS-232C, CONTACT).

- If the RS-232C and CONTACT port are incorrectly connected, it may cause smoke or fire.



Do not run this unit in series operation and in parallel operation.

- Operating this unit in series and in parallel may cause a failure or malfunction.



(for use)

Do not allow the unit to come in contact with water.

- Doing so may cause an electric shock or a fire.
- Doing so may cause an abnormal heating, smoke, rupture, or fire on the battery.
- If the unit comes in contact with water, immediately stop using it and have it inspected and repaired. To make an emergency stop, turn the rotary switch to "BATT REP" and turn off the input power after the LED changes from fast blinking to slow blinking.
- For repair, contact our sales personnel.



When the battery unit is dead, replace it immediately or stop using the unit.

- Continuing the use of it may cause fire or electric shock due to liquid leaks.



Ambient temperature	Expected life
25°C	10 years
35°C	6.7 years
45°C	3.7 years
55°C	1.9 years

* The values in the table are the expected life under standard use conditions and are not guaranteed.

Occasionally, wipe off dust on the input terminal block and the output terminal block with a dry cloth.

- Accumulated dust may cause a fire.

Before wiping off dust, stop all connected devices and the unit, and stop the supply of commercial power. The unit will stop after 30 seconds of setting the mode selection/backup operation time selection switch to "0.5".



Do not use the unit in a closed place and do not cover the unit.

- Doing so may cause abnormal heating or a fire.



If you notice something unusual such as abnormal sound or smell, discoloration, deformation, and heating, turn OFF the unit's power and stop the supply from the input power supply.



To make an emergency stop, move the rotary switch to "BATT REP", and when the LED changes from a fast blink to a slow blink, shut off the input power.

- Using the unit under such conditions may cause an abnormal heating, rupture or fire.
- If you notice such a condition, stop using the unit and contact our sales personnel for inspection and repairs.

If fluid leaks from the interior, do not touch the fluid.

- Doing so may cause blindness or burns.
- If the fluid contacts your eyes or skin, wash it out with lots of clean water and consult your doctor. The fluid may damage your eye if your eye is left untreated.



Do not place any objects on the unit, and do not drop heavy objects onto the unit.

- Doing so may cause distortion/damage to the case or a failure of the internal circuit, which may cause a fire.



The unit is equipped with an output circuit that can supply power to the connected devices even if the unit stops due to a failure or mis-operation of the internal circuit function. If you want to stop the output, stop the source of the "input power supply".



- Output is continuing even when all indicators of the front panel are off.

When charging the battery, if the battery cannot be charged completely even after the predetermined charging time, turn OFF the "Power" switch of the unit to stop charging the battery.



The unit will stop after 30 seconds of setting the mode selection/backup operation time selection switch to "0.5".

- Otherwise, it may cause an abnormal heating, smoke, rupture or fire on the battery.

(for maintenance)

When performing maintenance of the connected equipment, turn OFF the unit's power and stop the supply from the input power supply.



The unit will stop after 30 seconds of setting the mode selection/backup operation time selection switch to "0.5".

- Even if the input power supply is stopped in the operating state, the power supply output of the unit will not stop, and power will be supplied from the battery.

Do not disassemble, repair, or modify the unit.

- Doing so may cause an electric shock or a fire.



If fluid leaks from the interior, do not touch the fluid.

- Doing so may cause blindness or burns.
- If the fluid contacts your eyes or skin, wash it out with lots of clean water and consult your doctor.



Do not throw the unit into fire.

- Since the battery is incorporated in the unit, the insulator may melt, the gas exhaust valve or protection mechanism may be damaged, or the electrolyte may catch fire, and it may result eventually in an abnormal heating, smoke, rupture or fire.



Do not insert metal objects into the input terminal block and the output terminal block of the UPS.

- Doing so may result in electric shock.



Do not insert metal objects into the battery connectors.

Do not short between the connector terminals.

- Doing so may result in electric shock.
- The battery unit's protection board may be damaged due to a short-circuit.



(for battery replacement)

Do not use other than the designated battery unit.

- Not doing so may cause a fire.
- Product model: S8BA-S480L, S8BA-S960L



Do not replace the battery unit in a place where there is flammable gas.

- Spark may occur when connecting the battery unit, which may cause an explosion or fire.



If fluid leaks from the battery unit, do not touch the fluid.

- Doing so may cause blindness or burns.
- If the fluid contacts your eyes or skin, wash it out with lots of clean water and consult your doctor.



Do not disassemble or modify the battery unit.

- A safety mechanism and protection mechanism to prevent danger are embedded into the battery unit. If these are damaged, it may cause the battery to emit heat, smoke, explode, or catch fire.



Do not drop the battery unit and do not expose it to strong impact.

Dropping the unit may result in injury or fire.

- Doing so may cause a leakage, abnormal heating, smoke, rupture or fire on the battery unit. And, if the battery unit's protection mechanism is broken, the battery may be charged at an abnormal current or voltage, an abnormal chemical reaction may occur inside the battery, and it may result eventually in an abnormal heating, smoke, rupture or fire.



Do not short the battery unit with metal objects.

- Doing so could cause an electric shock, fire or burn.
- Some electrical energy still remains inside the spent battery unit.



Do not dispose of battery units in a fire.

- The insulator inside the battery unit may melt, the gas exhaust valve or protection mechanism may be damaged, or the electrolyte may catch fire, and it may result eventually in abnormal heating, smoke, rupture or fire.



Precautions for Safe Use

Before using

- The battery has not been charged at the time of purchase. Be sure to charge it before use.
- Connect this unit to the input power supply to charge the battery unit.

When moving the unit from a cold place to a warm place, leave it for several hours before using it.

- If the unit is promptly turned ON after being moved to a warmer place, condensation may form inside the unit and cause it to fail.

Take measures for handling unforeseen accidents, such as data backup and system redundancy.

- The output may stop when there is failure in this unit.

Do not conduct with stand voltage test and insulation resistance test.

- Surge absorption components may be damaged.

Connecting

Do not short the unit output lines together. Do not short positive side of the unit outlines to ground and the battery connection cable to ground.

- The unit may fail.

In the event you transfer or sell this unit to a third party, please include all of the documentation that came with the unit. This is to ensure that the unit is used in line with the conditions described in the included documentation.

Using

Before stopping the commercial power to the unit, turn OFF the "Power" switch of the unit.

The unit will stop after 30 seconds of setting the mode selection/backup operation time selection switch to "0.5".

- The unit enters Battery Mode when input power supply is stopped.
- If the frequency of backup operation becomes high, the battery life may be significantly reduced.

Do not use for an application that frequently requires Battery Mode.

- The battery unit will deteriorate and fail to maintain the specified backup time.

If you want the UPS to stand by in a UPS startup state, set 3 months or less for the input power supply stop period.

- The UPS startup state means the state of waiting for startup triggered by a remote ON/OFF or BS signal.
- If the UPS is left unused in the above state for 3 months or longer, the battery goes into overdischarge state, and the backup time may become shorter or the battery may become unusable.

Storing

Storing the battery in UPS for a long term, store at an environment less than 25°C and recharge 15 to 30 minutes the battery within 1 year.

- The battery self-discharges even when it not being used, and it goes into overdischarge state if it is left for a long period of time. The backup time may become shorter or the battery may become unusable.
- We recommend keeping the temperature 25°C or less when storing the unit for long periods of time.
- Turn OFF the unit's power when storing it.

Do not install or store the unit in a place exposed to direct sunlight.

- The rise of temperature may cause the battery unit to deteriorate rapidly and become unusable.

Correct Installation Method

- For installation, to improve the long time reliability of the UPS, pay much attention to heat dissipation. Ensure convection of air around the UPS main body, and use the UPS in an operating condition below the derating curve.
- During machining work for mounting, make sure that no metal scrap goes into the product.
- The heat dissipation of the UPS may become worse depending on how the UPS is mounted; in rare cases, internal components may deteriorate and get damaged. Use the UPS in an operating condition based on the derating curve for each mounting direction.

Standard mounting

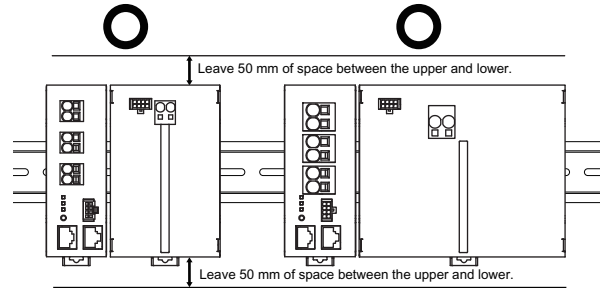

- Note: 1.** This UPS can be mounted with the sides in close contact. Up to 3 units can be mounted in close contact. Follow the derating curve during mounting with the sides in close contact.
- 2.** When you install devices other than the UPS on the left or the right of the UPS, leave a space of at least 15 mm.

Face-up mounting

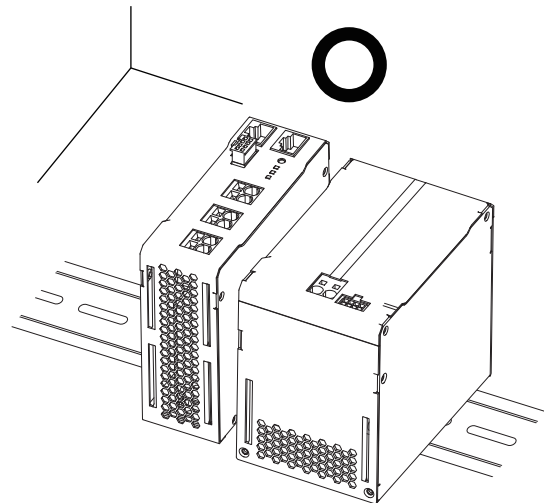

Incorrect Installation Method

Mounting to the DIN Track

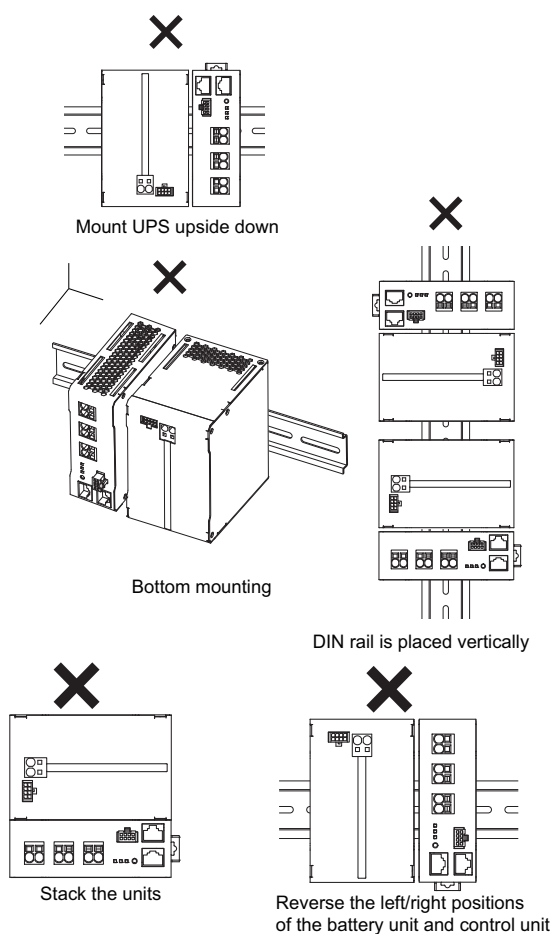

Battery unit Replacement

The UPS supports hot swapping. Battery unit replacement is possible both when the power is turned OFF (while the power output is OFF) and when the power is turned ON (while the power output is ON).

Precautions for Correct Use

- When replacing the battery unit, set the unit to "BATT REP" (Battery unit replacement mode) using the mode selection / backup operation time selection switch.
(Perform a reset with the "input power supply" ON.)
- When you replace the battery, the battery life counter automatically resets.
If you replace the battery unit without activating the battery unit replacement mode, the battery life may not be detected accurately because the battery life counter is not reset.
- Do not replace the battery unit while the UPS is operating in backup mode. Output will stop.
- For details on the precautions for maintenance, refer to (for maintenance) on page 35 and (for battery replacement) on page 35.
- If an input power supply error such as a power failure occurs when replacing the battery unit while in operation, backup cannot be performed and output stops.
- The battery unit used in the unit has a limited lifespan. The life varies depending on your use environment and backup frequency.
- The nearer the end of the life is, the more rapidly deterioration proceeds.
The battery unit deteriorates even if it is stored. The higher the temperature is, the shorter the life becomes.

- Do not short between the terminals.
Doing so may result in electric shock.
The protection board inside the battery unit may be damaged due to a short-circuit.
Connect each connection cable to the correct connected device.
Connect the terminal of each connection cable to the connector port with correct polarity.
Be sure to follow the above connection procedure.

Battery check schedule and frequency

Average ambient temperature	6-month check	3-month check
55°C	For the first year after starting use	When 1 year or more have passed after starting use
50°C	For the first 1.5 years after starting use	When 1.5 years or more have passed after starting use
45°C	For the first 3 years after starting use	When 3 years or more have passed after starting use
40°C	For the first 5 years after starting use	When 5 years or more have passed after starting use
25°C	For the first 6 years after starting use	When 6 years or more have passed after starting use

Conformance to EU Directives and UK Legislations

Applicable directives

- EMC Directives

Principles regarding conformance

OMRON electronic devices conform to the related EMC standards so that they can be more easily built into other devices or the overall machine. The actual products have been checked for conformity to EMC standards*.

Whether the products conform to the standards in the system used by the customer, however, must be checked by the customer. EMC-related performance of the OMRON devices will vary depending on the configuration, wiring, and other conditions of the equipment or control panel on which the OMRON devices are installed. The customer must, therefore, perform the final check to confirm that devices and the overall machine conform to EMC standards.

* Applicable EMC (Electromagnetic Compatibility) standards are as follows: EMS (Electromagnetic Susceptibility): EN 61000-6-2, EMI (Electromagnetic Interference): EN 61000-6-4, and EN 61000-6-4 Radiated emission: 10-m regulations

Conformance to EU Directives and UK Legislations

This product complies with EU Directives and UK Legislations. To ensure that the machine or device in which this product is used complies with EU Directives and UK Legislations, the product must be installed as follows:

- This product must be installed within a control panel.
- You must use reinforced insulation or double insulation for the direct power supply equipment connected to this product.
- Models of this product conform to the Common Emission Standard. Radiated emission characteristics (10-m regulations), in particular, may vary depending on the configuration of the control panel used, other devices connected to the control panel, wiring, and other conditions. Therefore, even when using a model of this product, you must confirm and ensure the compliance of the entire machine or equipment.
- This is a Class A product (for industrial environments). In a residential environment, it may cause radio interference. If radio interference occurs, the user may be required to take appropriate measures.

Conformance to UL

Conformance to UL

- This product must be installed within a control panel with an internal heater or other unit to protect against the formation of condensation.
- Gaps in the door to the control panel must be completely filled or covered with gaskets or other material.

Conformance to FCC

FCC CAUTION

Changes or modifications not expressly approved by the party responsible for compliance could void the user's authority to operate the equipment.

- This equipment has been tested and found to comply with the limits for a Class A digital device, pursuant to part 15 of the FCC Rules. These limits are designed to provide reasonable protection against harmful interference when the equipment is operated in a commercial environment.
- This equipment generates, uses, and can radiate radio frequency energy and, if not installed and used in accordance with the instruction manual, may cause harmful interference to radio communications.
- Operation of this equipment in a residential area is likely to cause harmful interference in which case the user will be required to correct the interference at his own expense.

Terms and Conditions Agreement

Read and understand this catalog.

Please read and understand this catalog before purchasing the products. Please consult your OMRON representative if you have any questions or comments.

Warranties.

- (a) Exclusive Warranty. Omron's exclusive warranty is that the Products will be free from defects in materials and workmanship for a period of twelve months from the date of sale by Omron (or such other period expressed in writing by Omron). Omron disclaims all other warranties, express or implied.
- (b) Limitations. OMRON MAKES NO WARRANTY OR REPRESENTATION, EXPRESS OR IMPLIED, ABOUT NON-INFRINGEMENT, MERCHANTABILITY OR FITNESS FOR A PARTICULAR PURPOSE OF THE PRODUCTS. BUYER ACKNOWLEDGES THAT IT ALONE HAS DETERMINED THAT THE PRODUCTS WILL SUITABLY MEET THE REQUIREMENTS OF THEIR INTENDED USE.

Omron further disclaims all warranties and responsibility of any type for claims or expenses based on infringement by the Products or otherwise of any intellectual property right. (c) Buyer Remedy. Omron's sole obligation hereunder shall be, at Omron's election, to (i) replace (in the form originally shipped with Buyer responsible for labor charges for removal or replacement thereof) the non-complying Product, (ii) repair the non-complying Product, or (iii) repay or credit Buyer an amount equal to the purchase price of the non-complying Product; provided that in no event shall Omron be responsible for warranty, repair, indemnity or any other claims or expenses regarding the Products unless Omron's analysis confirms that the Products were properly handled, stored, installed and maintained and not subject to contamination, abuse, misuse or inappropriate modification. Return of any Products by Buyer must be approved in writing by Omron before shipment. Omron Companies shall not be liable for the suitability or unsuitability or the results from the use of Products in combination with any electrical or electronic components, circuits, system assemblies or any other materials or substances or environments. Any advice, recommendations or information given orally or in writing, are not to be construed as an amendment or addition to the above warranty.

See <http://www.omron.com/global/> or contact your Omron representative for published information.

Limitation on Liability; Etc.

OMRON COMPANIES SHALL NOT BE LIABLE FOR SPECIAL, INDIRECT, INCIDENTAL, OR CONSEQUENTIAL DAMAGES, LOSS OF PROFITS OR PRODUCTION OR COMMERCIAL LOSS IN ANY WAY CONNECTED WITH THE PRODUCTS, WHETHER SUCH CLAIM IS BASED IN CONTRACT, WARRANTY, NEGLIGENCE OR STRICT LIABILITY.

Further, in no event shall liability of Omron Companies exceed the individual price of the Product on which liability is asserted.

Suitability of Use.

Omron Companies shall not be responsible for conformity with any standards, codes or regulations which apply to the combination of the Product in the Buyer's application or use of the Product. At Buyer's request, Omron will provide applicable third party certification documents identifying ratings and limitations of use which apply to the Product. This information by itself is not sufficient for a complete determination of the suitability of the Product in combination with the end product, machine, system, or other application or use. Buyer shall be solely responsible for determining appropriateness of the particular Product with respect to Buyer's application, product or system. Buyer shall take application responsibility in all cases.

NEVER USE THE PRODUCT FOR AN APPLICATION INVOLVING SERIOUS RISK TO LIFE OR PROPERTY OR IN LARGE QUANTITIES WITHOUT ENSURING THAT THE SYSTEM AS A WHOLE HAS BEEN DESIGNED TO ADDRESS THE RISKS, AND THAT THE OMRON PRODUCT(S) IS PROPERLY RATED AND INSTALLED FOR THE INTENDED USE WITHIN THE OVERALL EQUIPMENT OR SYSTEM.

Programmable Products.

Omron Companies shall not be responsible for the user's programming of a programmable Product, or any consequence thereof.

Performance Data.

Data presented in Omron Company websites, catalogs and other materials is provided as a guide for the user in determining suitability and does not constitute a warranty. It may represent the result of Omron's test conditions, and the user must correlate it to actual application requirements. Actual performance is subject to the Omron's Warranty and Limitations of Liability.

Change in Specifications.

Product specifications and accessories may be changed at any time based on improvements and other reasons. It is our practice to change part numbers when published ratings or features are changed, or when significant construction changes are made. However, some specifications of the Product may be changed without any notice. When in doubt, special part numbers may be assigned to fix or establish key specifications for your application. Please consult with your Omron's representative at any time to confirm actual specifications of purchased Product.

Errors and Omissions.

Information presented by Omron Companies has been checked and is believed to be accurate; however, no responsibility is assumed for clerical, typographical or proofreading errors or omissions.

- Windows is a registered trademark of Microsoft Corporation in the USA and other countries.
- Linux is a trademark or registered trademark of Linus Torvalds in the USA and other countries.
- Other company names and product names mentioned in this document are the trademarks or registered trademarks of their respective companies.

Note: Do not use this document to operate the Unit.

OMRON Corporation Industrial Automation Company

Kyoto, JAPAN

Contact : www.ia.omron.com

Regional Headquarters

OMRON EUROPE B.V.

Wegalaan 67-69, 2132 JD Hoofddorp
The Netherlands
Tel: (31) 2356-81-300 Fax: (31) 2356-81-388

OMRON ELECTRONICS LLC

2895 Greenspoint Parkway, Suite 200
Hoffman Estates, IL 60169 U.S.A.
Tel: (1) 847-843-7900 Fax: (1) 847-843-7787

OMRON ASIA PACIFIC PTE. LTD.

438B Alexandra Road, #08-01/02 Alexandra
Technopark, Singapore 119968
Tel: (65) 6835-3011 Fax: (65) 6835-2711

OMRON (CHINA) CO., LTD.

Room 2211, Bank of China Tower,
200 Yin Cheng Zhong Road,
PuDong New Area, Shanghai, 200120, China
Tel: (86) 21-5037-2222 Fax: (86) 21-5037-2200

Authorized Distributor:

©OMRON Corporation 2015-2022 All Rights Reserved.
In the interest of product improvement,
specifications are subject to change without notice.

CSM_4_7

Cat. No. U701-E1-05 1122 (0515)