

Original instructions



Model **F3SJ-A** **N**

(Version 2)

SAFETY LIGHT CURTAIN

EN INSTRUCTION SHEET

Please read and understand this instruction sheet before storing, installing, programming, operating, maintaining, or disposing of the products. Please consult your OMRON representative if you have any questions or comments. Please refer to the User's Manual and the Quick Installation Manual for detailed instructions on usage.



© OMRON Corporation 2006-2023 All Rights Reserved. 2

Instructions in the EU languages and a signed EU Declaration of Conformity are available on our website at www.industrial.omron.eu/safety.

LEGISLATION AND SAFETY STANDARDS





- Application of a F3SJ sensor alone cannot receive type approval provided by Article 44-2 of the Labour Safety and Health Law of Japan. It is necessary to apply it in a system. Therefore, when using the F3SJ in Japan as a "safety system for pressing or shearing machines" prescribed in Article 42 of that law, the system must receive type approval.
- The F3SJ is electro-sensitive protective equipment (ESPE) in accordance with European Union (EU) Machinery Directive Index Annex V, Item 2.
- Declaration of Conformity
OMRON declares that the F3SJ is in conformity with the requirements of following EU Directives and UK Legislations:
EU: Machinery Directive 2006/42/EC, EMC Directive 2014/30/EU, RoHS Directive 2011/65/EU,
UK: 2008 No 1597 Machinery (Safety) , 2016 No 1091 EMC, 2012 No 3032 RoHS
4. F3SJ is in conformity with the following standards:
(1) European standards
EN61496-1 (Type 4 ESPE), EN61496-2 (Type 4 AOPD), EN61508-1 through -3 (SIL3), EN ISO 13849-1:2015 (Category 4, PL e)
(2) International standards
IEC61496-1 (Type 4 ESPE), IEC61496-2 (Type 4 AOPD), IEC61508-1 through -3 (SIL3), ISO 13849-1:2015 (Category 4, PL e)
(3) JIS standards
JIS B 9704-1 (Type 4 ESPE), JIS B 9704-2 (Type 4 AOPD)
(4) North American Standards:
UL61496-1 (Type 4 ESPE), UL61496-2 (Type 4 AOPD), UL508, UL1998, CAN/CSA C22.2 No.14, CAN/CSA C22.2 No.0.8
5. The F3SJ received the following approvals from the EU accredited body, TÜV SÜD Product Service GmbH:
•EC Type-Examination in accordance with the EU Machinery Directive, Type 4 ESPE (EN61496-1), Type 4 AOPD (EN61496-2)
•TÜV SÜD Product Service Type Approval, Type 4 ESPE (EN61496-1), Type 4 AOPD (EN61496-2), SIL1, 2, 3 (EN61508-1 through -3), EN ISO 13849-1:2015 (Category 4, PL e)
6. The F3SJ received the certificates of UL listing for US and Canadian safety standards from the Third Party Assessment Body UL.
•Both are: Type 4 ESPE (UL61496-1), Type 4 AOPD (UL61496-2)
7. The F3SJ is designed according to the standards listed below. To make sure that the final system complies with the following standards and regulations, you are asked to design and use it in accordance with all other related standards, laws, and regulations. If you have any questions, consult with specialized organizations such as the body responsible for prescribing and/or enforcing machinery safety regulations in the location where the equipment is to be used.
•European Standards: EN415-4, EN692, EN693
•U.S. Occupational Safety and Health Standards: OSHA 29 CFR 1910.212
•U.S. Occupational Safety and Health Standards: OSHA 29 CFR 1910.217
•American National Standards: ANSI B11.1 to B11.19
•Canadian Standards Association: ANSI/RIA 15.06
•Canadian Standards Association CSA Z142, Z432, Z434
•SEMI Standards SEMI S2
•Ministry of Health, Labour and Welfare "Guidelines for Comprehensive Safety Standards of Machinery", Standard Bureau's Notification No. 501 dated June 1, 2001.

Suitability for Use

Omron Companies shall not be responsible for conformity with any standards, codes or regulations which apply to the combination of the Product in the Buyer's application or use of the Product. At Buyer's request, Omron will provide applicable third party certification documents identifying ratings and limitations of use which apply to the Product. This information by itself is not sufficient for a complete determination of the suitability of the Product in combination with the end product, machine, system, or other application or use. Buyer shall be solely responsible for determining appropriateness of the particular Product with respect to Buyer's application, product or system. Buyer shall take application responsibility in all cases.
NEVER USE THE PRODUCT FOR AN APPLICATION INVOLVING SERIOUS RISK TO LIFE OR PROPERTY OR IN LARGE QUANTITIES WITHOUT ENSURING THAT THE SYSTEM AS A WHOLE HAS BEEN DESIGNED TO ADDRESS THE RISKS, AND THAT THE OMRON PRODUCT(S) IS PROPERLY RATED AND INSTALLED FOR THE INTENDED USE WITHIN THE OVERALL EQUIPMENT OR SYSTEM.

PRECAUTIONS ON SAFETY

Regarding the alert symbols and meanings used for the safe uses in order for our customers to use the F3SJ in safety, precautions are indicated in this manual with the alert symbols and statements such as the followings. Those safety precautions relate to the important descriptions that must be obeyed for the safe uses and operations. Be sure to obey the precautions. The following indications and symbols are used for the descriptions.

	Indicates a potentially hazardous situation which, if not avoided, will result in minor or moderate injury, or may result in serious injury or death. Additionally there may be significant property damage.
	Indicates prohibited actions.
	Indicates mandatory actions.
	Indicates the risk of electric shock.

Alert Statements in this Manual For Users

	WARNING
The F3SJ must be installed, configured, and incorporated into a machine control system by a sufficiently trained and qualified person. An unqualified person may not be able to perform these operations properly, which may cause a person to go undetected, resulting in serious injury.	
When changes are made to each function using the setting tool (F39-GWUM or F39-MC21), the administrator must manage the details of the changes and perform the changes. Accidental functional setting change may cause failure of human body detection, resulting in a serious injury.	
If the device is to be reinstalled to a different facility or if the settings are not clear, reset to the factory default settings.	

For Machines

	WARNING
Do not use this sensor for machines that cannot be stopped by electrical control. For example, do not use it for a pressing machine that uses full-rotation clutch. Otherwise, the machine may not stop before a person reaches the hazardous part, resulting in serious injury.	
Do not use the auxiliary output or external indicator output for safety applications. Human body may not be detected when F3SJ fails, resulting in serious injury.	

For Installation

	WARNING
Make sure to test the operation of the F3SJ after installation to verify that the F3SJ operates as intended. Make sure to stop the machine until the test is complete. Unintended function settings may cause a person to go undetected, resulting in serious injury.	
Make sure to install the F3SJ at the safe distance from the hazardous part of the equipment. Otherwise, the machine may not stop before a person reaches the hazardous part, resulting in serious injury.	
Install a protective structure so that the hazardous part of a machine can only be reached by passing through the sensor's detection zone. Install the sensors so that part of the person is always present in the detection zone when working in a machine's hazardous areas. If a person is able step into the hazardous area of a machine and remain behind the F3SJ's detection zone, configure the system with an interlock function that prevents the machine from being restarted. Failure to do so may result in serious injury.	
Install the interlock reset switch in a location that provides a clear view of the entire hazardous area and where it cannot be activated from within the hazardous area.	
The F3SJ cannot protect a person from an object flying from a hazardous area. Install protective cover(s) or fence(s).	
To prevent personnel approach to dangerous part of the machine through an area disabled by the fixed blanking function, you must install a protective structure to cover the whole disabled area. Failure to do so may cause failure of human body detection, resulting in a serious injury.	
You must ensure that a test rod is detected for all detection areas except where fixed blanking function is used. Failure to do so may cause failure of human body detection, resulting in a serious injury.	
Detection capability gets larger when fixed/floating blanking function is used. You must use the detection capability for fixed and floating blanking functions. Failure to do so may cause failure of machine stop before reaching the machine's dangerous part, resulting in a serious injury.	
You must ensure that the system works as you intended after configuring floating blanking. Failure to do so may result in serious injury.	
Warning zone output is non-safety output. You must not include it to calculation of safety distance. Otherwise safety distance may be reduced, resulting in serious injury.	
A warning zone CANNOT be used for safety applications. Always install your system so that a detection zone should be passed before reaching a source of danger.	
The muting and override functions disable the safety functions of the device. You must ensure safety using other method when these functions are operating.	
Install muting sensors so that they can distinguish between the object that is being allowed to pass through the detection zone and a person. If the muting function is activated by the detection of a person, it may result in serious injury.	
Muting lamps (external indicators) that indicate the state of the muting and override functions must be installed where they are clearly visible to workers from all the operating positions.	
Muting related time must be properly configured for its application by a sufficiently trained and qualified person, and the person must have responsibility for settings, especially when setting the muting time limit to infinite.	
Use independent 2 input devices for muting inputs.	
You must install F3SJ, muting sensor, and physical barrier, and configure time settings for muting so that an operator should not enter hazardous zone.	
A switch to activate the override function must be a hold-to-run device such as a spring return key switch and must be installed in a location that provides a clear view of the entire hazardous zone and where it cannot be activated from within the hazardous zone. Make sure that nobody is in the hazardous area before activating the override function.	
Install the sensor system so that it is not affected by the reflective surface of the F3SJ.	
When using more than 1 set of F3SJ, install them so that mutual interference does not occur, such as by configuring series connections or using physical barriers between adjacent sets.	
Make sure that the F3SJ is securely mounted and its cables and connectors are properly connected.	
Make sure that foreign material such as water, oil, or dust does not enter the F3SJ or the connector while the cap is removed.	
Do not use the sensor system with mirrors in a retro-reflective configuration. Doing so may hinder detection. It is possible to use mirrors to "bend" the detection zone to a 90-degree angle.	
Perform an inspection for all F3SJ as described in "Chapter 6 Checklists" of User's manual. When using series connections, perform inspections for every connected F3SJ.	

For Wiring

	WARNING
Connect the load between the output and 24V line (NPN output). Connecting the load between the output and 0V line will result in a dangerous condition because operation is reversed to "ON when blocked".	
Do not short-circuit the output line to the 0V line. Otherwise, the output is always ON. Also, the +24V of the power supply must be grounded so that output does not turn ON due to grounding of the output line.	
Configure the system by using the optimal number of safety outputs that satisfy the requirements of the necessary safety category.	
Do not connect each line of F3SJ to a DC power supply of more than 24VDC±20%. Also, do not connect to an AC power supply. Failure to do so may result in electric shock.	
For the F3SJ to comply with IEC 61496-1 and UL 508, the DC power supply unit must satisfy all of the following conditions: • Must be within the rated power voltage (24V DC ±20%) • Must have tolerance against the total rated current of devices if it is connected to multiple devices • Must comply with EMC directives (industrial environment) • Double or reinforced insulation must be applied between the primary and secondary circuits • Automatic recovery of overcurrent protection characteristics (reversed L sagging) • Output holding time must be 20ms or longer • Must satisfy output characteristic requirements for class 2 circuit or limited voltage current circuit defined by UL508 • Must comply with laws and regulations, regarding EMC and electrical equipment safety, of the country or region where the F3SJ is used (Ex: In EU, the power supply must comply with the EMC Directive and the Low Voltage Directive.)	
Double or reinforced insulation from hazardous voltage must be applied to all input and output lines. Failure to do so may result in electric shock.	
Extension of the cable must be within a specified length. If it isn't, safety function may not work properly, resulting in danger.	

Other

	WARNING
To use the F3SJ in PSDI mode (Reinitiation of cyclic operation by the protective equipment), you must configure an appropriate circuit between the F3SJ and the machine. For details about PSDI, refer to OSHA1910.217, IEC61496-1, and other relevant standards and regulations.	
Do not try to disassemble, repair, or modify this product. Doing so may cause the safety functions to stop working properly.	
Do not use the F3SJ in environments where flammable or explosive gases are present. Doing so may result in explosion.	
Perform daily and 6-month inspections for the F3SJ. Otherwise, the system may fail to work properly, resulting in serious injury.	

PRECAUTIONS FOR SAFE USE

- Make sure to observe the following precautions that are necessary for ensuring safe use of the product.
- Thoroughly read this manual and understand the installation procedures, operation check procedures, and maintenance procedures before using the product.
 - Loads must satisfy both of the following conditions:
-Not short-circuited
-Not used with a current that is higher than the rating
 - Do not drop the product.
 - Dispose of the product in accordance with the relevant rules and regulations of the country or area where the product is used.

PRECAUTIONS FOR CORRECT USE

Observe the precautions described below to prevent operation failure, malfunctions, or undesirable effects on product performance.

■ Installation environment

- Do not install the F3SJ in the following types of environments:
•Areas exposed to intense interference light, such as direct sunlight
•Areas with high humidity where condensation is likely to occur
•Areas where corrosive gases are present
- Areas exposed to vibration or shock levels higher than in the specification provisions
- Areas where the product may come into contact with water
- Areas where the product may get wet with oil that can solve adhesive
- Do not use radio equipment such as cellular phones, walkie-talkies, or transceivers near the F3SJ.
- This is a class A product. In residential areas it may cause radio interference, in which case the Responsible Person may be required to take adequate measures to reduce interference.
- Install a cover to protect the F3SJ from spatter in an environment where foreign material such as spatter adheres.

■ Wiring and installation

- Make sure to perform wiring while the power supply is OFF. Otherwise, the F3SJ may fail to operate due to the diagnosis function.
- Do not short-circuit output lines to +24V line. Otherwise a fault of F3SJ may occur.
- When extending the communication line with a cable (twisted-pair wire) other than the dedicated cable (F39-JD□□), use a cable with the same or superior specification. Connect the shield to the 0V line.
- When replacing the cable connectors with other types of connectors, use connectors that provide a protection grade of IP54 or higher.
- Properly perform the wiring after confirming the signal names of all the terminals.
- Do not operate the control system until 2 seconds or more (2.2 seconds or more in case of series connection) after turning ON the power of the F3SJ.
- Be sure to route the F3SJ cable separate from high-potential power lines or through an exclusive conduit.
- When using a commercially available switching regulator power supply, make sure to ground the FG terminal (frame ground terminal).
- Install the emitter and receiver so that their vertical direction should match.

- If the protective height is 600 mm or more, use intermediate mounting brackets of specified quantities and locations according to the dimensions.
- If the brackets described above are not used, ratings and performance cannot be met.
- Sharing the power supply with other devices may cause the F3SJ to be affected by noise or voltage drop. It is recommended that the F3SJ use a dedicated power supply but do not share with other devices.

- **Cleaning**
Do not use thinner, benzene, or acetone for cleaning, because they affect the product's resin parts and paint on the case.
- **Object detection**
The F3SJ cannot detect transparent and/or translucent objects.

RATINGS

■ Ratings/Specifications

In the type names in this table, the □□□□ contain the 4 digits indicating the protective height (mm).

	F3SJ-A□□□□N14	F3SJ-A□□□□N20	F3SJ-A□□□□N25	F3SJ-A□□□□N30	F3SJ-A□□□□N55
Detection capability	Opaque objects	Opaque objects	Opaque objects	Opaque objects	Opaque objects
	Diameter 14mm	Diameter 20mm	Diameter 25mm	Diameter 30mm	Diameter 55mm
Beam gap	9mm	15mm	20mm	25mm	50mm
Number of beams	26 to 234	16 to 166	13 to 125	10 to 100	6 to 50
Protective height	245 to 2,117mm	245 to 2,495mm	260 to 2,500mm	245 to 2,495mm	270 to 2,470mm
Lens diameter	Diameter 5mm				
Operating range	0.2 to 9m (for protective height up to 1649 mm) 0.2 to 7m (for protective height 1655 mm or greater) (Operating range can be reduced to 0.5m through the setting tool)				
Response time	ON to OFF: 10ms to 27.5ms max., OFF to ON: 40ms to 110ms max. (when incidence is stable). Refer to the reverse side for details.				
Startup waiting time	2s max. (2.2s max in case of series connection)				
Power supply voltage(Vs)	24VDC ±20% (ripple p-p10% max.)				
Current consumption (no load)	Emitter	Up to 50 beams: 76 mA max., 51 to 100 beams: 106 mA max., 101 to 150 beams: 130 mA max., 151 to 200 beams: 153 mA max., 201 to 234 beams: 165 mA max.			
	Receiver	Up to 50 beams: 68 mA max., 51 to 100 beams: 90 mA max., 101 to 150 beams: 111 mA max., 151 to 200 beams: 128 mA max., 201 to 234 beams: 142 mA max.			
Light source	Infrared LED (870nm wavelength)				
Effective aperture angle (EAA)	Within ±2.5° for the emitter and receiver at a detection distance of at least 3 m according to IEC61496-2				
Safety outputs(OSSD)	NPN transistor outputs x 2. Load current 300mA max. Residual voltage 2V max. (except for voltage drop due to cable extension)(including inductance load). Maximum capacity load 2.2 μF. Leakage current 2 mA max. (This may be different from previously used logic (ON/OFF) because safety circuit is used.)				
Auxiliary output 1 (Non-safety output)	NPN transistor output x 1, Load current 300mA max., Residual voltage 2V max. (except for voltage drop due to cable extension), Leakage current 1mA max.				
Auxiliary output 2 (non-safety output, a function for a basic system)	NPN transistor output x 1, Load current 50mA or less, Residual voltage 2V or less (excluding influence by cable extension), Leakage current 1mA or less				
External indicator output (Non-safety output)	Connectable external indicator - Incandescent lamp : 24VDC, 3 to 7W - LED lamp : Load current 10 to 300mA max. Leakage current 1mA max.(An indicator cable F39-JJ3N or F39-A01P*PAC is required when using an external indicator.)				
Output operation mode	Safety outputs : ON when receiving light Auxiliary output 1 : Reverse output of safety output (operation mode can be changed by the setting tool) Auxiliary output 2: Turns ON when 30,000 hours of power-on time passes (operation mode can be changed by the setting tool) External indicator output 1: Reverse output of safety output (for basic system), ON during muting/override (for muting system) (Operation mode can be changed by the setting tool) External indicator output 2: ON in lockout (for basic system), ON during muting/override (for muting system) (operation mode can be changed by the setting tool)				
Input voltage	Test input, Interlock select input, Reset input, Muting input: ON voltage: 0 to 1.5V (short-circuit current 1.5mA max.) OFF voltage: 9V to Vs*, or open External device monitoring input is: ON voltage: 0 to 1.5V (short-circuit current 4.0mA max.) OFF voltage: open *The Vs indicates a voltage value in your environment.				
Indicators	Emitter	Incident light level indicators (green LED x 2, orange LED x 3): ON based on the amount of incident light Error mode indicators (red LED x 3): Blink to indicate error details Power indicator (green LED x 1): ON while power is ON Interlock indicator (yellow LED x 1): ON when in interlock/blinks when in lockout External device monitoring indicator [muting input 1 indicator], Blanking/ Test indicator [muting input 2 indicator] (green LED x2): ON/Blink according to function			
	Receiver	Incident light level indicators (green LED x 2, orange LED x 3): ON based on the amount of incident light Error mode indicators (red LED x 3): Blink to indicate error details OFF-state indicator (red LED x 1): ON when safety outputs are OFF/ Blinks when in lockout ON-state indicator (green LED x 1): ON when safety outputs are ON Muting error indicator, Blanking/Test indicator (green LED x 2): ON/Blink according to function			
Mutual interference prevention function	Interference light avoidance algorithm, Operating range change function				
Series connection	Time division emission by series connection - Number of connections: Up to 4 sets - Total number of beams: Up to 400 - Cable length between sensors: 15 m max. (not including series connection cable (F39-JJR□□ or F39-JJR3W) and power cable)				
Test function	- Self-test (After power ON, and during operation) - External test (light emission stop function by test input)				
Safety-related functions	- Start interlock, restart interlock (The setting tool is required when muting function is used) - External device monitoring - Muting (Includes lamp breakage detection and override functions. F39-CN6 key cap for muting is required) - Fixed blanking (configuration by the setting tool is required) - Floating blanking (configuration by the setting tool is required)				
Connection method	Connector method (M12, 8-pin)				
Protection circuit	Output short-circuit protection, and power supply reverse polarity protection				
Ambient temperature	During operation: -10 to 55°C (without freezing), During storage: -30 to 70°C				
Ambient humidity	During operation: 35 to 85%RH (no condensation), During storage: 35 to 95%RH				
Ambient light intensity	Incandescent lamp: receiving-surface light intensity of 3,000 lx max., Sunlight: receiving-surface light intensity of 10,000 lx max.				
Insulation resistance	20MΩ or higher (500VDC)				
Dielectric strength voltage	1,000VAC, 50/60Hz, 1min				
Degree of protection	IP65 (IEC60529)				
Vibration resistance	Class 3M4 (IEC TR 60721-4-3) Operation limit: 5-150 Hz, Multiple amplitude of 7 mm, Acceleration of 1G, 10 sweeps each in X, Y, and Z directions (no delay at resonant frequencies)				
Shock resistance	Class 3M4 (IEC TR 60721-4-3) Operation limit: Acceleration of 15G, Pulse duration of 6 ms, 100 shocks for each in X, Y, and Z directions (600 shocks in total)				
Connection cable, Series connection cable (F39-JJR□□, JJR3W)	Dia. 6 mm, 8-wire (0.15mm ² x 8) with braided shield, Allowable bending radius R5mm				
Extension cable (F39-JD□□, F39-JD□□B)	Dia. 6.6 mm, 8-wire (0.3mm ² x 4P, conductor resistance 0.058 Ω/m), with braided shield, Allowable bending radius of R36mm. (To extend a cable, use an equivalent or higher-performance cable (twisted-pair wire) , and do not use the cable in the same duct as that for high-voltage cables or power cables) For details about extension lengths (Power Cable Length), refer to next page				
Material	Casing (including metal parts on both ends): Aluminum, zinc die-cast Cap: ABS resin Optical cover: PMMA resin (acrylic) Cable: Oil resistant PVC				
Weight (net)	- F3SJ-A□□□□N14 Weight (g)=(protective height) x 1.67+215 - F3SJ-A□□□□N20 Weight (g)=(protective height) x 1.5+217 - F3SJ-A□□□□N25 Weight (g)=(protective height) x 1.45+219 - F3SJ-A□□□□N30 Weight (g)=(protective height) x 1.41+220 - F3SJ-A□□□□N55 Weight (g)=(protective height) x 1.3+220				
Weight (packaged)	- F3SJ-A□□□□N14 Weight (g)=(protective height) x 1.7+ α - F3SJ-A□□□□N20/F3SJ-A□□□□N25/F3SJ-A□□□□N30 Weight (g)=(protective height) x 1.5+ α - F3SJ-A□□□□N55 Weight (g)=(protective height) x 1.4+ α The values for α are as follows: When protective heights between 245 and 596mm, α=1100 When protective heights between 600 and 1130mm, α=1500 When protective heights between 1136 and 1658mm, α=2000 When protective heights between 1660 and 2180mm, α=2400 When protective heights between 2195 and 2500mm, α=2600				
Accessories	Instruction sheet, top and bottom mounting brackets, intermediate mounting brackets (*1), error mode label, Quick Installation Manual (QIM) *1 The number of intermediate mounting brackets depends on the total length of the F3SJ. - F3SJ total length is from 600 to 1,130mm: 1 set for each the emitter and receiver is included - F3SJ total length is from 1136 to 1,658mm: 2 sets for each the emitter and receiver are included - F3SJ total length is from 1660 to 2,180mm: 3 sets for each the emitter and receiver are included - F3SJ total length is from 2195 to 2500mm: 4 sets for each the emitter and receiver are included				
Applicable standards	IEC61496-1, EN61496-1, UL61496-1 Type 4ESPE (Electro-Sensitive Protective Equipment) IEC61496-2, EN61496-2, UL61496-2 Type 4AOPD (Active Opto-electronic Protective Devices) IEC61508, EN61508 SIL3, EN ISO 13849-1:2015 (Category 4, PL e), ISO 13849-1:2015 (Category 4, PL e)				

OMRON Corporation (Manufacturer)

Shioikoji Horikawa, Shimogyo-ku, Kyoto, 600-8530 JAPAN

Contact: www.ia.omron.com

Regional Headquarters

- **OMRON EUROPE B.V.** (Importer in EU)
Weglaan 67-69, 2132 JD Hoofddorp
The Netherlands
Tel: (31)2356-81-300/Fax: (31)2356-81-388
- **OMRON ELECTRONICS LLC**
2895 Greenspoint Parkway, Suite 200
Hoffman Estates, IL 60169 U.S.A.
Tel: (1) 847-843-7900/Fax: (1) 847-843-7787
- **OMRON ASIA PACIFIC PTE. LTD.**
No. 433A, Alexandra Road # 05-05/08 (Lobby 2),
Alexandra Technopark,
Singapore 119667
Tel: (65) 6835-3011/Fax: (65) 6835-2711
- **OMRON (CHINA) CO., LTD.**
Room 2211, Bank of China Tower,
200 Yixiang Zhong Road,
PuDong New Area, Shanghai, 200120, China
Tel: (86) 21-5037-2222/Fax: (86) 21-5037-2200

F © Apr. 2021

Wiring Diagrams

[Basic System]

Wiring using manual reset mode, external device monitoring

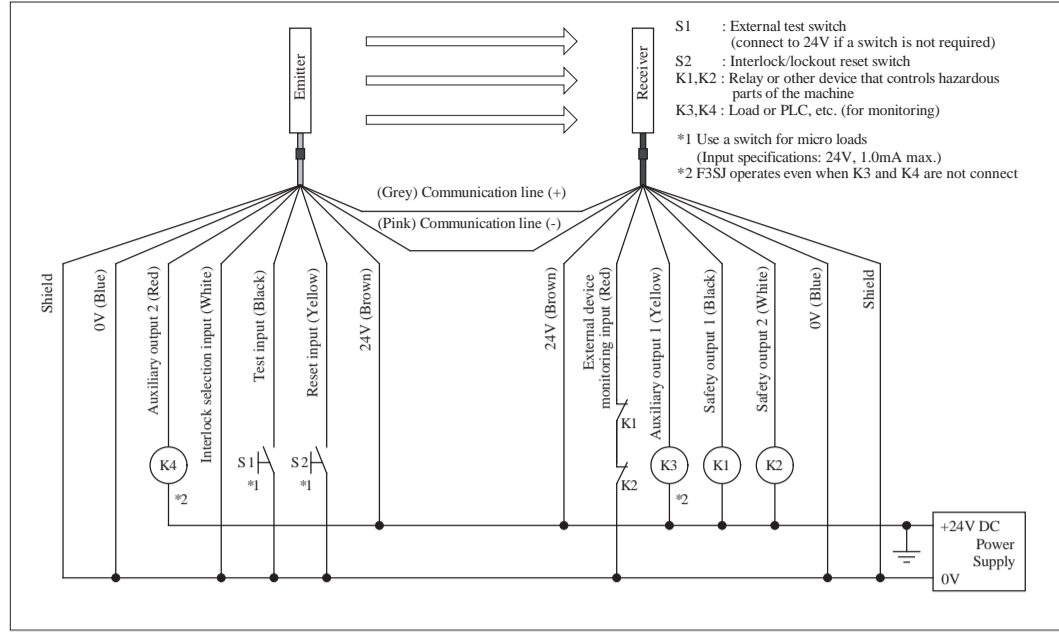

Wiring for auto reset mode

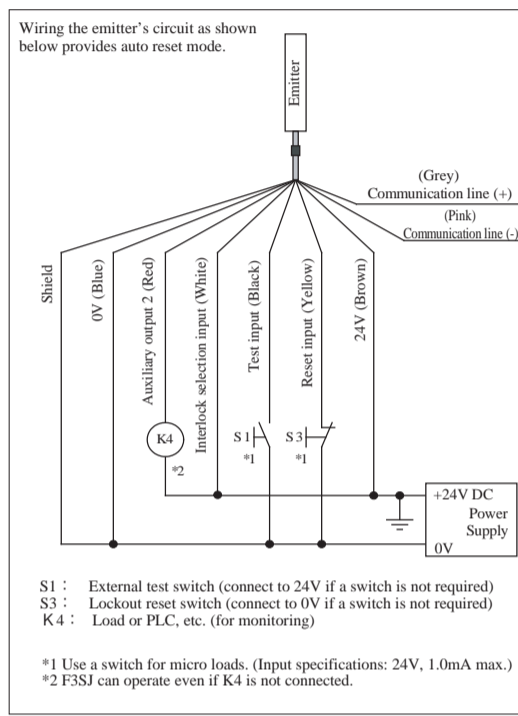

Wiring when external device monitoring function is not used

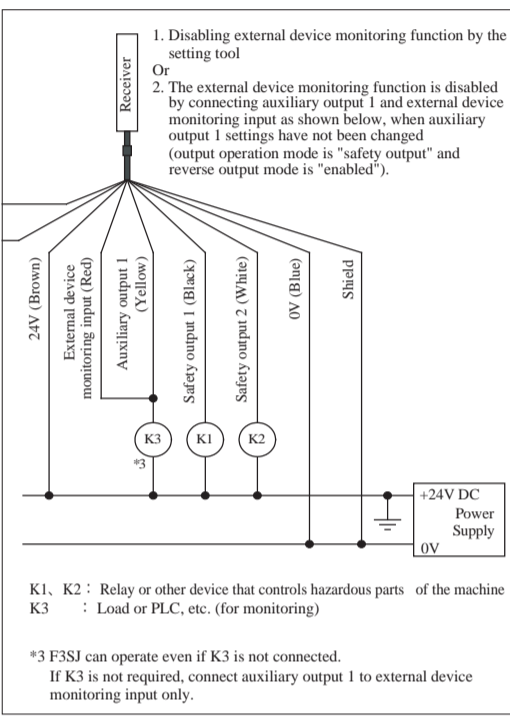

[Muting System]

Wiring when using muting and external device monitoring functions

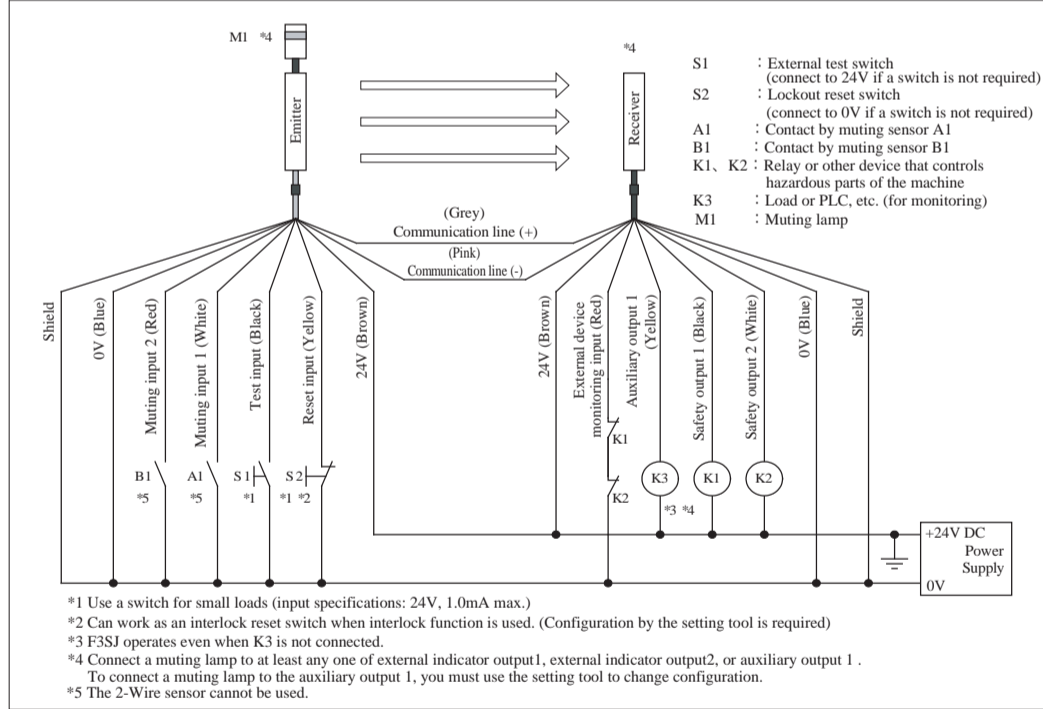

Wiring when external device monitoring function is not required

Wiring diagram is the same as that for "Wiring when external device monitoring function is not used" of the basic system.

Input/Output Circuit

Input/output circuit

The numbers in white circles indicate the connector's pin numbers.
 The black circles indicate connectors for series connection.
 The words in brackets [] indicate the signal name for muting system.

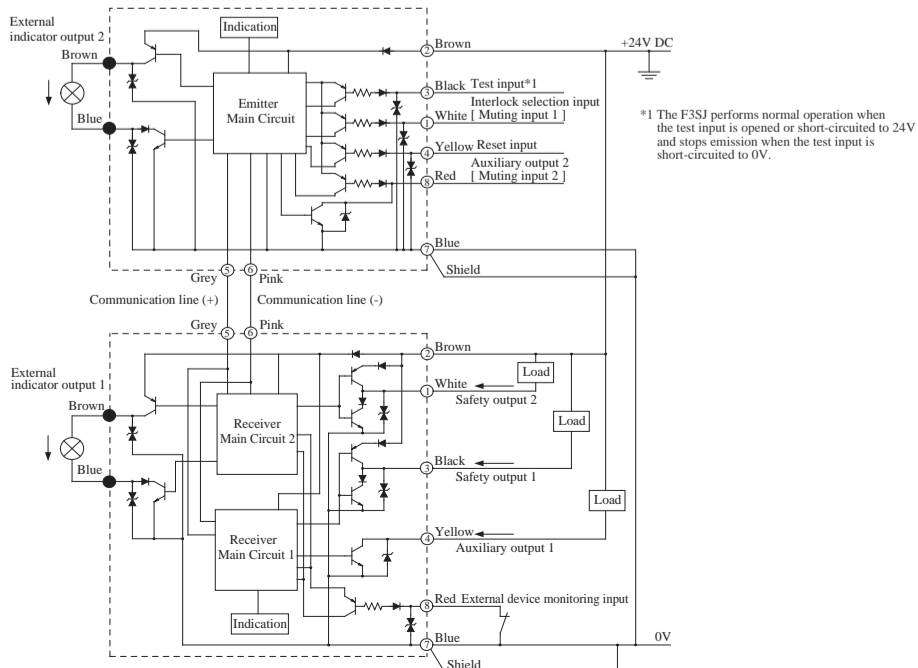

Indicator Display Patterns

Indicators

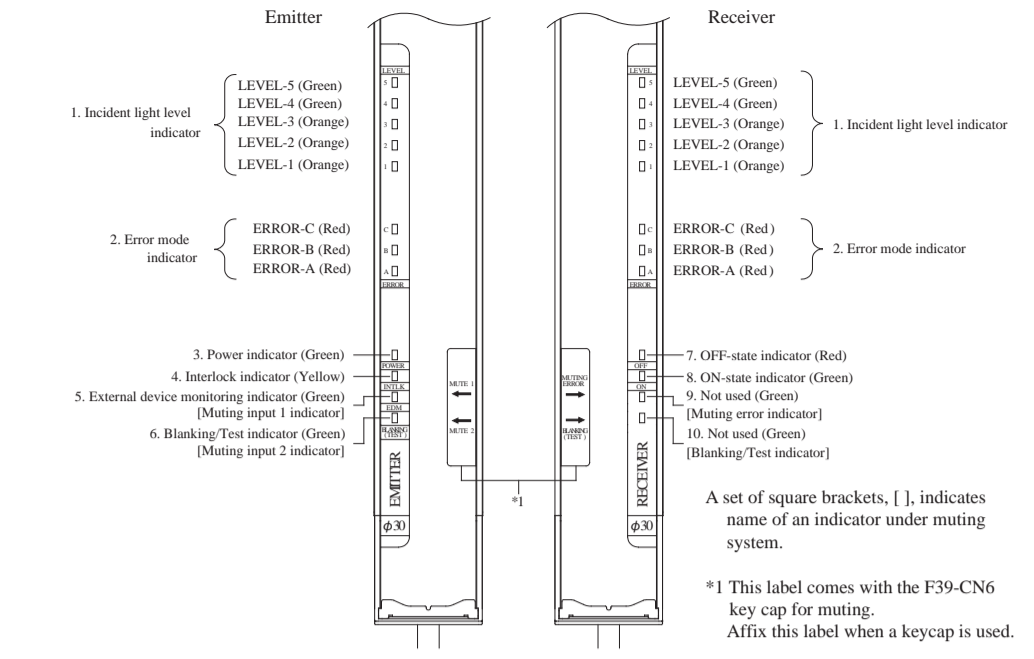

Indicator display patterns for a basic system

No.	Indicators	ON/Blinking	Description	
1	Incident light level indicator	LEVEL-1 to 5	ON	Indication status of LEVEL-1 to 5 shows the incident light level status of the F3SJ.
2	Error mode indicator	ERROR-A to C	ON/Blinking	Turns ON or blinks only when the F3SJ enters lockout, and the cause of the error is indicated by the status of ERROR-A to C indicators. When F3SJ are series-connected, the error mode indicator lamps turn ON or blink according to the details of each error. Affix the error mode label (included) near the F3SJ to allow for quick trouble shooting when errors occur. For details about error mode, refer to " ■ Indication patterns of error mode indicator".
3	Power indicator	POWER	ON	Turns ON while the power is ON.
4	Interlock indicator	INTLK	ON	Turns ON when F3SJ is in interlock state.
5	External device monitoring indicator	EDM	ON	Turns ON when an input is given to external device monitoring input.
6	Blanking/Test indicator	BLANKING /TEST	ON	Turns ON when the blanking function and warning zone function are enabled.
7	OFF-state indicator	OFF	ON	Turns ON when safety outputs are OFF.
8	ON-state indicator	ON	ON	Turns ON when safety outputs are ON.
9	—	—	—	—
10	—	—	—	—

Indicator display patterns for a muting system (Indicator display different from a basic system are described.)

No.	Indicators	ON/Blinking	Description	
5	Muting input 1 indicator	MUTE1	ON	Turns ON when an input is given to muting input 1.
6	Muting input 2 indicator	MUTE2	ON	Turns ON when an input is given to muting input 2.
9	Muting error indicator	MUTING ERROR	ON	Turns ON during a muting error.
10	Blanking/Test indicator	BLANKING /TEST	ON	Turns ON when the blanking function is enabled.

Indication patterns of the incident light level indicator

ON	OFF	Incident light level
ON	OFF	170% or higher of safety output ON level
ON	OFF	From 130 to less than 170% of safety output ON level
ON	OFF	From 100 to less than 130% of safety output ON level
ON	OFF	From 75 to less than 100% of safety output ON level
ON	OFF	From 50 to less than 75% of safety output ON level
ON	OFF	Less than 50% of safety output ON level

Operation is possible with incident light level of 100% or more, but to ensure stability, operate when all incident light level indicators

Indication patterns of error mode indicator

A	B	C	Main cause of error
ON	OFF	OFF	Mutual interference or disturbance light.
ON	OFF	OFF	Power supply voltage of F3SJ is out of rated range. Insufficient current capacity of power supply.
ON	OFF	OFF	Light incidence to a blanking beam.
ON	OFF	OFF	Breakage, incorrect wiring of communication line, disconnection of series-connection cable, influence of noise, or other errors.
ON	OFF	OFF	The models of the emitter and receiver in a set are different.
ON	OFF	OFF	Function setting value configured by the setting tool is out of valid range.
ON	OFF	OFF	End cap is not attached. Failure of internal circuit of F3SJ.
ON	OFF	OFF	Relay is welded or recovery time is too long. Incorrect wiring or breakage of external device monitoring line.
ON	OFF	OFF	Incorrect wiring or breakage of interlock selection input line or reset input line.
ON	OFF	OFF	Incorrect wiring or breakage of reset input line for a muting system.
ON	OFF	OFF	Incorrect wiring of safety output 1 or 2. Failure of safety output circuit.
ON	OFF	OFF	Incorrect wiring or breakage of series-connection cable.
ON	OFF	OFF	Incorrect wiring or circuit breakage of external indicator output.
ON	OFF	OFF	Auxiliary output 1 is detached or broken.
ON	OFF	OFF	Broken series connection cable.
ON	OFF	OFF	Incorrect wiring or breakage of communication line.
ON	OFF	OFF	Effect of noise. F3SJ Failure of internal circuit.

Refer to F3SJ User's manual for details.

Response Times / Power Cable Length

Response times

Protective height [mm]	Number of beams	Response time (ON to OFF) [ms]	Response time (OFF to ON) [ms]
245~272	26~29	11	44
281~389	30~42	12	48
398~506	43~55	13	52
515~614	56~67	14	56
623~731	68~80	15	60
740~1019	81~112	17.5	70
1028~1307	113~144	20	80
1316~1595	145~176	22.5	90
1604~1883	177~208	25	100
1892~2117	209~234	27.5	110

Protective height [mm]	Number of beams	Response time (ON to OFF) [ms]	Response time (OFF to ON) [ms]
260~320	13~16	10	40
340~580	17~29	11	44
600~840	30~42	12	48
860~1100	43~55	13	52
1120~1340	56~67	14	56
1360~1600	68~80	15	60
1620~2240	81~112	17.5	70
2260~2500	113~125	20	80

Protective height [mm]	Number of beams	Response time (ON to OFF) [ms]	Response time (OFF to ON) [ms]
270~770	6~16	10	40
820~1420	17~29	11	44
1470~2070	30~42	12	48
2120~2470	43~50	13	52

Power cable length

Extension of power cable must be the length shown below or shorter:

Condition	Single	2 connected	3 connected	4 connected
Incandescent display lamps are used by auxiliary output and/or external indicator output	45m	40m	30m	20m
Incandescent display lamps are not used*	100m	60m	45m	30m

*The F39-A01P□-PAC Dedicated External Indicator Set uses LEDs. Refer to the cable extension lengths for "Incandescent display lamps are not used".

F3SJ-A□□□□N20

Protective height [mm]	Number of beams	Response time (ON to OFF) [ms]	Response time (OFF to ON) [ms]
245	16	10	40
260~440	17~29	11	44
455~635	30~42	12	48
650~830	43~55	13	52
845~1010	56~67	14	56
1025~1205	68~80	15	60
1220~1685	81~112	17.5	70
1700~2165	113~144	20	80
2180~2495	145~166	22.5	90

Protective height [mm]	Number of beams	Response time (ON to OFF) [ms]	Response time (OFF to ON) [ms]
245~395	10~16	10	40
420~720	17~29	11	44
745~1045	30~42	12	48
1070~1370	43~55	13	52
1395~1670	56~67	14	56
1695~1995	68~80	15	60
2020~2495	81~100	17.5	70

For series connections, use the calculations below.
 When 2 sets are series-connected
 Response time (ON to OFF):
 Response time of 1st unit + Response time of 2nd unit - 1 (ms)
 Response time (OFF to ON):
 Response time from the above calculation x 4 (ms)

When 3 sets are series-connected
 Response time (ON to OFF):
 Response time of 1st unit + Response time of 2nd unit + Response time of 3rd unit - 5 (ms)
 Response time (OFF to ON):
 Response time from the above calculation x 5 (ms)

When 4 sets are series-connected
 Response time (ON to OFF):
 Response time of 1st unit + Response time of 2nd unit + Response time of 3rd unit + Response time of 4th unit - 8 (ms)
 Response time (OFF to ON):
 Response time from the above calculation x 5 (ms)