

Fiber Laser Marker

MX-Z2000H-V1 series

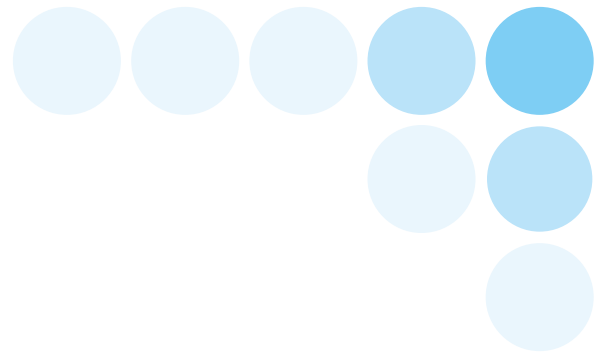

User's manual



Introduction

Thank you for purchasing Fiber Laser Marker MX-Z2000H-V1 series.

This manual describes the functions, performance, how to use and other information you need to know to use the MX-Z2000H-V1 series.

Take heed of the following when using the MX-Z2000H-V1 series:

- The MX-Z2000H-V1 series should be handled by experts with knowledge of electrical engineering.
- Read this manual carefully and understand the content fully to ensure the correct use.
- Keep this manual in good care so that it can be referenced at any time.

●Registered trademark

- Microsoft and Windows are registered trademarks or trademarks of Microsoft Corporation in the United States and other countries.
- QR Code and Micro QR Code are registered trademark of DENSO WAVE INCORPORATED.
- EtherNet/IP is a trademark of ODVA.
- Other company names and product names mentioned herein may be registered trademarks or trademarks of their respective owners and are hereby acknowledged.

●Types and purposes of manuals

The main content of the manuals are below. Select and read the manual that meets your specific purpose.

Instruction sheet

This manual provides basic information you need to know to use safely and correctly this product. And it primarily covers the information contained in the setup manual including the explanation of installation/connection and basic operating procedures.

Manuals contained in the CD-ROM (PDF files)

Setup manual (Japanese, English)

User's manual (Japanese, English)

Information including how to install software and how to use the Font logo editor is provided.

Note

Adobe Reader® by Adobe® must be installed to view the Manual (PDF file).
Download it from Adobe®'s website.

Terms and Conditions Agreement

Warranties.

- (a) Exclusive Warranty. Omron's exclusive warranty is that the Products will be free from defects in materials and workmanship for a period of twelve months from the date of sale by Omron (or such other period expressed in writing by Omron). Omron disclaims all other warranties, express or implied.
- (b) Limitations. OMRON MAKES NO WARRANTY OR REPRESENTATION, EXPRESS OR IMPLIED, ABOUT NONINFRINGEMENT, MERCHANTABILITY OR FITNESS FOR A PARTICULAR PURPOSE OF THE PRODUCTS. BUYER ACKNOWLEDGES THAT IT ALONE HAS DETERMINED THAT THE PRODUCTS WILL SUITABLY MEET THE REQUIREMENTS OF THEIR INTENDED USE.

Omron further disclaims all warranties and responsibility of any type for claims or expenses based on infringement by the Products or otherwise of any intellectual property right.

- (c) Buyer Remedy. Omron's sole obligation hereunder shall be, at Omron's election, to (i) replace (in the form originally shipped with Buyer responsible for labor charges for removal or replacement thereof) the non-complying Product, (ii) repair the noncomplying Product, or (iii) repay or credit Buyer an amount equal to the purchase price of the non-complying Product; provided that in no event shall Omron be responsible for warranty, repair, indemnity or any other claims or expenses regarding the Products unless Omron's analysis confirms that the Products were properly handled, stored, installed and maintained and not subject to contamination, abuse, misuse or inappropriate modification. Return of any Products by Buyer must be approved in writing by Omron before shipment. Omron Companies shall not be liable for the suitability or unsuitability or the results from the use of Products in combination with any electrical or electronic components, circuits, system assemblies or any other materials or substances or environments. Any advice, recommendations or information given orally or in writing, are not to be construed as an amendment or addition to the above warranty.

See <http://www.omron.com/global/> or contact your Omron representative for published information.

Limitation on Liability; Etc.

OMRON COMPANIES SHALL NOT BE LIABLE FOR SPECIAL, INDIRECT, INCIDENTAL, OR CONSEQUENTIAL DAMAGES, LOSS OF PROFITS OR PRODUCTION OR COMMERCIAL LOSS IN ANY WAY CONNECTED WITH THE PRODUCTS, WHETHER SUCH CLAIM IS BASED IN CONTRACT, WARRANTY, NEGLIGENCE OR STRICT LIABILITY.

Further, in no event shall liability of Omron Companies exceed the individual price of the Product on which liability is asserted.

Suitability of Use.

Omron Companies shall not be responsible for conformity with any standards, codes or regulations which apply to the combination of the Product in the Buyer's application or use of the Product. At Buyer's request, Omron will provide applicable third party certification documents identifying ratings and limitations of use which apply to the Product. This information by itself is not sufficient for a complete determination of the suitability of the Product in combination with the end product, machine, system, or other application or use. Buyer shall be solely responsible for determining appropriateness of the particular Product with respect to Buyer's application, product or system. Buyer shall take application responsibility in all cases.

NEVER USE THE PRODUCT FOR AN APPLICATION INVOLVING SERIOUS RISK TO LIFE OR PROPERTY WITHOUT ENSURING THAT THE SYSTEM AS A WHOLE HAS BEEN DESIGNED TO ADDRESS THE RISKS, AND THAT THE OMRON PRODUCT(S) IS PROPERLY RATED AND INSTALLED FOR THE INTENDED USE WITHIN THE OVERALL EQUIPMENT OR SYSTEM.

Omron assumes absolutely no liability for any losses or damages incurred either directly or indirectly along with any associated costs that may be incurred to Omron products, installed software or any computer equipment, computer programs, networks or databases that may be infected as a result of a DDoS (distributed denial of service) attack, a computer virus or some other technically harmful program, or from unauthorized access.

We ask that you take sufficient measures including (1) anti-virus protection, (2) data input/output, (3) restoring any lost data, (4) preventing the spread of computer viruses to Omron products or to the software installed on them, and (5) preventing unwanted access to Omron products.

Programmable Products.

Omron Companies shall not be responsible for the user's programming of a programmable Product, or any consequence thereof.

Performance Data.

Data presented in Omron Company websites, catalogs and other materials is provided as a guide for the user in determining suitability and does not constitute a warranty. It may represent the result of Omron's test conditions, and the user must correlate it to actual application requirements. Actual performance is subject to the Omron's Warranty and Limitations of Liability.

Change in Specifications.

Product specifications and accessories may be changed at any time based on improvements and other reasons. It is our practice to change part numbers when published ratings or features are changed, or when significant construction changes are made. However, some specifications of the Product may be changed without any notice. When in doubt, special part numbers may be assigned to fix or establish key specifications for your application. Please consult with your Omron's representative at any time to confirm actual specifications of purchased Product.

Errors and Omissions.

Information presented by Omron Companies has been checked and is believed to be accurate; however, no responsibility is assumed for clerical, typographical or proofreading errors or omissions.

Notes on Safety

● Safety Labels and Definitions

In this manual, the precautions are indicated with the following labels and symbols so that MX-Z2000H-V1 series can be used safely. The precautions described here contain information critical to ensuring safety. Be sure to observe them. The labels and symbols are as follows.

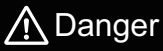

Danger

Improper handling will lead to a hazardous situation where a death or serious injury may result. It may also result in serious property damage.



Warning

Improper handling will lead to a hazardous situation where a minor or moderate injury or, in the worst case, serious injury or death may result. It may also result in critical property damage.



Caution

Improper handling will lead to a hazardous situation where a minor or moderate injury, or property damage may result.

● Meaning of Graphic Symbols

	<ul style="list-style-type: none"> ● Laser beam <p>Indicates a possibility of injury or damage due to laser beam.</p>
	<ul style="list-style-type: none"> ● Caution for electric shock <p>Indicates a possibility of electric shock in certain conditions.</p>
	<ul style="list-style-type: none"> ● Prohibited <p>Indicates a prohibition in general.</p>
	<ul style="list-style-type: none"> ● Caution for explosion <p>Indicates a possibility of explosion in certain conditions.</p>
	<ul style="list-style-type: none"> ● Wear protective glasses <p>Indicates a situation that requires eye guard to be worn.</p>
	<ul style="list-style-type: none"> ● Contact prohibited <p>Indicates a possibility of injury caused by touching a certain part of the device in certain conditions.</p>
	<ul style="list-style-type: none"> ● Execute <p>Indicates an action of a non-specific, general user.</p>
	<ul style="list-style-type: none"> ● Always connect a grounding wire. <p>Indicates an instruction to the user to always connect a grounding wire when using a device with a safety ground terminal.</p>
	<ul style="list-style-type: none"> ● Disassembly prohibited <p>Indicates that disassembly of the device is prohibited as doing so may cause an electric shock or other injury.</p>
	<ul style="list-style-type: none"> ● Caution for high temperature <p>Indicates a possibility of injury due to high temperature in certain conditions.</p>



● Caution for falling

Indicates a possibility of falling due to strongly pushing and pulling certain parts of the device.

● Warning display

 **Danger**

A serious personal injury may result.

Do not operate the product unless you have received laser safety training or operation training, or have understood the content of this manual.

Set up the laser controlled area and enclose the laser irradiation area with a shield so that the laser emission does not exceed the class 1 (IEC 60825-1, JIS C6802) level.



A serious personal injury may result.

Voltage is applied to some parts inside the product. Do not touch the inside of the product.



A serious personal injury may result.

When you must touch the electrical system of the product for maintenance or cleaning, disconnect the controller power supply cable of the main unit from the outlet and wait for at least 10 minutes, and then make sure, using a tester, that there is no residual voltage.



A serious personal injury may result in some extreme circumstances.

Do not have your hand or any other body part come close to the laser emission port.

Furthermore, never open the head cover because the extremely strong, near-infrared laser beam, which is invisible to the eye, is being emitted inside the marker head.



A serious personal injury may result in some circumstances.

Construct an interlock system with which the laser stops when the laser safety gate is opened.



 **Warning**

A serious personal injury may result in some extreme circumstances.

Do not disassemble the product or modify the inside parts for purposes other than the specified maintenance.



A serious personal injury may result in some extreme circumstances.

Always turn off the power supply before wiring, installing, or performing maintenance on the product.

Be sure to observe the instructions for connections in the manual.



A serious personal injury may result in some extreme circumstances.

Install the product in a location that is as bright as possible. Since the diameter of pupil is larger in a dark place, laser beam may cause an even more serious injury if it were to hit the eye.



A serious personal injury may result in some extreme circumstances.

Do not place a highly reflective object with a smooth surface near the laser beam path.



A serious personal injury may result in some extreme circumstances.

Do not place a flammable or combustible object around the product or near the laser beam path.













Smoke generating or igniting accident may result.









A serious personal injury may result in some extreme circumstances.

Never forcibly continue to operate the product when an error or failure occurs as doing so may result in smoke generating or igniting accident.













<p>A serious personal injury may result in some extreme circumstances. If you feel a sense of danger due to abnormal behavior or noise while operating the product, do not hesitate to press the emergency stop switch ([EMERGENCY] button) and turn off the power supply to the product.</p>	
<p>A serious personal injury may result in some extreme circumstances. Never +/- short-circuit, charge, disassemble, change the shape by pressure, or put in fire a button battery.</p>	
<p>A serious personal injury may result in some extreme circumstances. Never put a metal object through the opening of the case.</p>	
<p>A serious personal injury may result in some extreme circumstances. Never put a finger through the opening of the case.</p>	
<p>A serious personal injury may result in some extreme circumstances. Terminate the laser beam path with a reflecting diffuser or absorber with appropriate reflectance and heat characteristic. Do not install the marker head at the height of the eye. Usage other than specified within this manual is prohibited. There is risk of radiation exposure from the laser beam.</p>	
<p>A serious personal injury may result in some extreme circumstances. Use the dedicated software installed on the main unit.</p>	
<p>A serious personal injury may result in some extreme circumstances. Deposits of dust generated during processing may result in smoke or ignition at a low temperature. Install a suction duct to prevent dust from accumulating. Do not store the product in a dusty area.</p>	
<p>A serious personal injury may result in some extreme circumstances. Never disconnect the marker head, the controller and the fiber cable. Stop the use of the product if any of them is disconnected. The product will need to be collected and repaired by OMRON.</p>	
<p>A serious personal injury may result in some circumstances. Always reset the error manually.</p>	
<p>A serious personal injury may result in some circumstances. Sufficiently purify and discharge the gases generated during processing.</p>	
<p>A serious personal injury may result. Unauthorized operation of the product by a person who has not received laser safety training may, in rare cases, result in an injury or other personal accident. Be sure to have the laser safety manager manage the key switches.</p>	
<p>A serious personal injury may result. Any procedures or adjustments made outside of those specified in this manual may cause exposure to dangerous laser radiation. This product must be controlled and operated using the procedures specified in this manual.</p>	
<p>A serious personal injury may result. Wear protective glasses when emitting laser beam. Laser beam, if it hits the eye, may cause blindness. Do not look into it.</p>	

Security Measures

Anti-virus protection Install the latest commercial-quality antivirus software on the computer connected to the control system and maintain to keep the software up-to-date.	
Security measures to prevent unauthorized access Take the following measures to prevent unauthorized access to our products. <ul style="list-style-type: none">• Install physical controls so that only authorized personnel can access control systems and equipment.• Reduce connections to control systems and equipment via networks to prevent access from untrusted devices.• Install firewalls to shut down unused communications ports and limit communications hosts and isolate control systems and equipment from the IT network.• Use a virtual private network (VPN) for remote access to control systems and equipment.• Adopt multifactor authentication to devices with remote access to control systems and equipment.• Set strong passwords and change them frequently.• Scan virus to ensure safety of USB drives or other external storages before connecting them to control systems and equipment.	
Data input and output protection Validate backups and ranges to cope with unintentional modification of input/output data to control systems and equipment. <ul style="list-style-type: none">• Checking the scope of data• Checking validity of backups and preparing data for restore in case of falsification and abnormalities• Safety design, such as emergency shutdown and fail-soft operation in case of data tampering and abnormalities	
Data recovery Backup data and keep the data up-to-date periodically to prepare for data loss.	
When using an intranet environment through a global address, connecting to a SCADA or an unauthorized terminal such as an HMI or to an unauthorized server may result in network security issues such as spoofing and tampering. You must take sufficient measures such as restricting access to the terminal, using a terminal equipped with a secure function, and locking the installation area by yourself.	
When constructing an intranet, communication failure may occur due to cable disconnection or the influence of unauthorized network equipment. Take adequate measures, such as restricting physical access to network devices, by means such as locking the installation area.	
When using a device equipped with the SD Memory Card function, there is a security risk that a third party may acquire, alter, or replace the files and data in the removable media by removing the removable media or unmounting the removable media. Please take sufficient measures, such as restricting physical access to the Controller or taking appropriate management measures for removable media, by means of locking the installation area, entrance management, etc., by yourself.	

 Caution

<p>In rare cases, property damage may result. When using the product, be sure to observe the installation conditions and provide necessary space for it.</p>	
<p>Do not use the product in any of the following environments as the product may, in rare cases, be damaged.</p> <ul style="list-style-type: none">(a) Dusty area(b) Area with oil mist floating in the air(c) Area subject to impact or vibration(d) Area with high humidity (of 85% RH or higher)(e) Wet floor surface(f) Installation on a table other than an affixed frame (movable part) <p>Securely tighten the marker head with screws and provide appropriate amount of space.</p>	
<p>In rare cases, the product may be damaged. Be sure to conduct periodic inspections to maintain the level of product performance and to ensure safety.</p>	
<p>In rare cases, property damage may result. Do not bend the optical fiber cable to a radius of 100 mm or less, or apply excessive load or impact to it. Do not move the marker head by holding or pulling the fiber cable.</p>	
<p>Touching it may, in rare cases, cause a burn due to high heat. Do not touch while the power is being supplied or immediately after the power is turned off.</p>	
<p>In rare cases, the product may be damaged. Do not touch the cover glass with bare hands.</p>	
<p>Conducting maintenance in an unnatural posture may, in rare cases, result in an injury or other personal injury. Provide a space for maintenance when installing the product.</p>	
<p>A serious personal injury may result. Be sure that excessive force is not placed on the area above the caution label for falling on the side of the controller.</p>	
<p>When transporting the marker head, be sure to hold the concaved section in front and handle at the back with both hands.</p>	
<p>If the equipment is used in a manner not specified by the manufacturer, the protection provided by the equipment may be impaired.</p>	

Safety Points

Be sure to observe the following points that are necessary to ensure safety.

1. Usage

This product was developed and manufactured to be integrated with systems, machines, equipment and so on in an industrial environment. When using this product, follow all applicable standards, laws and regulations. Also, the customer is responsible for confirming the compatibility of the product.

2. Installation Location

Do not install the product in any of the following environments.

- Area with an ambient temperature that exceeds the rated range
- Area with sudden temperature shift (area where condensation can occur)
- Area with a humidity level that exceeds the 35 to 85% RH range
- Area subject to direct sunlight or near a heating appliance
- Area where a ferromagnetic field or an intense electric field is present
- Area where a carrier machine, etc. moves
- Area where corrosive gas or flammable gas is present
- Area where dust, salt, or iron powder is present
- Area where water, oil or chemical splashes or mist may be present

3. Power Supply, Connection and Wiring

- Do not use a voltage that exceeds the rated voltage or AC power source.
- Make the separate wiring for high-voltage line, power wire and power to the product. Using the same wire or duct will result in induction, which then may cause malfunction or damage.
- Use the dedicated cables that are specified in this document.
- Connect the controller power supply cable to a 3P outlet with grounding (D-class grounding). If a D-class grounding is not used, there is a risk of electric shock.
- Use SELV (Safety Extra Low Voltage) circuit for all external circuits connected to this product. SELV is an ungrounded circuit separated from dangerous voltage by double insulation or higher insulation, and it does not exceed safe voltage (peak 42.4 V or 60 V (DC)) even in single failure condition.



"Fiber Laser Marker MX-Z2000H-V1 series Setup Manual" (Z415)

4. Interlock

The product is equipped with the shutter interlock function. Use it for remote interlocks, etc.

Set the terminal of the input terminal block [EMERGENCY A] (emergency stop input A) or [EMERGENCY B] (emergency stop input B) to open (OPEN) to forcibly close the shutter inside the marker head and stop the laser emission.

When constructing an interlock system according to Category 3 indicated in International Standards ISO13849-1 (JIS B 9705-1) (classification of the safety-related parts of a control system in respect to their resistance to faults and their subsequent behavior under the fault condition), use the interlock terminal.



"Fiber Laser Marker MX-Z2000H-V1 series Setup Manual" (Z415)

5. Emission Direction

The product assumes laser emission in the downward direction. When setting the emission direction to a direction other than downward, at your own risk, please thoroughly implement safety measures, as well as protective measures to prevent dust from sticking to the cover glass.

6. Dust and Gas Generated during Marking

Dust or gas generated during marking can cause damage to the laser oscillator or the optical system. Be sure to protect the laser marker by collecting the dust or gas generated during marking.

When using a suction duct to suck in fine particles, such as metal, oxidized and carbide material, generated during marking, welding, cutting or other processes, use a duct with straight interior walls with which fine particles are hard to accumulate, and install the duct so that fine particles do not accumulate. Furthermore, periodically clean the inside of the duct to prevent fine particles from accumulating and to prevent a dust explosion.

7. Other

- Do not disassemble, repair, modify, change the shape by pressure, or incinerate this product.
- When disposing of the product, follow the instructions of the local government and other authorities and dispose of it as industrial waste.
- Connect the dedicated products (marker head, controller and cable). Use of non-dedicated products may lead to malfunction or failure.

- If you feel a sense of error, immediately stop using the product and turn off the power supply, and contact your OMRON representative.
- Do not move the product with the cable still attached.
- Do not cut the fiber cable. If the fiber cable is cut accidentally, please stop using the product and consult your OMRON representative.

Notes on Operation

Observe the following points to prevent the product from becoming inoperative or malfunctioning, or to avoid adverse effects on its performance or device.

1. Power Supply, Connection and Wiring

- Never bundle the marker head control cable and the marker head power supply cable together with 200/100 [VAC] power wires or the power wire or control wire of the AC motor, AC servo motor, or electromagnetic valve, etc. that is being used on your system. Bundling them together will cause noise to enter the galvanometer control cable and the I/O cable for the external control device, which may result in a laser marker malfunction.
- If there is a surge in the power supply line, connect a surge absorber depending on the operating environment.
- Do not step on the cables.

2. Operating Environment

- To prevent power supply noise or radiant noise from occurring, be sure to implement measures against noise, such as a spark killer, at the locations where a surge can occur, such as the point of contact with the motor used for surrounding devices.
- Refrain from using a cellular phone as it may cause the laser marker to malfunction.

3. Work materials

Follow the instructions below when using this product with gold, silver, copper, or other highly reflective materials. Reflected beams may damage the marker head.

(1) For a work positioned horizontally to the marker, do not mark within $\phi 6$ mm of the center of the marking area.

(2) If the marking surface of the work is slanted or curved, ensure that the specular reflection beam is not reflected back into the marker head.

Please consult with our sales center when using this product within these conditions.

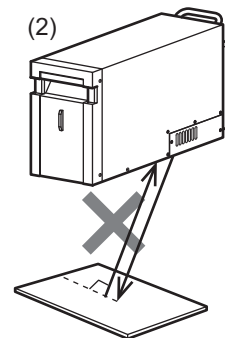
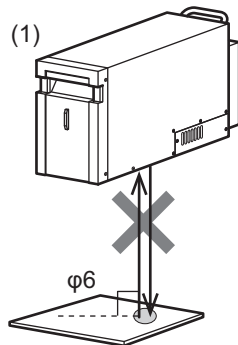

4. Maintenance Inspection

- If the cover glass of the marker head laser irradiation port gets dirty, the laser output may drop or a failure may occur. Do not use this product while the cover glass is dirty.
- Do not use thinner, benzene, acetone or kerosene items to clean the marker head or the controller. Carefully remove dirt or dust on the cover glass without scratching it by moistening with cleaning agent a piece of cleaning paper specifically for use on an optical device.

5. Storage

Do not store the product in an environment described below.

- Storage temperature: -10 to 60 °C (Non condensation or freezing)
- Storage humidity: 35 to 85% RH (No condensation)
- Outdoor or area subject to direct sunlight
- Area where corrosive gas, flammable gas, oil or mist may be present
- Area that is constantly vibrating or subject to startling vibration
- Very dusty area

The aforementioned points do not guarantee any unforeseen situations that may arise from storing of the product.

6. Packing and Transporting

This product is a precision machine. Please carefully observe the following points to avoid damaging the product if you are packing and transporting the product. When transporting the product, use the packing materials that were used at the factory setting by OMRON.

- Do not stack it on top of anything.
- Do not apply strong pressure on the cables.
- Pack and transport the product in the same direction as it was installed.
- Protect the control panel, display panel, connector and other parts from damage.
- Prevent condensation.
- Prevent the product from rolling over or falling, or do not apply strong impact.
- Refer to the previous item, "Storage," for details of storing the product that is packed and is in transit.

The aforementioned items do not guarantee any unforeseen situations that may arise from packing or transporting of the product.

Applicable Standards

1. EU directives and UK legislations

We have confirmed that this product satisfies the requirements of EU directives and UK legislations on the basis of the following requirements.

Keep the following requirements in mind when you use this product in EU countries and UK.

EMC Standards

This equipment is not intended for use in residential environments and may not provide adequate protection to radio reception in such environments.

- Make sure to attach the ferrite core to the position specified in "Fiber Laser Marker MX-Z2000H-V1 series Setup Manual" (Z415).
- When RS-232C or RS-422A serial port is used, use a shielded twisted pair cable (AWG24) equivalent to UL2464U-TKVVBS (Tachii Electric Wire). MX-9160-1M, 3M, and 5M (option) cables are available for RS-232C to connect this product with the PLC.
- Use a shielded cable 5m or less for connecting to the Ethernet port.
- Use a shielded cable (AWG12 to 26) for connecting to the removable terminals (for input and output) and I/O connector.
- We do not guarantee that this product works with any monitor, mouse, or keyboard. Check the compatibility before selecting a device.



Precautions for Safe Use

These requirements do not guarantee that all machinery and equipment with this product incorporated satisfy the requirements of EMC. Manufacturers of the machinery and equipment are responsible for verifying the compatibility of the product with all the machinery and equipment.

Safety Standards

■ Low Voltage

EN61010-1 "Safety requirements for electrical equipment for measurement, control, and laboratory use - Part 1: General requirements"

EN60825-1 "Safety of laser products - Part 1: Equipment classification and requirements"

- Install in a place with an altitude of 3000 m or less.
- Install indoors.
- The laser marker is a class 4 product. It is your responsibility to build your own safety system when using the product.



" For Safe Use of Laser Products (page 1-13)"

■ Machinery

When incorporating this product into a device that complies with IEC60204-1 "Safety of machinery - Electrical equipment of machines - Part 1: General requirements", the exterior of the product may need to be changed. Please purchase the "Masking set" (MX-9190) that helps you easily change the exterior of your laser marker.

2.UL standards

We have confirmed and received certification that this product satisfies the requirements of the UL standard on the basis of UL 61010-1.

3.Regulation of perchlorate in California, United States

This product uses parts that contain perchlorate. When you bring this product or a device with this product incorporated into California in the United States, the following statement must be indicated on the individual packing box and shipping box or on documents such as manuals or MSDS included in the package.

Perchlorate Material - special handling may apply, see

<http://www.dtsc.ca.gov/hazardouswaste/perchlorate/>

4.Korean Radio Waves Act

This equipment is an industrial (Class A) electromagnetic wave generator. Dealers and users should keep this in mind and use this equipment outside the household.

사 용 자 안 내 문

이 기기는 업무용 환경에서 사용할 목적으로 적합성평가를 받은 기기로서 가정용 환경에서 사용하는 경우 전파간섭의 우려가 있습니다

5.List of Applicable Standards

This product complies with the following standards.

Note that this product is not certified by safety standards in countries and regions not listed.

When exporting the laser marker overseas alone or incorporated into a machine or device, always check the laws and standards in the country or region the product is exported to.

Applicable Standards	Details
JIS (Japanese Industrial Standards)	Compliant with JIS C 6802 "Safety Standards for Laser Products"
Radio Act (Japan)	Not applicable (Corresponds to facilities not requiring permission)
FDA (U.S. Food and Drug Administration) regulations	21 CFR1040.10 except for deviations pursuant to Laser Notice No. 50 "PART 1040 PERFORMANCE STANDARDS FOR LIGHT-EMITTING PRODUCTS" Evaluated under IEC60825-1
FCC	47 CFR Part15 Subpart B Class A Digital Device
ICES	ICES-001 Class A ISM equipment
Korean Radio Waves Act	Korean Radio Waves Act Electromagnetic interference (EMI) • KN11 • KN61000-6-4 Electromagnetic susceptibility (EMS) • KN61000-6-2
EU directives / UK legislations	2014/30/EU "EMC directive" and Electromagnetic Compatibility Regulations 2016 Electromagnetic interference (EMI) • EN61000-3-2 Class A "Harmonic emission" • EN61000-3-3 "Voltage fluctuations and flicker" • EN61000-6-4 "Emission standard for industrial environments" Electromagnetic susceptibility (EMS) • EN61000-6-2 "Immunity standard for industrial environments" 2014/35/EU "Low Voltage Directive" and Electrical Equipment (Safety) Regulations 2016 • EN61010-1 "Safety requirements for electrical equipment for measurement, control, and laboratory use - Part 1: General requirements" • EN60825-1 "Safety of laser products - Part 1: Equipment classification and requirements"
UL, CSA Standards	UL61010-1, CAN/CSA C22.2 No.61010-1
GB Standards	GB7247.1
RCM	EN61000-6-4

For Safe Use of Laser Products

Although JIS C6802-compliant safety measures are incorporated in this product, the safety measures can be effective only when the user of the product understands the functions of these measures. Accordingly, please keep in mind that JIS C6802-compliant products are products in which the safety measures specified by JIS C6802 are incorporated, and that the products, on their own, are not necessarily safe.

This product is categorized as class 4 based on the JIS C6802 classification. The product incorporates the function of the safety measures based on JIS C6802 for the protective casing of the laser oscillator part, cover interlock, remote interlock (external interlock), key control, laser emission display, opening label, classification label, warning label, radiant output information label, and optical path cut-off (internal shutter).

Users of the product must use these functions to apply the safety measures.

Safety Measures for Class 4 Products

(1) Assignment of the laser safety manager

A laser safety manager is "a person who has the sufficient knowledge required to evaluate the danger of laser and to ensure safety and who is responsible for the laser management," and is selected based on the level of knowledge and experience in handling laser devices and prevention of interference due to laser emission. Such a person must conduct tasks equivalent to those of a laser device manager based on the "Measures to prevent interference caused by laser beams" issued by the Ministry of Health, Labour and Welfare (March 25, 2005).

(2) Setting and management of the laser controlled area

Separate the area from other areas and place a sign to clearly indicate that the area is a laser controlled area. Ensure that only authorized personnel are allowed to enter the area.

Do not allow any hazardous materials such as explosives and flammables to be brought into the controlled area.

(3) Warning displays and signs

- Post signs of danger and hazard of a laser beam and its handling precautions in locations where the signs are easily seen.
- Post the name of the laser safety manager.

(4) Use of remote interlock

When using this product, construct an interlock system and surround the laser emission area with protection in order to prevent radiation exposure due to reflections from the object to be marked or the surrounding area. Also, install the controller in a location not being exposed to laser beams.



"Fiber Laser Marker MX-Z2000H-V1 series Setup Manual" (Z415)

(5) Management of the keys to operate the laser devices

While a laser device is not in use, be sure to remove the system key and pass it to the safety manager for safekeeping in order to keep the laser from being operated by unauthorized personnel or without permission.

(6) Setting and verification of the beam path position

Setting the beam path position lower than the eye level of a seated person or higher than the eye level of a standing person can prevent laser beams from getting in the eye accidentally.

(7) Handling of the end terminal

Take into consideration when no work exists and terminate the laser radiation range with a reflecting diffuser or absorber with appropriate reflectance and heat resistance.

(8) Prevention of specular reflection

Do not use a specular reflector at the terminal.

(9) Cut-off and attenuation of beam

Be sure to install a protective enclosure around the laser radiation range and scattered beams in order to prevent radiation exposure due to unexpected reflection from the printed object and surrounding objects.

Scattered beams may exceed class 1 level. Take measures to prevent laser exceeding class 1 level from leaking through the gaps in the protective casing joints.

(10) Inspection and maintenance of protective gear (safety glasses, protective wear, flame-resistant materials)

- Wearing laser safety glasses for eye protection in the laser controlled area must be mandatory.
 - Use laser safety glasses that covers wavelength range of 1062 nm.
 - Do not look at a direct or reflected laser beam even with safety glasses on.
 - Safety glasses are for protecting eyes from scattered beams, not for protecting eyes from direct or reflected beams.
- Laser beam irradiation to the skin may cause burns and irradiation to clothing may cause it to burn.
 - Wear flame-retardant clothing with as little skin exposure as possible.

(11) Safety training/practice

(12) Occupational health (Medical examinations (anterior part of the eye and ocular fundus))

(13) Other measures to prevent any interference due to laser radiation (system protective casing, safety inspections, etc.)

Caution -- use of controls or adjustments or performance of procedures other than those specified herein may result in hazardous radiation exposure.

Risk Level and Safety Measure

Summary of safety measures requirements for users (JIS C6802)

Requirements	Classification						
	Class 1	Class 1M	Class 2	Class 2M	Class 3R	Class 3B	Class 4
Laser safety manager	Not required, but recommended to have one in place for an application that involves direct observation of the laser beam.				Not required for visible radiation. Required for non-visible radiation.	Required	
Remote interlock	Not required					Connect to the room or the door circuit.	
Control with a key	Not required					Unlock when not in use.	
Beam attenuator	Not required					Avoid inadvertent emission when in use.	
Emission indicator	Not required				Indicates that laser is being emitted in non-visible wavelengths.	Indicates that laser is being emitted.	
Warning sign	Not required					Follow the safety measure described on the warning sign.	
Beam path	Not required	Same as class 3B	Not required	Same as class 3B	Terminate the beam at an end of an effective length.		
Specular reflection	No required item	Same as class 3B	No required item	Same as class 3R	Avoid unintended reflection.		
Eye protection	No required item					Required when the technical and administrative procedures cannot be executed, and when the laser level exceeds the MPE ^(*1) .	
Protective clothes	No required item					Required in some cases.	Requires specific instructions.
Practice	No required item	Same as class 3R	No required item	Same as class 3B	Required for all operators and maintenance personnel.		

*1: MPE (Maximum Permissible Exposure)
Maximum value of the level of laser irradiation to which a person may be exposed without hazardous effects in a normal environment.

Note: The table lists the required elements for your convenience.

Laser Information

■ Class 4 laser (processing laser)

Class 4 lasers are defined to "have a possibility of causing acute vision disturbances and skin damage with direct and scattered beams and causing a fire".

Item	Specification			Remarks
	MX-Z2000H-V1	MX-Z2050H-V1	MX-Z2055H-V1	
Wavelength	1062 nm			Invisible laser
Laser medium	Yb: Fiber			-
Maximum output ^{*1}	40 W			-
Average output	20 W (fiber laser oscillator output)			-
Laser oscillation type	Pulse oscillation			-
Pulse cycle	10 kHz to 1000 kHz			-
Pulse width	1 to 500 ns			-
Class	4			-
NOHD ^{*2}	 " ■ Radiation range (page 15)"			Nominal Ocular Hazard Distance
MPE ^{*3}	MPE for the cornea: 50 W/m ²			Maximum Permissible Exposure
NOHA	Indicates an area where the laser beam radiation intensity or radiation exposure exceeds the maximum permissible exposure. The maximum hazard distance and range are the same as a sphere that has the radius of NOHD. It changes according to the workpiece reflectance and surface conditions. Calculate the value taking the actual usage conditions into consideration.			Nominal Ocular Hazard Area

*1: Maximum output refers to the maximum power of the laser beam that the device may output under all operating conditions including during a single point of failure. (The maximum output may exceed the highest output during normal operation.)

*2: Indicates the distance from the source at which the beam radiation intensity or radiation exposure becomes equal to the maximum permissible exposure for the cornea.

*3: The value is calculated with the exposure time set to 10 seconds.

■ Radiation range

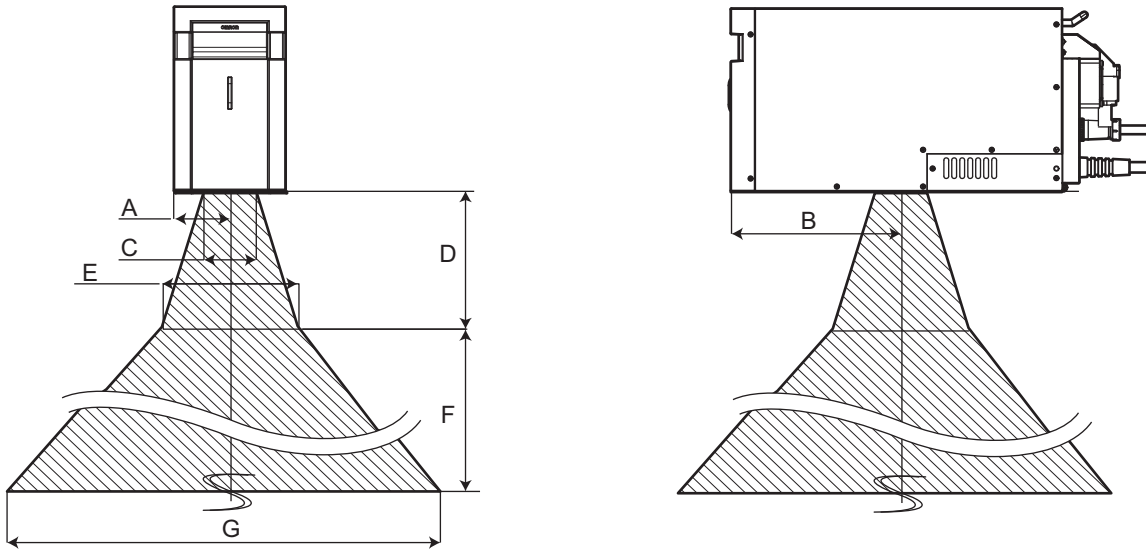

Unit: mm

Position	Specification		
	MX-Z2000H-V1	MX-Z2050H-V1	MX-Z2055H-V1
A: Laser irradiation port center position	70		
B: Laser irradiation port center position	210		
C: Laser irradiation port diameter	65		
D: Working distance	170	220	
E: Laser radiation range in focusing surface	φ342	φ423	
F: NOHD	22 m	29 m	57 m
G: Laser radiation range in NOHD	φ17 m	φ31 m	φ60 m

■ Class 2 laser (guide laser, focus pointer)

Class 2 lasers are defined as "laser products that are safe when exposure is momentary and the eye is protected by defensive reactions such as blinking, but are hazardous when the beam is stared into deliberately".

Item	Specification			Remarks
	MX-Z2000H-V1	MX-Z2050H-V1	MX-Z2055H-V1	
Wavelength	655 nm			Visible laser
Laser medium	Semiconductor laser			-
Maximum output	1 mW			-
Laser oscillation type	CW (continuous wave)			-
Class	2			-

■ Safety Functions of Laser Marker





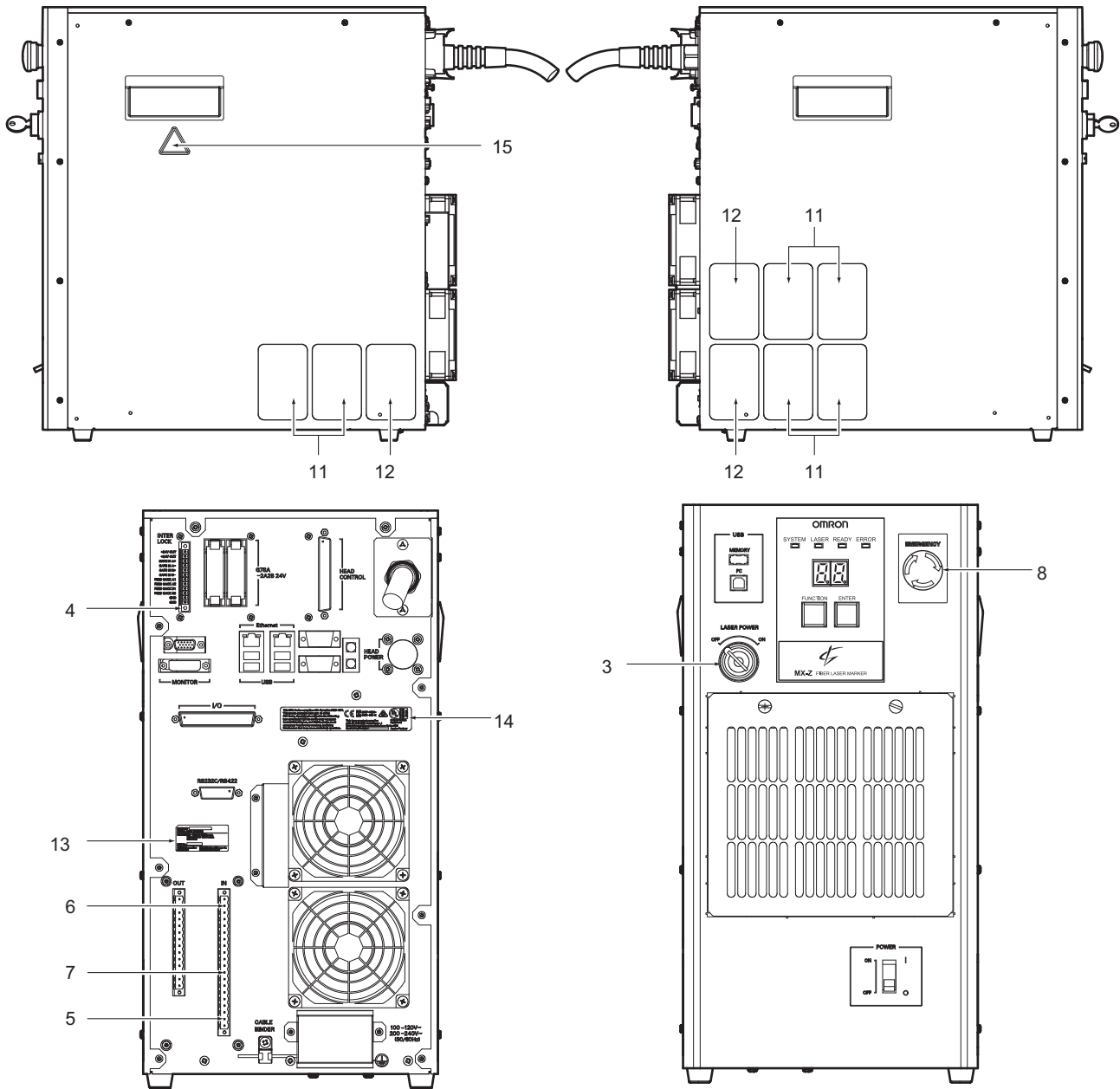

This product is equipped with the following safety functions.

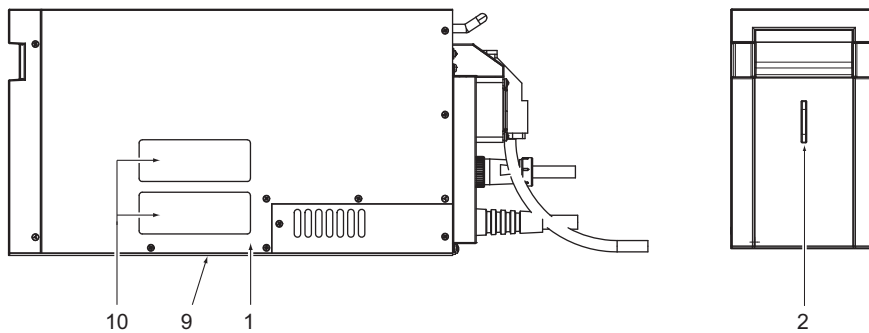
• Controller



• Marker head



No.	Name	Function															
1	Shutter	This shutter is located inside the head. Closing this shutter can block the emission of the laser beam.															
2	Laser warning indicator	<p>The laser warning indicator light indicates the following statuses.</p> <table border="1"> <thead> <tr> <th>Color</th> <th>Status</th> <th>Meaning</th> </tr> </thead> <tbody> <tr> <td>Unlit</td> <td>Laser power OFF</td> <td>The laser power is OFF.</td> </tr> <tr> <td>Green</td> <td>Laser power ON</td> <td>The laser power is ON and laser can be irradiated (laser standby mode).</td> </tr> <tr> <td>Red</td> <td>Processing laser irradiating</td> <td>Processing laser is being irradiated (marking is in progress).</td> </tr> <tr> <td>Green/red</td> <td>Guide laser irradiating</td> <td>Guide laser is being irradiated.</td> </tr> </tbody> </table>	Color	Status	Meaning	Unlit	Laser power OFF	The laser power is OFF.	Green	Laser power ON	The laser power is ON and laser can be irradiated (laser standby mode).	Red	Processing laser irradiating	Processing laser is being irradiated (marking is in progress).	Green/red	Guide laser irradiating	Guide laser is being irradiated.
Color	Status	Meaning															
Unlit	Laser power OFF	The laser power is OFF.															
Green	Laser power ON	The laser power is ON and laser can be irradiated (laser standby mode).															
Red	Processing laser irradiating	Processing laser is being irradiated (marking is in progress).															
Green/red	Guide laser irradiating	Guide laser is being irradiated.															
3	Key switch	The laser power ON/OFF can be controlled with the key switch. While a laser system is not in use, the safety manager must keep the system key in order to keep the laser from being operated without permission.															
4	Interlock connector	This connector is used to construct a mechanism that forcibly turns OFF the laser and stops the laser emission. Use this connector to utilize a device into which the laser marker is incorporated as the interlock system to comply with International Standards ISO13849-1 (JIS B 9705-1).															
5	I/O emergency stop input	Set the [EMERGENCY A] (emergency stop input A) or [EMERGENCY B] (emergency stop input B) terminal to open (OPEN) to forcibly close the shutter inside the marker head and stop the laser emission.															
6	Marking stop input	Input a signal to [STOP] to stop the processing laser emission and operate in the guide laser mode.															
7	Shutter control input	Open the [SHUTTER A] (shutter control input A) or [SHUTTER B] (shutter control input B) terminal to close the shutter.															
8	Emergency stop switch	If you want to immediately stop the marking, press this switch to turn OFF the laser power.															
9	Laser beam exit	This is the laser irradiation port.															
10	JIS/EN laser warning label	 JIS/EN laser warning label (Japanese/English) (page 18)															
	EN laser warning label (German/French)	 EN laser warning label (German/French) (page 18)															
11	Electric shock warning label	 Electric shock warning label (page 19)															
12	Igniting or explosion warning label	 Igniting or explosion warning label (page 19)															
13	Name plate	 Name plate (page 20)															
14	Standard label	 Standard label (page 20)															
15	Caution label for fall hazards	 Caution label for fall hazards (page 20)															

Warning Label Display

● Marker Head

The JIS (Japanese), EN (English), and EN (German/French) laser warning labels are affixed on the marker head. GB (simplified) and IEC (traditional) warning labels are also included. Affix the appropriate label according to the regulations and standards in the country/region the product is used.

• JIS/EN laser warning label (Japanese/English)

危険—可視及び不可視レーザー放射 ビームや散乱光の目又は皮膚への被ばくを避けること Yb : Fiber レーザ 最大出力 : 40W 最大ピークパワー : 30kW パルス幅 : 1-500ns 波長 : 1062nm クラス4 レーザ製品 JIS C 6802: 2014	DANGER—VISIBLE AND INVISIBLE LASER RADIATION AVOID EYE OR SKIN EXPOSURE TO DIRECT OR SCATTERED RADIATION Yb : Fiber laser Maximum output : 40W Maximum peak power : 30kW Pulse duration : 1-500ns Wavelength : 1062nm CLASS 4 LASER PRODUCT EN 60825-1 : 2014
	被ばくを回避のこと この開口から可視 (クラス2) 及び不可視 (クラス4) レーザ放射が出る AVOID EXPOSURE CLASS 2 VISIBLE AND CLASS 4 INVISIBLE LASER RADIATION IS EMITTED FROM THIS APERTURE

• EN laser warning label (German/French)

GEFAHR—SICHTBARE UND UNSICHTBARE LASERSTRAHLUNG BESTRAHLUNG VON AUGE ODER HAUT DURCH DIREKTE ODER STREUSTRABUNG VERMEIDEN Yb : Faserlaser Maximale ausgangsleistung : 40W Maximale spitzenleistung : 30kW Impulsdauer : 1-500ns Wellenlänge : 1062nm LASER KLASSE 4 EN 60825-1 : 2014	DANGER—RAYONNEMENT LASER VISIBLE ET INVISIBLE ÉVITER EXPOSITION DANGEREUSE DE L'OEIL OU DE LA PEAU AU RAYONNEMENT DIRECT OU DIFFUS Yb : Laser à fibre Puissance de sortie maximale : 40W Puissance crête maximale : 30kW Durée d'impulsion : 1-500ns Longueur d'onde : 1062nm LASER DE CLASSE 4 EN 60825-1: 2014
	BESTRAHLUNG VERMEIDEN AUSTRITT VON SICHTBARER UND UNSICHTBARER LASERSTRAHLUNG ÉVITER LE RAYONNEMENT UN RAYONNEMENT LASER VISIBLE ET INVISIBLE EST ÉMIS PAR CETTE OUVERTURE

• GB/IEC laser warning labels (Simplified/Traditional Chinese)

可见及不可见激光辐射 避免眼睛或皮肤受到直射或散射照射 Yb : Fiber 激光 最大输出 : 40W 最大峰值功率 : 30kW 脉冲幅 : 1-500ns 波长 : 1062nm 4 类激光产品 GB 7247.1-2012	可见及不可见雷射辐射 避免眼睛或皮膚暴露於直射或散射輻射 Yb : Fiber 雷射 最大輸出 : 40W 最大峰值功率 : 30kW 脈衝幅 : 1-500ns 波長 : 1062nm 第 4 類雷射產品 IEC 60825-1:2014
	可见及不可见激光窗口 避免受到从本窗口射出的激光辐射的照射 可见及不可见雷射孔徑 避免受到此口徑射出之雷射辐射的照射

● **Controller**

Japanese, English, and French version of electric shock warning label (grounding), electric shock warning label (disassembly), igniting or explosion warning label (Lithium batteries) are affixed on the controller.

• **Electric shock warning label (grounding)**

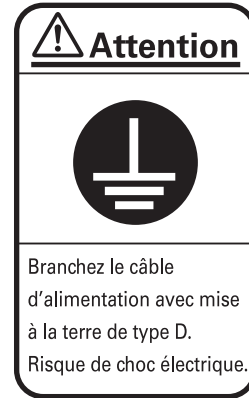
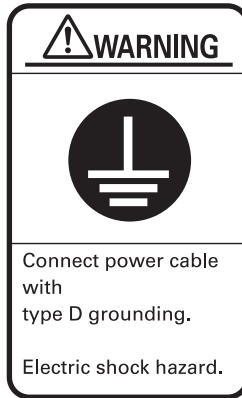

• **Electric shock warning label (disassembly)**

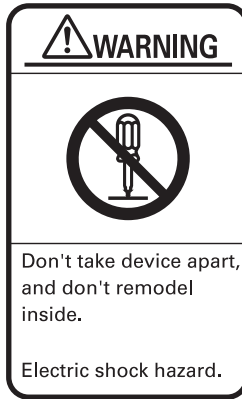

• **Igniting or explosion warning label (Lithium batteries)**



• Name plate

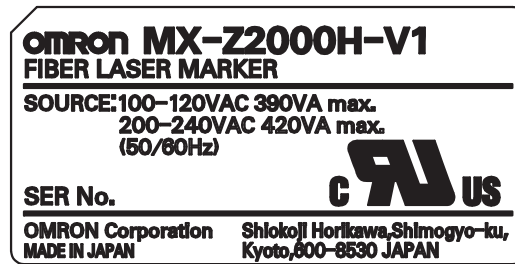

• Standard label



Dispose of this product and parts that require replacement in accordance with applicable regulations.

This ISM device complies with Canadian ICES-001. This device complies with part 15 of the FCC Rules. Operation is subject to the following two conditions: (1) This device may not cause harmful interference, and (2) this device must accept any interference received, including interference that may cause undesired operation.



R-R-OMR-
MX-Z-HV1



This laser product complies with 21 CFR FDA Subchapter J (except for deviations pursuant to Laser Notice #50)

MANUFACTURED: Kusatsu Factory



Additional Information

The manufacturing date on the standard label differs depending on the actual manufacture date.

• Caution label for fall hazards

If you press hard on the side of the controller or apply an impact, it may fall over. Please install after safety measures.



• Caution label for battery replacement

The button battery is mounted inside the controller. Please use Panasonic CR2032 button battery to replace. Using different batteries may lead to smoke and fire accidents.



Caution label for battery replacement

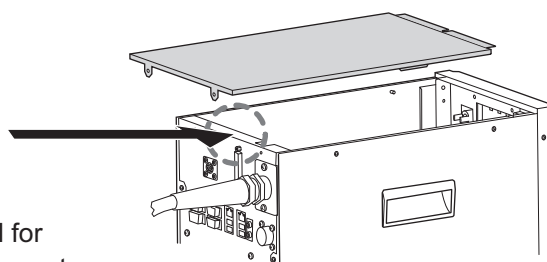

The caution label for battery replacement is attached to the top of the back plate and can only be seen when the lid opened.

Software License Agreement

This is a binding agreement between OMRON Corporation ("OMRON") and you (the "User") on the terms and conditions of the license of the Software.

- (1) In this agreement, "Software" means the computer program and related technical documentation contained in this package. The copyright of the Software remains the sole property of OMRON or the third party who has licensed the Software to OMRON, and shall not be assigned to the User under this Agreement.
- (2) OMRON grants the User a non-exclusive license to use the Software only on a computer owned by the User.
- (3) The User shall not sub-license, assign, nor lease the Software to any third party without prior written consent of OMRON.
- (4) The user may copy the Software for back-up purpose only. The User may not de-compile, disassemble, reverse engineer, nor otherwise attempt to discern the source code of the Software.
- (5) The User shall treat any information contained in the Software as confidential and shall not disclose it to any third party. This obligation shall survive the termination of this Agreement.
- (6) OMRON warrants to the User that the Software will perform substantially in accordance with the user manual provided. If the User discovers defect of the Software (substantial non-conformity with the manual), and return it to OMRON within 1 year of purchase, OMRON will replace the Software without charge.
- (7) The above replacement shall constitute the User's sole and exclusive remedies against OMRON, and in no event, OMRON will be liable for any direct or indirect consequential damages arising out of the use of the Software.
- (8) In any event, OMRON's entire liability to the damage made by User for any cause shall not exceed the amount actually paid by the User to purchase the Software.
- (9) If the User breaches this Agreement, OMRON may terminate this Agreement upon notice to the User. In such an event, the User shall return the Software and all copies thereof to OMRON.

End

How to Use This Manual

Page Structure

Pages of this manual are structured with components described below.

Section title

Indicates the section title of the current page.

Procedure number

Indicates the operation procedure number.

Remarks

Indicates additional explanations or points that require special attention. (Refer to the next page.)

5 Useful Functions

5.1 View Setting Function

This section explains the sheet view setting functions to create and edit marking data efficiently.

Zoom In/Zoom Out

You can zoom in/out (x 0.5 to x 512) on the sheet.

- 1 Click [View] on the menu bar and, then select [Zoom], and select one of the following from the sub-menu.

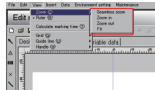

Item	Description
Seamless zoom	Zooms in on the area specified by a dragging of the mouse.
Zoom in	Zooms in at x 2 of the current display magnification ratio.
Zoom out	Zooms out at x 1/2 of the current display magnification ratio.
Fit	Sets to the magnification ratio of x 1.0 (100%) regardless of the current display magnification ratio.

Additional Information

The view area can be zoomed in/out with the buttons below the sheet to change the view setting and blocks.

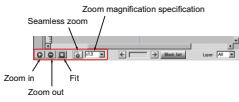

5 - 2 Fiber Laser Marker MX-Z2000H-V1 series User's Manual (Z416)

Item title

Indicates the item title.

Chapter title

Indicates the chapter title of the current page.

Heading

Indicates the chapter number and section title included in the chapter.

5 Useful Functions

Ruler View

Rulers are displayed on the sheet.

- 1 Click [View] on the menu bar, and then select [Ruler].

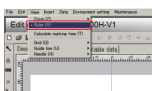

A check mark is placed on the left side of the menu display, and the rulers are displayed at the top and left sides of the sheet.

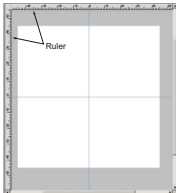

When you select [View] - [Ruler] again, the rulers will disappear.

Additional Information

The rulers are set to "View" in the default setting.

Grid View

Grids are displayed on the sheet.

- 1 Click [View] on the menu bar, and then select [Grid] and [View].

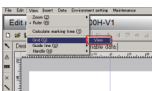

5 - 3 Fiber Laser Marker MX-Z2000H-V1 series User's Manual (Z416)

Symbol

In this manual, additional notes and information that require particular attention are indicated with the following symbols.



Precautions for Safe Use

Indicates a caution and a limitation that need to be executed or avoided when using the product.



Precautions for Correct Use

Indicates a caution for an operation that is error-prone.



Additional Information

Indicates useful information and references.



Reference

Indicates the name of a manual, section and page number to be referenced.

Table Of Contents

EMC Standards.....	1-11
Safety Standards.....	1-11
Safety Measures for Class 4 Products.....	1-13
Risk Level and Safety Measure	1-14
Laser Information	1-14
Warning Label Display	1-18
Page Structure	1-22
Symbol	1-23

Chapter1 Preparation 1-1

1.1 Overview of Software.....	1-2
Marker Software and Offline Editing Software	1-2
Installing and Starting the Offline Editing Software	1-3
Transferring Data	1-6
Creating and Editing Data Using Offline Editing Software	1-13
1.2 Basic Knowledge of Marking	1-14
Edit Mode and Operation Mode	1-14
Explanation of Terms.....	1-17
DFL (Direct Finder Link).....	1-26
Block Types.....	1-30
Part File.....	1-34
Reference Folder Settings	1-35

Chapter2 Creating Marking Data 2-1

2.1 Flow of Creating Marking Data	2-2
2.2 Coordinate	2-3
Coordinate.....	2-3
Handling of Coordinate in Marker Software	2-5
Position Correction.....	2-5
Marking Direction	2-5
Marking Area	2-6
2.3 Screen Configuration.....	2-7
2.4 Block Operation	2-9
Handle.....	2-9
Operation with Mouse	2-9
Switching the Selected Block.....	2-10
Grouping the Blocks.....	2-10
2.5 Preparation for Creating Marking Data	2-12
Creating New Marking Data	2-12
Editing the Marking Data.....	2-12
2.6 Block Setting	2-14
[Text] Block.....	2-14
[ID code] Block	2-41
[Fixed point] Block.....	2-66
[Line] Block.....	2-70
[Rectangle] Block	2-75

[Circle] Block	2-82
[Arc] Block	2-90
[Image] Block.....	2-96
[Graphic] block	2-101
Loading the Part File	2-106
2.7 Common Setting.....	2-108
[Marking] tab.....	2-109
[Position] tab.....	2-111
[Laser/Scan] tab	2-115
[Pallet] tab	2-118
[DFL] tab.....	2-118
2.8 Pallet Setting.....	2-125
2.9 Saving the Marking Data.....	2-134
Save	2-134
Save As	2-134
Chapter3 Performing Test Marking	3-1
<hr/>	
3.1 Performing Test Marking	3-2
Chapter4 Marking	4-1
<hr/>	
4.1 Flow of Marking Tasks	4-2
4.2 Screen Configuration.....	4-3
4.3 Loading the Marking Data	4-5
4.4 Starting Marking	4-7
4.5 Monitoring Marking Status	4-9
Monitoring Current Marking Status.....	4-9
Monitoring Counter, Time Hold and Variable Data	4-10
Monitoring Marking Operation History/Error History.....	4-11
Communication Monitor	4-12
I/O Monitor.....	4-13
4.6 Monitoring Error Status	4-14
Monitoring Error Status	4-14
Description of Error Status Display	4-14
Cancelling the Error.....	4-14
Chapter5 Useful Functions	5-1
<hr/>	
5.1 View Setting Function	5-2
Zoon In/Zoom Out.....	5-2
Ruler View	5-3
Grid View	5-3
Guide Line View	5-4
Handle Snap Setting	5-6
Non-marking Target Setting/Lock Setting	5-7
Layer Creation	5-9
Switching Layer	5-11
5.2 Part File Registration Function	5-12

5.3	Block List Display Function	5-13
	Block List.....	5-13
5.4	Variable Data Table Setting Function	5-17
	Creating Variable Data Table.....	5-19
	Setting Blocks Using the Variable Data Table	5-20
	Changing Index Numbers	5-23
	Example of Creating Variable Data Table.....	5-26
5.5	Date/Time Variable Data Table Setting Function	5-30
	Creating Date/Time Variable Data Table	5-32
	Setting Blocks Using the Date/Time Variable Data Table.....	5-35
	Example of Creating Date/Time Variable Data Table	5-38
5.6	Counter Setting Function	5-45
5.7	Time Hold Calculation Function	5-48
5.8	Marking Time Calculation Function.....	5-49
5.9	Other Functions	5-50
	Starting the Font Logo Editor (Offline Editing Software Only).....	5-50
	View Manual (Offline Editing Software Only)	5-50
	Offline Editing Software View Version (Offline Editing Software Only).....	5-51
 Chapter6 Environment Setting		 6-1
6.1	Marker Operation Setting	6-2
	I/O Setting	6-2
	Serial Communication Setting.....	6-4
	Startup Setting	6-6
	Laser power check settings.....	6-6
6.2	Edit Setting	6-8
6.3	Date/Time Setting	6-10
6.4	Operation Limits Setting	6-11
6.5	Reset to default value	6-14
6.6	Language Setting	6-15
6.7	Ethernet Setting	6-17
6.8	Reference Folder Settings.....	6-19
6.9	Coordinate Correct Setting	6-20
6.10	EE Mode Setting.....	6-24
 Chapter7 Maintenance and Adjustment		 7-1
7.1	Position Correction	7-2
7.2	Power Monitor	7-4
7.3	Warm Up.....	7-7
7.4	History/Trace Output.....	7-8
7.5	Traceability Log Setting.....	7-9

7.6	Life Counter	7-11
7.7	Get Z-axis Home	7-12
7.8	I/O Test	7-13
7.9	Serial Communication Test	7-14
7.10	Backup/Restore	7-15
	Backing Up the Marking Data.....	7-15
	Restoring the Marking Data.....	7-16
7.11	Installing TrueType Fonts	7-17
7.12	Version Management	7-19

Chapter8 Operation and Control by Serial Communication **8-1**

8.1	Serial Communications	8-2
8.2	Interface Specifications and Connection Examples	8-3
	Serial Communication Specifications	8-3
	Connector Specifications.....	8-4
	Example of Connection with External Device.....	8-5
	Control Example of Serial Communications	8-6
8.3	Data Format	8-9
	Message Format	8-9
	Command/Response Data	8-10
8.4	Communication Procedure	8-12
	Basic Communication Procedure	8-12
8.5	Types of Communication Commands Used	8-13
8.6	Details of Communication Commands	8-16
	Cancel Error - ERRRESET (ERRT)	8-16
	Acquire Error - ERRGET (ERGT).....	8-16
	Save Edited Data - MARKINGDATASAVE (MKSX)	8-17
	Start Edit - EDITRESERVEON (RVON).....	8-17
	End Edit - EDITRESERVEOFF (RVOF).....	8-17
	Marking Parameter Setting - EDITMARKINGSET (MHST).....	8-18
	Marking Parameter Acquisition - EDITMARKINGGET (MHGT)	8-20
	Pallet Parameter Setting - EDITPACKAGESET (PKST)	8-22
	Pallet Parameter Acquisition - EDITPACKAGEGET (PKGT)	8-24
	Cell Parameter Setting - EDITPACKAGECELLSET (PCST).....	8-25
	Cell Parameter Acquisition - EDITPACKAGECELLGET (PCGT).....	8-26
	Block Parameter Setting - EDITBLOCKSET (BLST).....	8-27
	Block Parameter Acquisition - EDITBLOCKGET (BLGT).....	8-28
	Layer Parameter Setting - EDITLAYERPARAMSET (LPST).....	8-29
	Layer Parameter Acquisition - EDITLAYERPARAMGET (LPGT).....	8-31
	Specified Block String Setting - EDITBLOCKSTRSET (BSST).....	8-32
	Specified Block String Acquisition - EDITBLOCKSTRGET (BSGT).....	8-33
	Batch Cell Marking Enabling Setting - EDITENABLECELLSET (ECST).....	8-33
	Batch Cell Marking Disabling Setting - EDITDISABLECELLSET (DCST).....	8-33
	Setting of a Block of Multiple Stings - EDITMULTIBLOCKSET (MBST).....	8-34
	Marking Content Acquisition - MARKINGDATAGET (MDGT)	8-34
	Block Processing Parameter Setting - EDITBLOCKPARAMSET (BPST)	8-35
	Block Processing Parameter Acquisition - EDITBLOCKPARAMGET (BPGT)	8-36
	Marking Data List - MARKINGLIST (MKLT)	8-36
	Marking Data Name Setting - MARKINGNAMESET (MNST)	8-37

Marking Data Name Acquisition - MARKINGNAMEGET (MNGT)	8-37
Marking Data Information Acquisition - MARKINGINFOGET (MKIF).....	8-37
Block List - BLOCKLIST (BLLT)	8-38
Time Hold Setting - TIMEHOLDSET (THST)	8-38
Time Hold Status Acquisition - TIMEHOLDGET (THGT)	8-39
Counter Setting - COUNTERSET (TUST)	8-40
Counter Setting Acquisition - COUNTERGET (TUGT)	8-41
Count Up - COUNTERUP (TUUP).....	8-42
Counter Reset - COUNTERRESET (TURT)	8-42
Counter Status Acquisition - COUNTERSTATGET (TUTT)	8-43
Variable Data Table Index Specification - FLEXTABLESET (FXST)	8-44
Variable Data Table Index Acquisition - FLEXTABLEGET (FXGT)	8-44
Marking Data No. Specification- MARKINGIDSET (MKST)	8-44
Marking Data No. Acquisition - MARKINGIDGET (MKGT)	8-45
Position Correction Value Setting - OFFSETPARAMSET (OPST).....	8-45
Position Correction Value Acquisition - OFFSETPARAMGET (OPGT).....	8-46
Guide Laser Setting - GUIDEIDSET (GDST).....	8-46
Guide Laser Acquisition - GUIDEIDGET (GDGT)	8-47
Open the Shutter - SHUTTEROPEN (SHOP).....	8-47
Close the Shutter - SHUTTERCLOSE (SHCL).....	8-47
Device Status Acquisition - STATGET (STGT).....	8-48
Marking Start - MARKINGSTART (MKSr).....	8-48
Marking Stop - MARKINGSTOP (MKSP).....	8-48
Warm-up Start - WARMUPSTART (WUSR).....	8-49
Device Information Setting - MACHINEINFOSET (MIST).....	8-49
Device Information Acquisition - MACHINEINFOGET (MIGT)	8-50
Marking Status Acquisition - MARKINGSTATUSGET (MSGT)	8-50
Drive Information Acquisition - DRIVEINFOGET (DIGT)	8-51
File Data Transfer - FILEDATATRANSFER (FTTR)	8-52
Backup - MARKERDATABACKUP (MDBU).....	8-53
Restore - MARKERDATASTORE (MDRT).....	8-53
Power Monitor Measurement - MEASURELASERPOWER (MLPW)	8-53
Reference Folder Setting - REFERENCEFOLDERSET (RFST).....	8-54
Reference Folder Acquisition - REFERENCEFOLDERGET (RFGT).....	8-54
Marking Data Deletion - MARKINGDATADELETE (MKDT).....	8-54
Marker Start Setting Change - MARKERSTARTUPSET (MUST)	8-55
Marker Start Setting Acquisition - MARKERSTARTUPGET (MUGT).....	8-56
Laser Power Monitor Setting Change - LASERPOWERCHECKSET (LCST).....	8-57
Laser Power Monitor Setting Acquisition - LASERPOWERCHECKGET (LCGT)	8-58
Traceability Log Setting Parameter Change - TRACEABILITYPARAMSET (TBST).....	8-59
Traceability Log Setting Parameter Acquisition - TRACEABILITYPARAMGET (TBGT)	8-60
Traceability Log Setting Acquisition - TRACELOGGET (TLGT).....	8-61
Version Acquisition - VERSIONGET (VRGT)	8-62
Date/Time Setting - DATETIMESET (DTST).....	8-62
Date/Time Acquisition - DATETIMEGET (DTGT).....	8-62
Date and Time Setting with Set Parameters - DATEPARAMSET (DPST)	8-63
Call Back - CALLBACK (CLBK)	8-65
Power Check Execution - LASERPOWERCHECK (LPCK)	8-65

Chapter9 Operation and Control by Ethernet Communication 9-1

9.1 Ethernet Communications	9-2
9.2 Interface Specifications	9-3
Ethernet Communication Specifications	9-3
Connector Specifications	9-3
9.3 Data Format	9-4

Command Format	9-4
Response Format.....	9-4
Command/Response Data.....	9-5

Chapter10 Operation and Control by EtherNet/IP™ Communication 10-1

10.1 Introduction to EtherNet/IP™	10-2
Data Exchange with EtherNet/IP™	10-3
EtherNet/IP™ Communications.....	10-4
Communications Processing Flow	10-5
10.2 Communications Setup Procedures.....	10-6
Tag Data Link Setting Methods	10-6
10.3 Memory Allocation.....	10-10
10.4 Timing Chart.....	10-12
Command Execution.....	10-12
Process from marking start to using the marking start command	10-13
10.5 Command List.....	10-15
10.6 Command Details	10-18
Cancel error	10-18
Acquire error	10-19
Save edited data	10-21
Start edit.....	10-21
End edit.....	10-22
Marking parameter setting	10-23
Marking parameter acquisition	10-25
Pallet parameter setting	10-27
Pallet parameter acquisition.....	10-29
Cell parameter setting	10-30
Cell parameter acquisition.....	10-31
Block parameter setting	10-32
Block parameter acquisition	10-34
Layer parameter setting	10-36
Layer parameter acquisition.....	10-38
Specified block string setting.....	10-40
Specified block string acquisition	10-41
Batch cell marking enabling setting.....	10-43
Batch cell marking disabling setting	10-44
Marking content acquisition.....	10-46
Block processing parameter setting	10-48
Block processing parameter acquisition.....	10-49
Marking data name setting.....	10-50
Marking data name acquisition	10-52
Time hold setting.....	10-53
Time hold status acquisition	10-54
Counter setting.....	10-55
Counter setting acquisition.....	10-56
Count up.....	10-57
Counter reset	10-57
Counter status acquisition.....	10-58
Variable data table index specification	10-59
Variable data table index acquisition.....	10-60
Marking data No. specification	10-60
Marking data No. acquisition.....	10-61
Position correction value setting	10-62

Position correction value acquisition	10-63
Guide laser setting	10-64
Guide laser acquisition	10-65
Open the shutter	10-66
Close the shutter	10-66
Device status acquisition.....	10-67
Marking start	10-68
Marking stop.....	10-68
Warm-up start.....	10-69
Device information setting.....	10-69
Device information acquisition	10-70
Marking status acquisition.....	10-71
Backup	10-72
Restore.....	10-72
Power monitor measurement.....	10-73
Laser power monitor setting change	10-74
Laser power monitor setting acquisition.....	10-75
Traceability log setting parameter change	10-76
Traceability log setting parameter acquisition	10-77
Date/time setting	10-78
Date/time acquisition.....	10-79
Power check execution	10-80
10.7 Command Settings	10-81
2's Complement	10-81
Parameter Notation Examples for Command Control.....	10-81
Command Setting Example	10-82

Chapter11 How to Use Font Logo Editor 11-1

11.1 Functions of Font Logo Editor.....	11-2
11.2 Starting and Ending Font Logo Editor	11-6
Starting the Font Logo Editor	11-6
Ending the Font Logo Editor	11-7
11.3 Screen Configuration and Function of Each Part	11-8
Overall Configuration	11-8
Function of Menu Bar.....	11-12
11.4 Creating Font.....	11-29
Example 1 - Drawing and Saving New Text -	11-29
Example 2 - Drawing a Text Based on a Model/Saving to an Existing Font File -	11-35
11.5 Creating Fill Pattern	11-43
Example - Create a Spiral-shaped Fill Pattern -	11-43
11.6 Creating Logo.....	11-45
Example	11-45
11.7 Installing Data to Laser Marker	11-55

ChapterA Appendix A-1

A.1 Specifications of Menu Bar and Toolbar.....	A-2
Manu bar	A-2
Toolbar	A-7
A.2 Menu Item List.....	A-9

- A.3 DXF FilesA-11**
 - DXF Data Supported on This System A-11
 - Conversion of DXF Data Elements A-11
- A.4 ASCII Code TableA-12**
- A.5 Shift-JIS Code TableA-13**
- A.6 List of Display CodesA-23**
 - Date/Time A-23
 - Counter A-24
 - Variable data table A-24
 - Date/Time variable data table A-25
 - Link A-25
 - Control code A-25
- A.7 GS1 Code AI List.....A-26**

Chapter 1

Preparation

This chapter explains an overview of the software used with the fiber laser marker and the information that needs to be understood prior to the first use of the system.

1.1	Overview of Software	1-2
1.2	Basic Knowledge of Marking.....	1-14

1.1 Overview of Software

This section provides an overview of the software used with the Fiber Laser Marker MX-Z2000H-V1 series (hereinafter referred to as “the system”).

Marker Software and Offline Editing Software

The following two types of software are available for the system.

- **Marker software**

These software programs are preinstalled on the system and are the basis for the operations of the system.

When the system power supply is turned ON, the software will start automatically.

Use this to create and edit marking data (Refer to "Explanation of Terms (page 1-17)"), specify system settings, execute/stop marking, monitor the current operation status, etc.

- **Offline editing software**

This software is used to create and edit marking data on a PC.

Install it on a separately arranged PC. (Refer to "Installing and Starting the Offline Editing Software (page 1-3)")

“Font logo editor,” with which fonts and logos can be edited, is built-in on the system.

To transfer marking data between the system and the PC, use USB memory. External storage can be used as the save destination for marking data with file sharing via Ethernet.

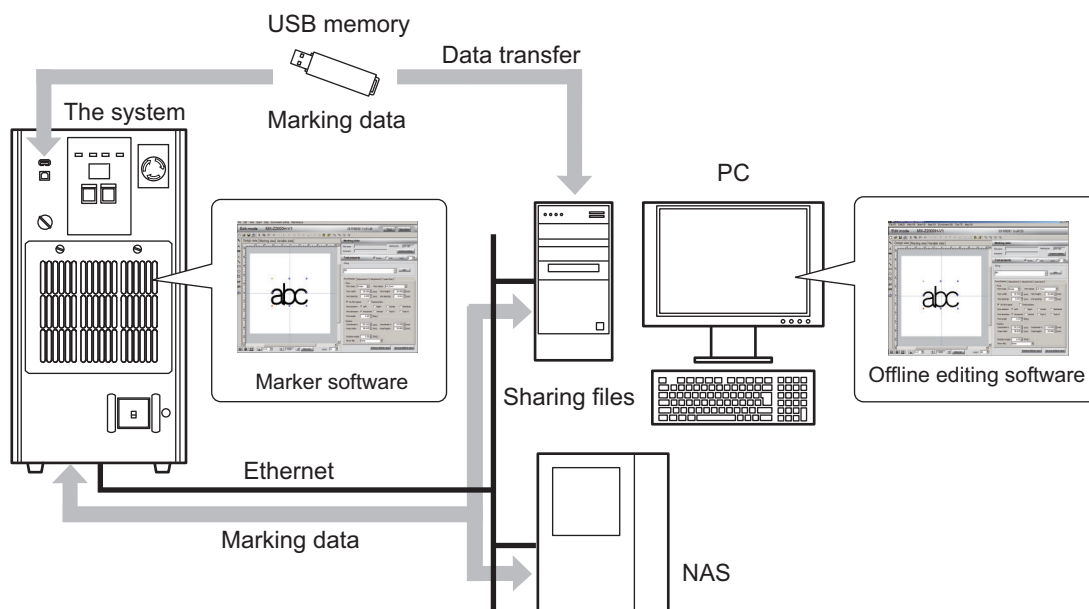

Installing and Starting the Offline Editing Software

The offline editing software installation and startup methods are explained.

■ Operation environment

The following environment is needed to operate the offline editing software.

Prior to installing the software, make sure that the following specifications are met on the PC you are using.

Item	Specification
Applicable model	PC with USB port
Supported OS	Windows®7/Windows®8/8.1/Windows®10
CPU/Memory capacity	According to the OS specification
Available hard disk space	1 GB or more
Display resolution	1,024 × 768 pixels or more (Recommended)

■ Installation method

The procedure for installing the offline editing software is explained.

Although Windows 7 screens are used as an example in this section, the method of installation is the same for other operating systems.

1 Turn the PC power supply ON, and insert the CD-ROM into the PC's CD-ROM drive.

The offline editing software installer will start.

If the installer does not start, double-click "setup.exe" on the CD-ROM to execute it.

2 Click [Next].



3 Select the installation location and click [Next].

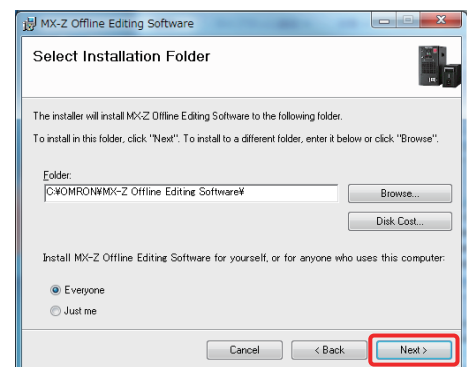



Precautions for Correct Use

Do not change the installation location.

4 Click [Next].

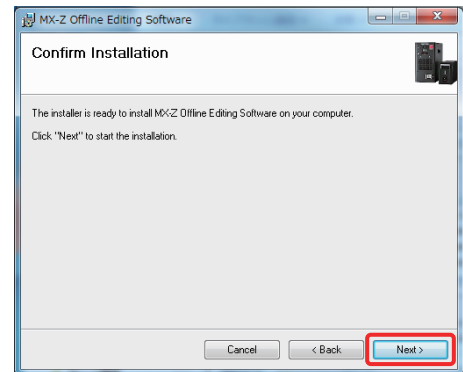

Installation will start.

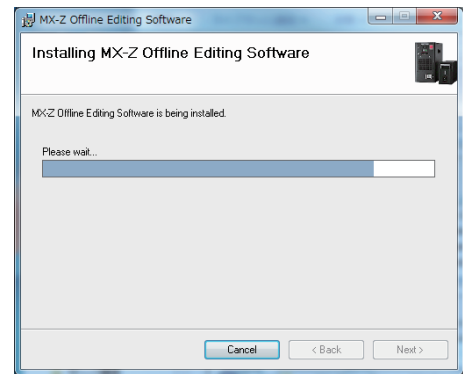

5 When the installation is completed, click [Close].

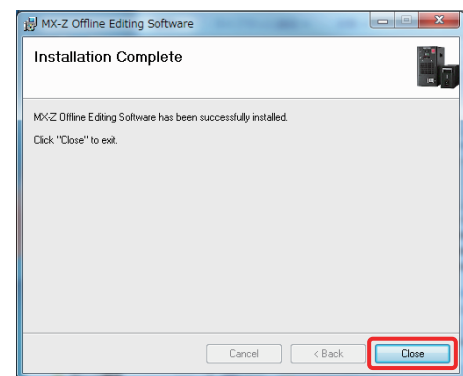

Additional Information

Once the software is installed, the offline editing software and the Font logo editor shortcuts will be automatically created on the PC's desktop.



MX-Z Offline Editing So...



MX-Z Font Logo Editor

■ Uninstallation method

On Windows's [Add or Remove Programs] screen, specify the offline editing software and click [Remove].

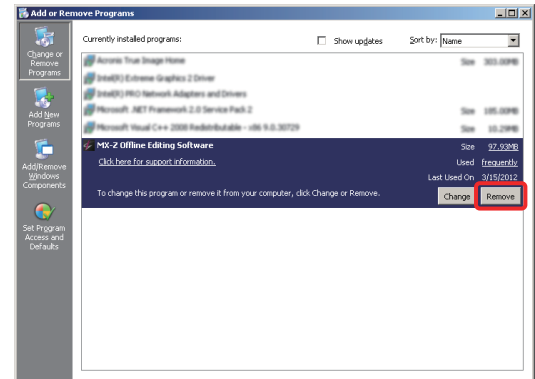

■ Starting the offline editing software

- 1 Double-click the offline editing software shortcut, or select Windows's [Start] - [All Programs] - [OMRON] - [MX-Z Series] - [MX-Z Offline Editing Software].



MX-Z Offline Editing So...

■ Type Setting

Set the target type of laser marker for the data processed with the offline editing software.

- 1 Click [Environment] on the menu bar, and then select [Model].
The [Type setting] dialog box is displayed.

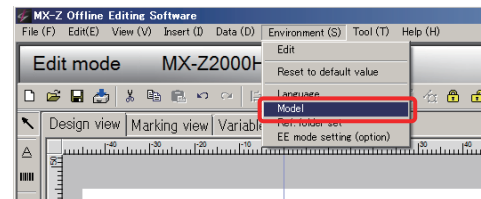

- 2 Select the target model with [Type name] and click [OK].
Restart confirmation message is displayed.

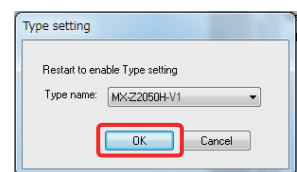

- 3 Click [OK] to close the message.
Manually restart the software.

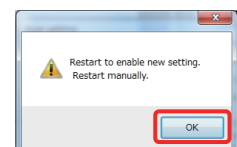

📌 Precautions for Correct Use

If the model is changed, be sure to restart the offline editing software.

Transferring Data

The method of transferring data between the system and the PC via a USB memory is explained.



Precautions for Correct Use

Special USB memory types cannot be used, such as the USB memory with an encryption or other security function and USB memory that creates multiple drives at connection.



Additional Information

If there is a file with the same marking number at the transfer destination, the following dialog is displayed. When switching marking data with communications from an external device, the data is specified by its marking number. Therefore, when operating this way, do not use duplicate marking numbers.

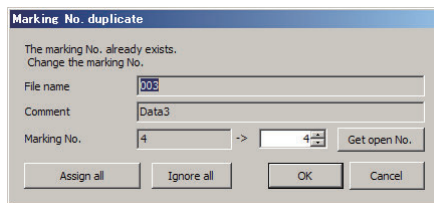

Assign all: Transfers assigning unused numbers automatically to all files with duplicate numbers. (The transfer takes time.)

Ignore all: Transfers all files with duplicate numbers as is. (Marking numbers are duplicated.)

Get open No.: Acquires an unused number. This is used to assign marking numbers manually.

■ Saving the data to the USB memory

Saves the marking data and files created and edited by the system or by the offline editing software to USB memory for data transfer.

Note that data and files that can be transferred from the system or the offline editing software are as follows.

- Marking data
- Part file
- Image file (BMP/JPEG/PNG format)
- Graphic file (DXF file: R12 format/olg)
- Stroke font
- Pattern file (Fill pattern for the [ID code] blocks when [Fill] is set.)
- Counter setting
- Variable data table setting
- Date/Time variable data table setting

Transfer all files that are to be referenced by marking data, such as image and graphic files.



Reference

For details of each item, refer to the corresponding pages.

Additional Information

The save folders of marking datas and part files are as follows. (Default installation folders)

- MX-Z2000

C:\OMRON\MX-Z Offline Editing Software\Bin\Data\

- Except MX-Z2000

<Marking data>

C:\OMRON\MX-Z Offline Editing Software\Bin\Data\Project\ (model)

<Part file>

C:\OMRON\MX-Z Offline Editing Software\Bin\Data\Parts\ (model)

- 1 **Connect the USB memory to which data is to be saved to the [MEMORY] connector on the front face of the controller.**

When using the offline editing software, connect the USB memory to the PC you are using.

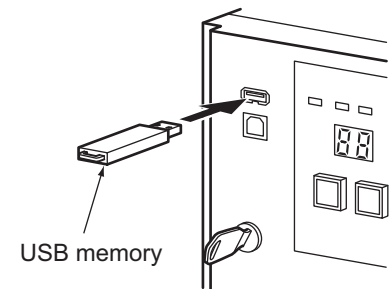

- 2 **Click [File] on the menu bar, and then select [Data transfer].**
The [Data transfer] dialog box is displayed.

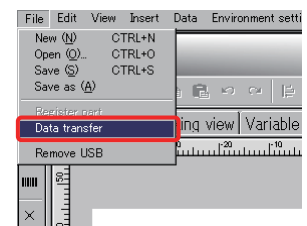

- 3 **Select the types of files to be saved in [Target data] (multiple selection allowed).**

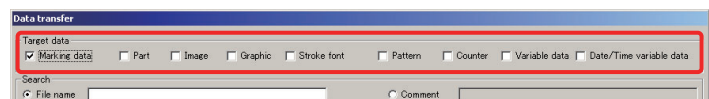

The save data corresponding to the selected file types will be displayed in the [Laser marker unit] list.

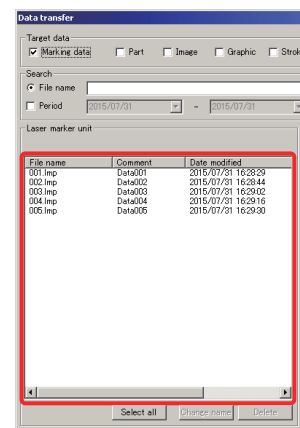



Additional Information

With the [Data transfer] dialog box, you can search file with the method described below.

- Search with file name
- Search with comments saved with the file
- Search with the date (period) of creation
- Search with file name and the date (period) of creation
- Search with comments and the date (period) of creation

You cannot select both [File name] and [Comment] as a search keyword at the same time.

In the [Search] box, select the item that you want to use for the search from above, enter the search keyword and/or period, and then click [search].

You can specify OR and AND conditions. When specifying multiple search keywords, separate the keywords with a comma “,” or semicolon “;”.

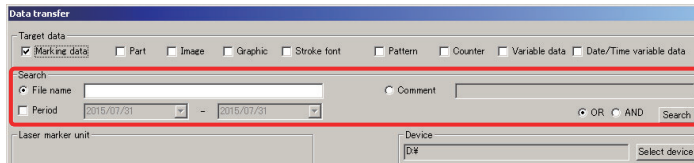

4 Select the data to be saved to the USB memory (multiple selection allowed).

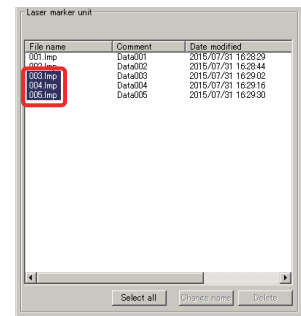

Additional Information

- Click [Select all] to select all data on the list.
- To change the data name, click [Change name] and set the new data name in the [Change data name] dialog box.
- To delete the data from the list, select the data to be deleted and click [Delete], and click [Yes] in the delete confirmation message.

5 Click [Select device] and specify the USB memory drive to which the data is to be saved.

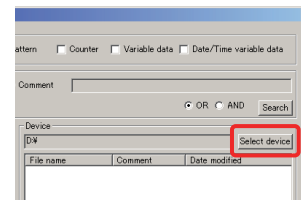

The path for the specified save location will be displayed.

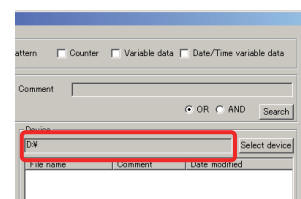

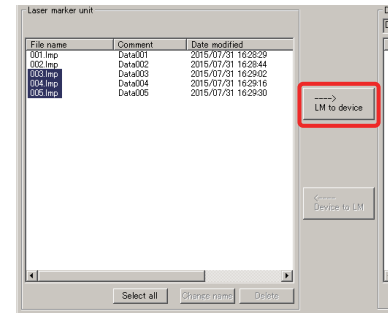
6 Click [LM to device].

1

The [Laser marker unit] list content will be copied to the [Device] list, allowing the data to be saved.

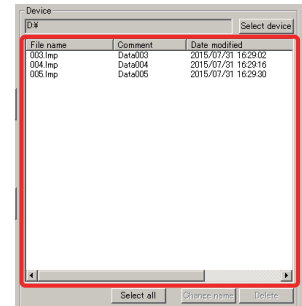

Precautions for Correct Use

Do not turn the power supply OFF after clicking [LM to Device] and while the data is being transferred.

7 Click [Close].

Precautions for Correct Use

When removing the USB memory from the system, do not simply disconnect it, but instead, remove it based on the procedure below. Otherwise, the data on the USB memory may be damaged.

If using the offline editing software, remove the USB memory based on the procedure to remove USB memory from a PC.

8 Click [File] on the menu bar, and then select [Remove USB].

A dialog box indicating that the operation has completed is displayed.

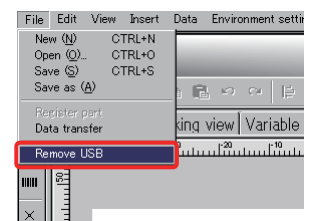
**9 Remove the USB memory from the [MEMORY] connector.**

■ **Installing data to the system or offline editing software**

Installs the marking data and files saved to the USB memory on the system or the offline editing software.

- 1 **Connect the USB memory to which data has been saved to the [MEMORY] connector on the front face of the controller.**
When using the offline editing software, connect the USB memory to the PC you are using.

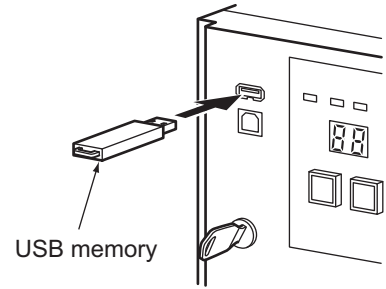

- 2 **Click [File] on the menu bar, and then select [Data transfer].**
The [Data transfer] dialog box is displayed.

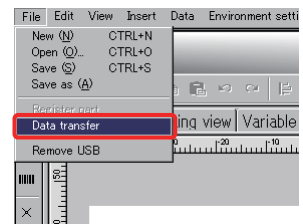

- 3 **Select the types of files to be installed in [Target data] (multiple selection allowed).**

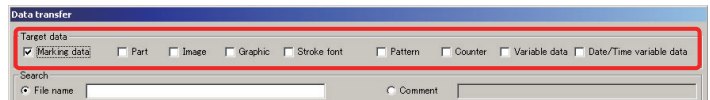

- 4 **Click [Select device] and specify the USB memory drive where files to be installed are saved.**

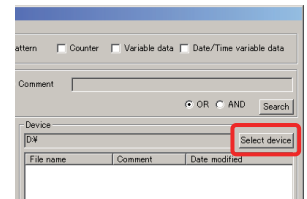

The data corresponding to the selected file types will be displayed in the [Device] list.

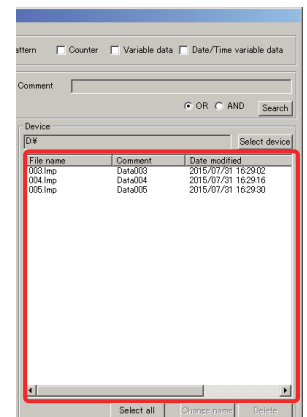

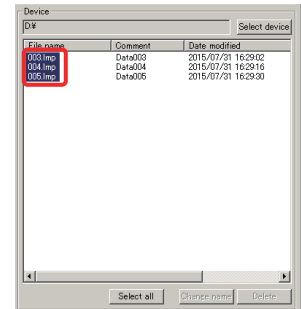
5 Select the data to be installed (multiple selection allowed).

1

Additional Information

- Click [Select all] to select all data on the list.
- To change the data name, click [Change name] and set the new data name in the [Change data name] dialog box.
- To delete the data from the list, select the data to be deleted and click [Delete], and click [Yes] in the delete confirmation message.

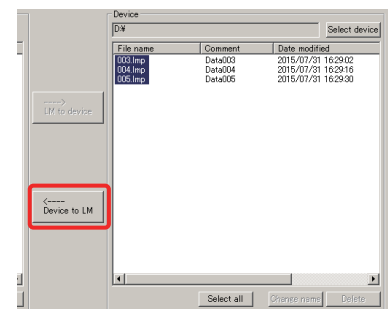
6 Click [Device to LM].

The [Device] list content will be copied to the [Laser marker unit] list, allowing the data to be saved.

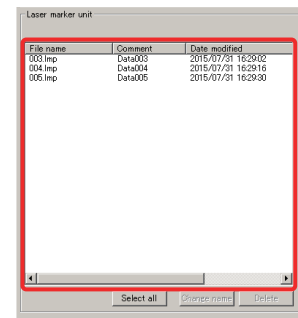

Precautions for Correct Use

Do not turn the power supply OFF after clicking [Device to LM] and while the data is being transferred.

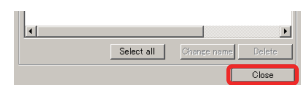
7 Click [Close].

8 Remove the USB memory from the [MEMORY] connector.



Reference

For information on how to remove the USB memory, refer to:

- Steps 8 and on in “Saving the data to the USB memory” (page 1-9)

If using the offline editing software, remove the USB memory based on the procedure to remove USB memory from a PC.

Creating and Editing Data Using Offline Editing Software

Although the offline editing software screens are almost all the same as those of the marker software, some functions are limited.

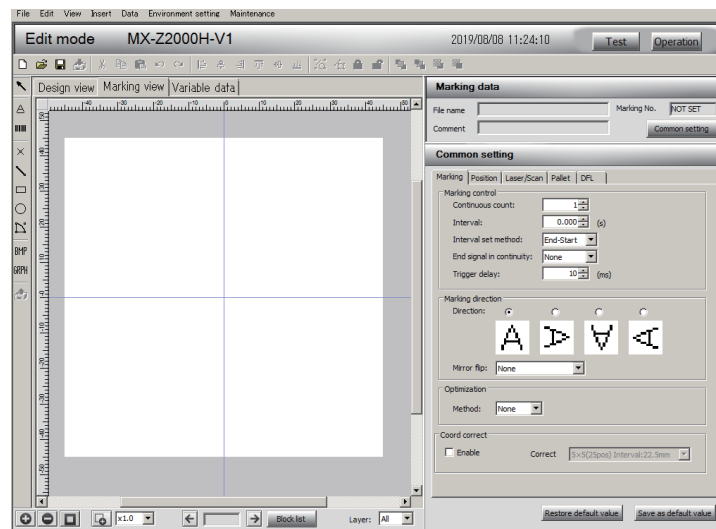

The functions that are available/not available with the offline editing software are as follows.

Item	Marker software	Offline editing software
Operate marking data (file).	Yes	Yes
Create new marking data.	Yes	Yes
Edit existing marking data.	Yes	Yes
Data setting	Yes	Yes
Environment setting	Yes	Some settings are possible
Maintenance/Adjustment	Yes	No
Execute/stop the test marking.	Yes	No
Execute/stop the marking.	Yes	No
Monitor the operation status.	Yes	No
Start the Font logo editor.	No	Yes

Reference

- "A.2 Menu Item List (page A-9)"

1.2 Basic Knowledge of Marking

This section explains concepts and terminology that need to be understood when using the system.

Edit Mode and Operation Mode

The marker software consists of the following two modes, and the corresponding screen is provided for each mode.

Note that the screens can be switched between the two with a click of the button.

- Edit mode

The mode is used to create new marking data, edit existing marking data, and set marking conditions and operating environment settings, etc.

You can also perform “Test marking” in which marking data can be checked with the guide laser or actual laser.

- Operation mode

The mode is used to instruct to start/stop marking based on the specified marking data.

The current marking condition can be monitored during marking.

Note also that the error status is displayed when an error occurs during marking.

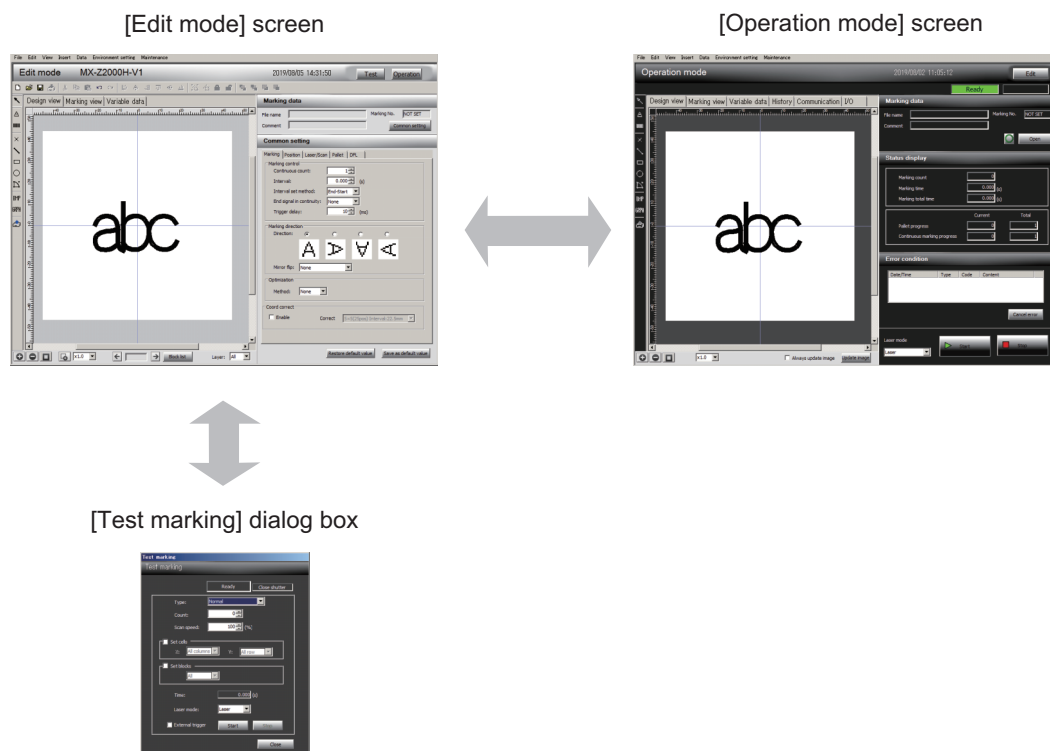

You can specify in which screen mode to start the system. (Refer to "■ Setting at startup (page 1-15)")

■ Setting at startup

Prior to using the marker software, have the system startup settings specified in advance. Specify the settings in the edit mode.

- 1 Click **[Environment setting]** on the menu bar, and then select **[Marker operation]**.

The **[Marker operation setting]** dialog box is displayed.

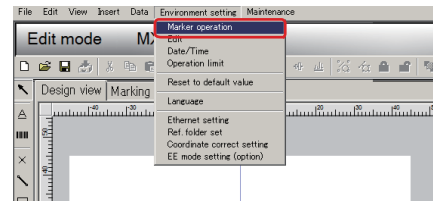

- 2 Select the **[Start setting]** tab and select the following items.

(1) Date setting

When marking "Week" in date and time, sets the starting day of the week.

(Refer to "■ [Date/Time] tab setting items in the [Edit] dialog box (page 2-32)")

- Sunday: Sunday is set as the starting day of the week.
- Monday: Monday is set as the starting day of the week.

(2) Mode

Sets the operation mode of the marker software when starting the system.

- Operation mode: The software is started in the [Operation mode] screen.
- Edit mode: The software is started in the [Edit mode] screen.

(3) Specify marking data

When starting the system, selects the checkbox to open the specified marking data.

- Spec. user
Specifies the marking data to be opened at start. The marking data is specified by directly entering the file name in [File name] or clicking [Browse] to display the [Select marking data] dialog box.
- Last used file
At starts, opens the marking data that was being used at the end of the last session.

(4) Change lock

In the [Operation mode] screen, specifies whether or not to lock [Open] in the marking data information display area (by turning ON/OFF the lock button). (Refer to "4.3 Loading the Marking Data (page 4-5)")

- Yes: When the system, after started, transitions to the [Operation mode] screen, the lock button will be locked (marking data cannot be opened).
- No: When the system, after started, transitions to the [Operation mode] screen, the lock button will be unlocked.

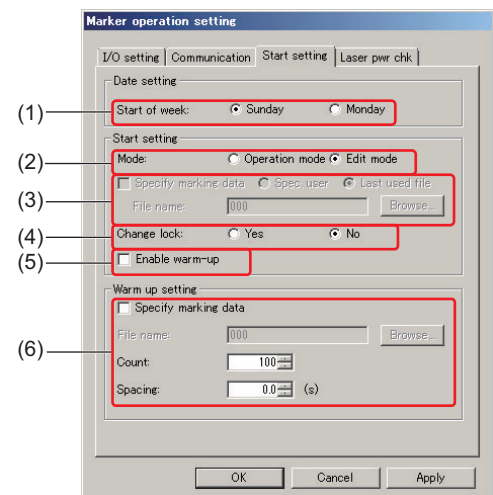

(5) Enable warm-up

This checkbox is selected to enable the system to automatically warm up when it transitions to the operation mode upon its start.

Error 0026 will occur when switching to operation mode while the key switch is turned OFF.

(6) Warm up setting

Sets the warm-up content when the [Enable warm-up] checkbox is selected.

- Specify marking data: This checkbox is selected to specify the marking data to be used for warm up.
When this is cleared, the warm up will be performed based on the preset system conditions.
- File name: Sets the marking data to be used for warm up when the [Specify marking data] checkbox is selected.
The marking data is specified by directly entering the file name or clicking [Browse] to display the [Select marking data] dialog box.
- Count: Sets the number of times warm up is to be executed.
- Spacing: Sets the warm up spacing (Unit: seconds).



Additional Information

While the marker software is running, warm-up can be manually executed at any time. (Refer to "7.3 Warm Up (page 7-7)")

3 When the setting has been completed, click [OK].

The [Marker operation setting] dialog box is closed.

Explanation of Terms

■ Marking data

Marking-related data are created individually for the work (target) to be marked, and saved to the system's storage.

Specify and load marking data for each task to be executed each time when performing marking.

This system can create a maximum of 10,000 sets of marking data (marking data number 0000 to 9999) and assign any file name and comment to each.

Marking data include “block data,” such as text, bar code, straight line, block shape or positional “block setting,” and “common settings,” such as marking control method and layer settings.

Note that data settings such as data table and counter, and system-related settings such as environment settings, and maintenance and adjustment, are not included in marking data information.

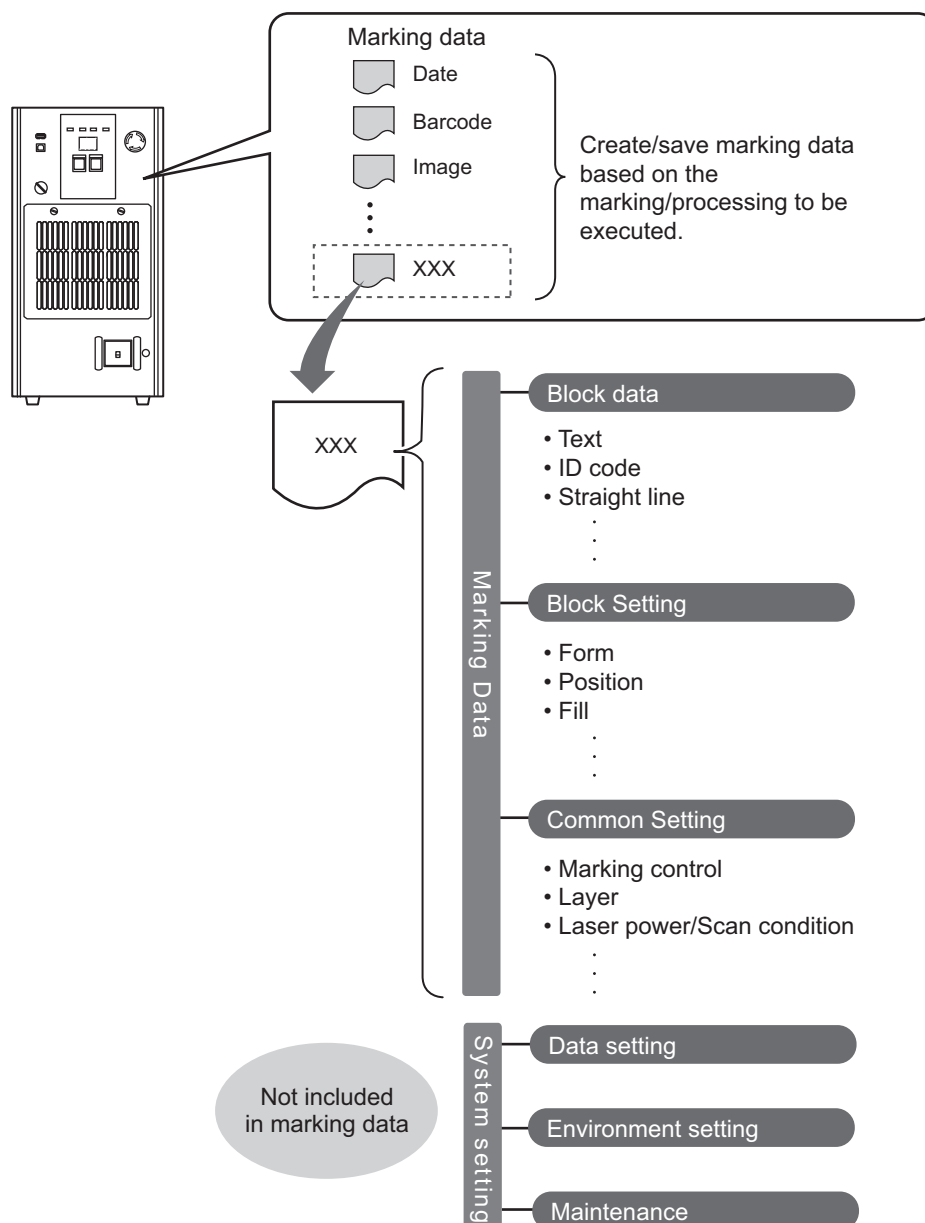

Additional Information

The marking data for MX-Z2000H-V1 and MX-Z2050H-V1/Z2055H-V1 is completely compatible.

■ Sheet and block data

The blank area on the left side of the software is called a “sheet.”

The range of the sheet directly represents the range (MX-Z2000H-V1: 90 × 90 mm / MX-Z2050H-V1/Z2055H-V1: 160 × 160 mm) that can be marked in the system.

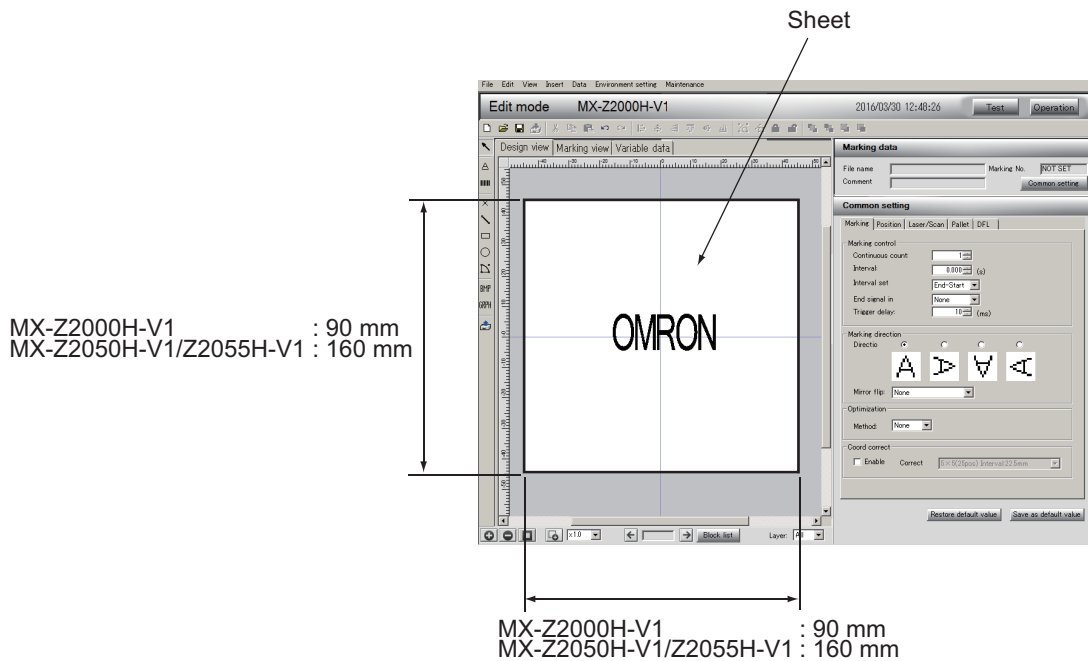

To create data to be marked, draw or place text or shape on the sheet.

Each element that was drawn or placed, such as text and shape, is called “block” and it constitutes the data to be marked.

For example, in a marking operation below, “ABC,” “123” and the bar code are all individual block data each.

On this system, up to 2,048 sets (block Nos. 0000 to 2047) of block data can be created.

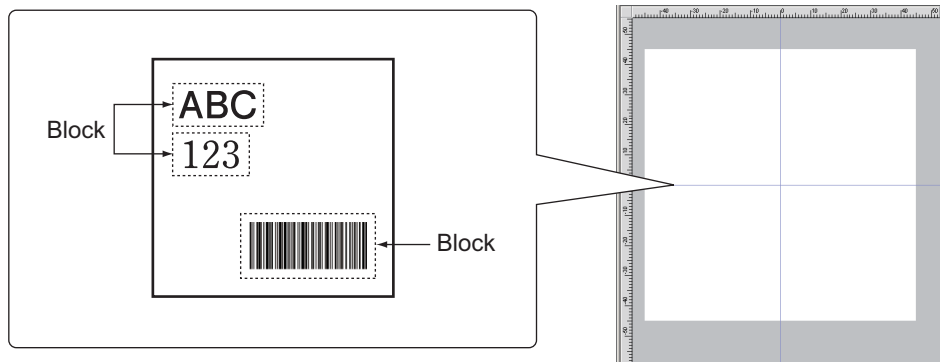

■ Layer

A “layer” refers to a layered sheet.

Up to 8 layers can be created per marking data, and marking position can be corrected for each layer individually.

For example, when marking a surface of a work shaped as shown in the figure below, marking layer for each surface is set individually, and the position is corrected individually for each layer.

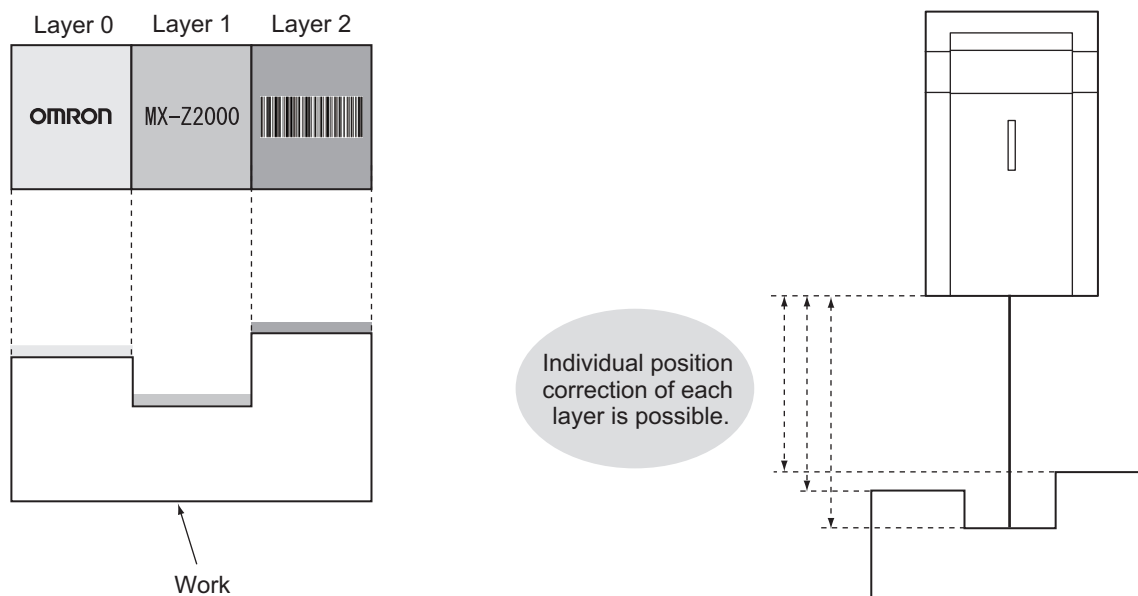

1 Preparation

Also, for work with column, conical, and spherical shapes shown in the figure below, curved surfaces can also be marked by setting the work radius and number of divisions of the surface. Position correction is also possible for X, Y, Z axes and θZ .

- Column external (X axis direction)

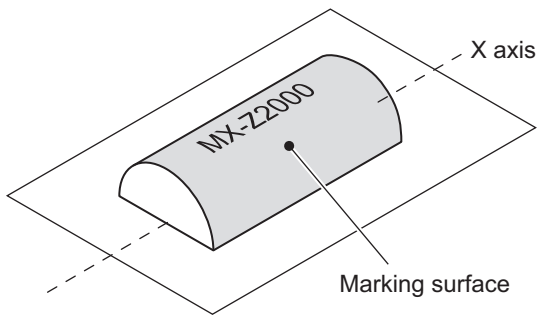

- Column external (Y axis direction)

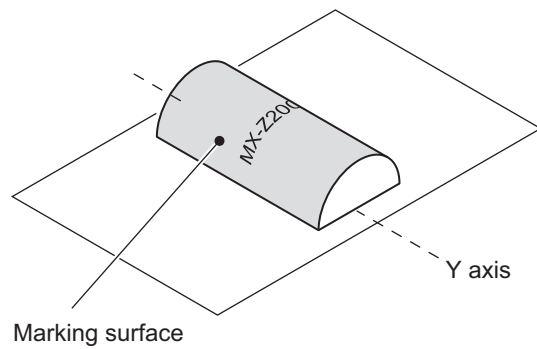

- Column internal (X axis direction)

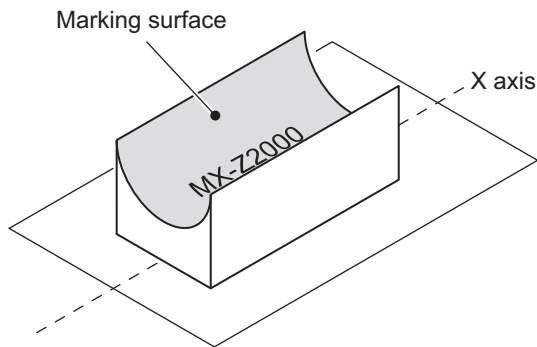

- Column internal (Y axis direction)

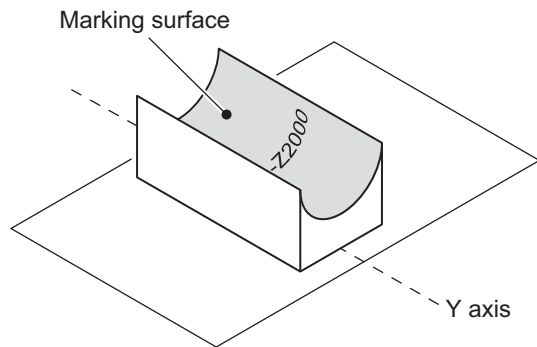

- Cone external (X axis right vertex, Placed directly)

Right vertex:
This setting places the cone vertex in the positive direction of the X axis (right side). Left vertex can also be selected.

Placed directly:
The cone is placed directly on the work surface. The sloped surface of the cone is set as the marking surface.

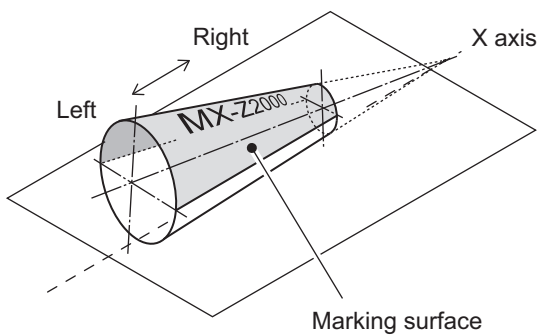

- Cone external (X axis right vertex, Marking surface horizontal)

Right vertex:
This setting places the cone vertex in the positive direction of the X axis (right side). Left vertex can also be selected.

Marking surface horizontal:
The cone is placed on the work surface in such a way that the upper oblique line of the cone is horizontal. The sloped surface of the cone is set as the marking surface.

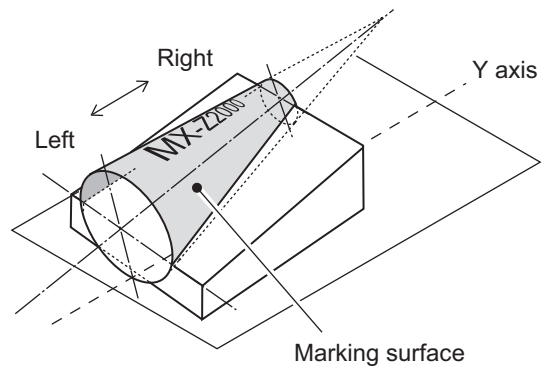

- Cone external (X axis right vertex, Semi-cone)

Right vertex: This setting places the cone vertex in the positive direction of the X axis (right side). Left vertex can also be selected.

Semi-cone:

The semi-cone divided with a center line is placed directly on the work surface. The sloped surface of the semi-cone is set as the marking surface.

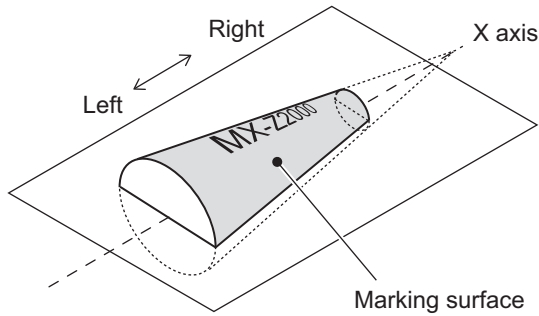

- Cone external (Y axis top vertex, Placed directly)

Top vertex: This setting places the cone vertex in the positive direction of the Y axis (top side). Bottom vertex can also be selected.

Placed directly:

The cone is placed directly on the work surface. The sloped surface of the cone is set as the marking surface.

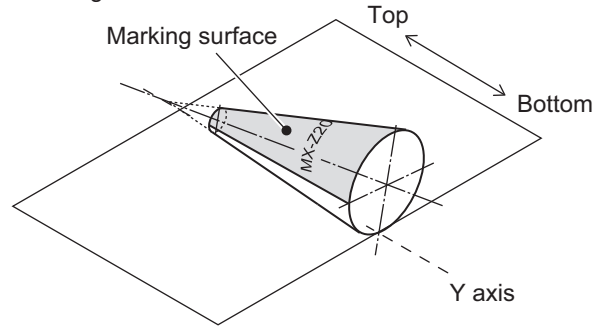

- Cone external (Y axis top vertex, Marking surface horizontal)

Top vertex: This setting places the cone vertex in the positive direction of the Y axis (top side). Bottom vertex can also be selected.

Marking surface horizontal:

The cone is placed on the work surface in such a way that the upper oblique line of the cone is horizontal. The sloped surface of the cone is set as the marking surface.

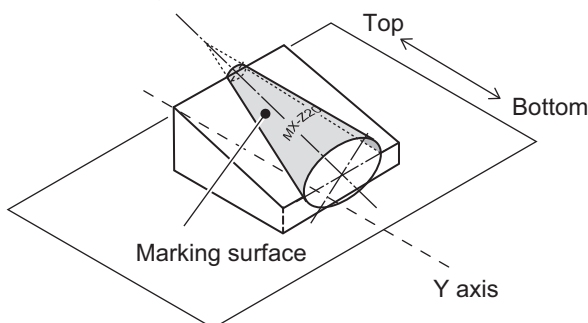

- Cone external (Y axis top vertex, Semi-cone)

Top vertex: This setting places the cone vertex in the positive direction of the Y axis (top side). Bottom vertex can also be selected.

Semi-cone:

The semi-cone divided with a center line is placed directly on the work surface. The sloped surface of the semi-cone is set as the marking surface.

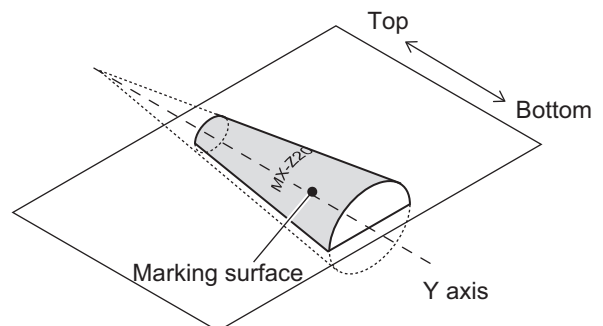

- Cone external (Z axis vertex)

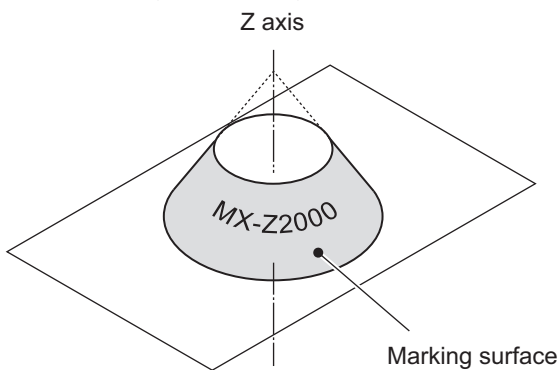

- Cone internal (Z axis vertex)

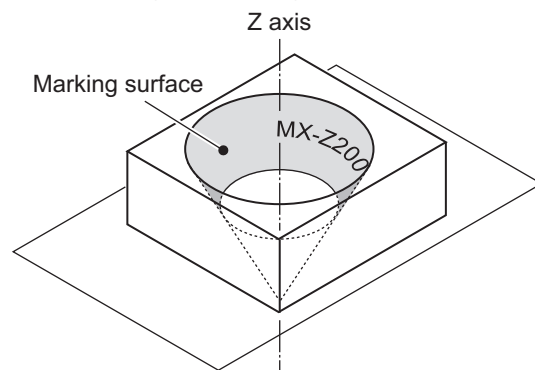

1 Preparation

- Cone internal
(X axis right vertex, Placed directly)

Right vertex: This setting places the cone vertex on the right side of the axis. Left vertex can also be selected.

Placed directly:

The cone is placed directly on the work surface. The sloped surface of the cone is set as the marking surface.

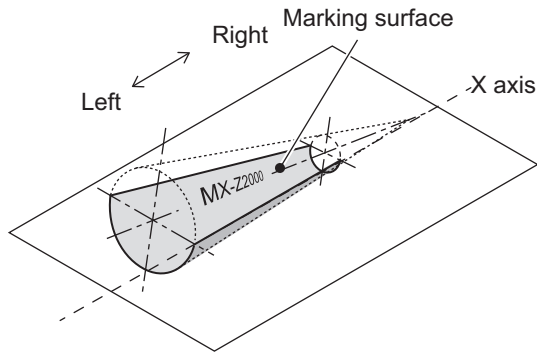

- Cone internal
(X axis right vertex, Semi-cone)

Right vertex: This setting places the cone vertex on the right side of the axis. Left vertex can also be selected.

Semi-cone:

The semi-cone divided with a center line is placed directly on the work surface. The sloped surface of the semi-cone is set as the marking surface.

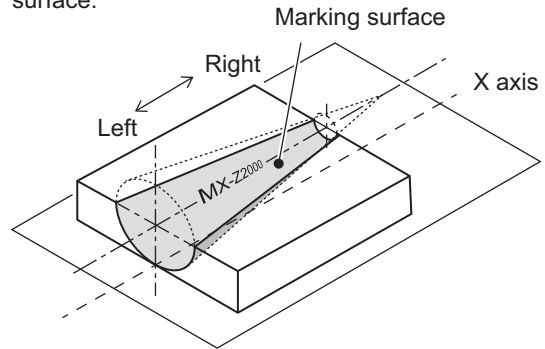

- Cone internal
(Y axis top vertex, Placed directly)

Top vertex: This setting places the cone vertex in the positive direction of the Y axis (top side). Bottom vertex can also be selected.

Placed directly:

The cone is placed directly on the work surface. The sloped surface of the cone is set as the marking surface.

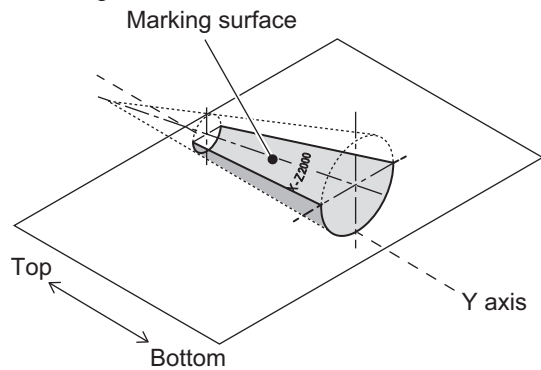

- Cone internal
(Y axis top vertex, Semi-cone)

Top vertex: This setting places the cone vertex in the positive direction of the Y axis (top side). Bottom vertex can also be selected.

Semi-cone:

The semi-cone divided with a center line is placed directly on the work surface. The sloped surface of the semi-cone is set as the marking surface.

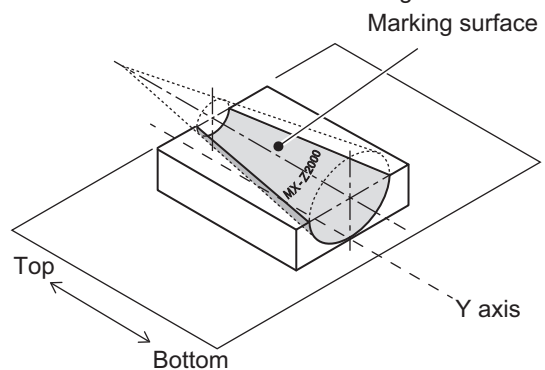

- Sphere external

Marking surface

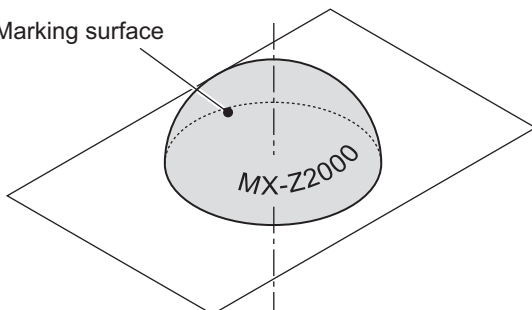

- Sphere internal

Marking surface

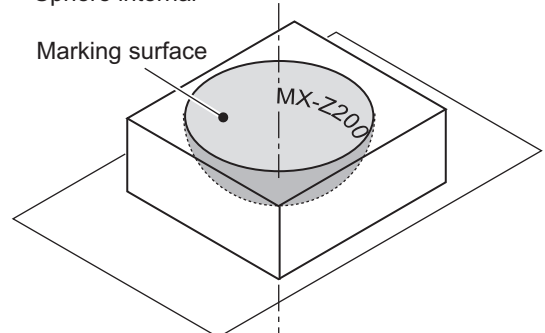

Efficient marking can be achieved by using the layer function according to the work shape as explained above.

◆ Focus pointer alignment location

Layer shape external

The layer shape external only displays the range that can be marked of the shape of the surface above the reference. Align the focus pointer on the upper surface of the range that can be marked.

- Column external (X axis direction)

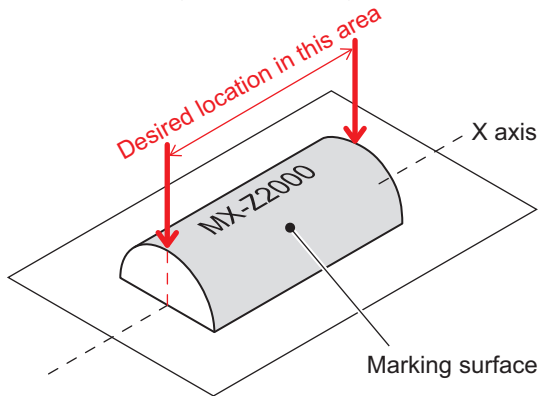

- Sphere external

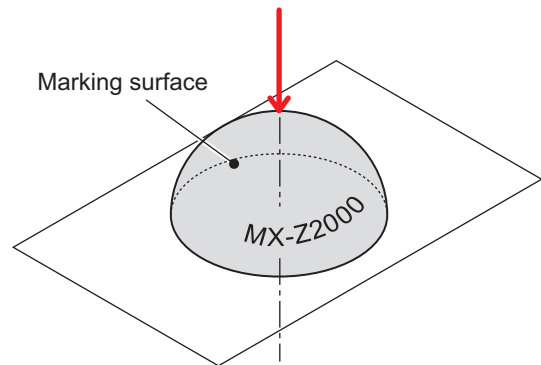

- Cone external (X axis right vertex, Marking surface horizontal)

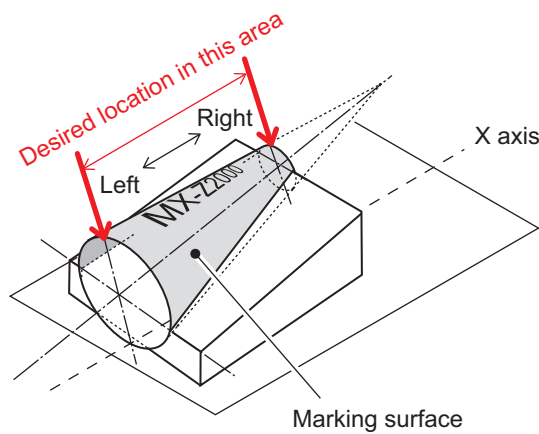

- Cone external (X axis right vertex, Placed directly)
- Cone external (X axis right vertex, Semi-cone)

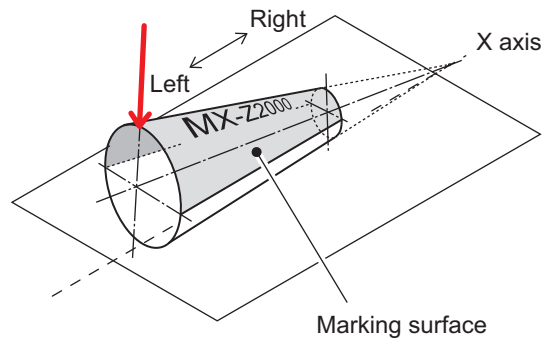

- Cone external (Z axis vertex)

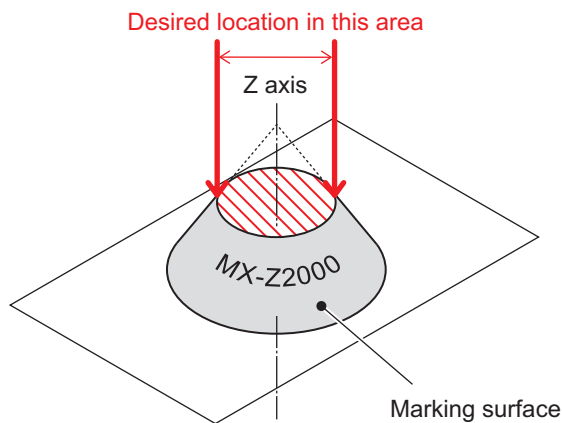

Layer shape internal

The layer shape internal only displays the range that can be marked of the shape of the surface below the reference. Align the focus pointer on the lower surface of the range that can be marked.

- Column internal (X axis direction)

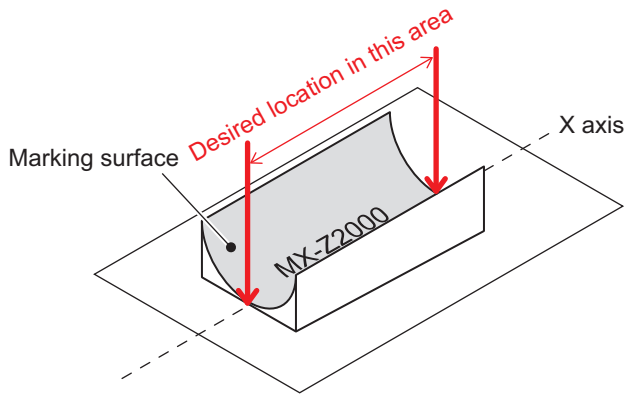

- Sphere internal

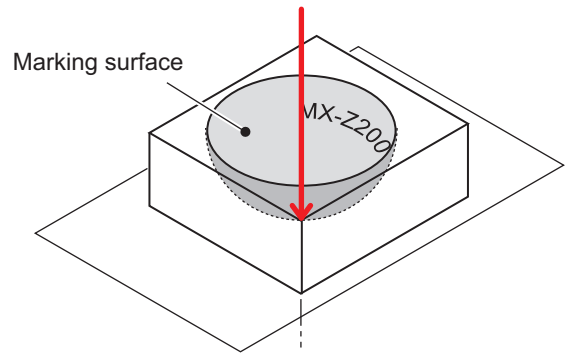

- Cone internal (X axis right vertex, Placed directly)

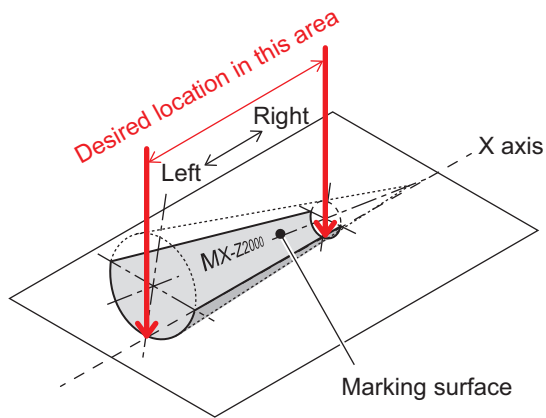

- Cone internal (X axis right vertex, Semi-cone)

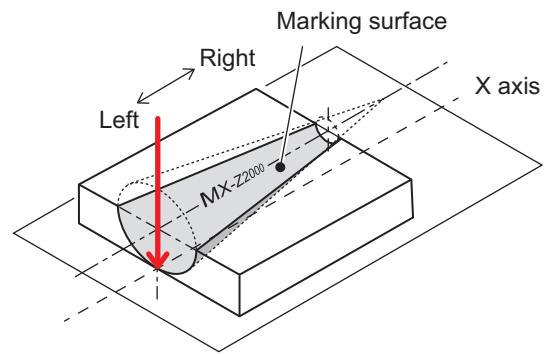

- Cone internal (Z axis vertex)

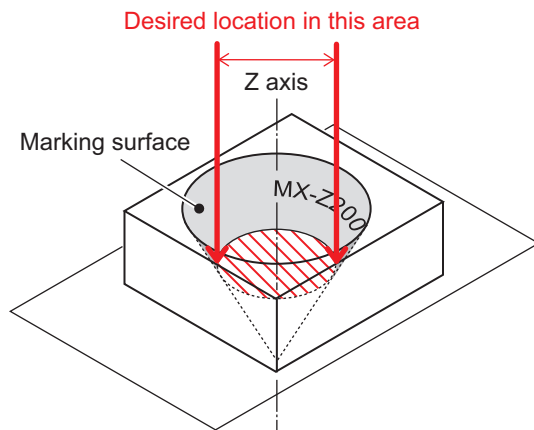

Reference

- "2.7 Common Setting (page 2-108)"

■ Pallet

Marking the same content to multiple cells that are placed on one pallet in a form of a matrix is called “pallet marking.”

In pallet marking, the individual cell placement information on one pallet (cell count and spacing) is called “pallet data,” and the data marked to each cell is called “cell data.”

Cell data include a single or multiple blocks.

The cell placement information on the pallet is handled in units of “rows” (vertical direction) and “columns” (lateral direction), and the numbers of rows and columns are to be specified to set the cell array to perform actual pallet marking.

On this system, cells of up to 255 (rows) × 255 (columns) can be created.

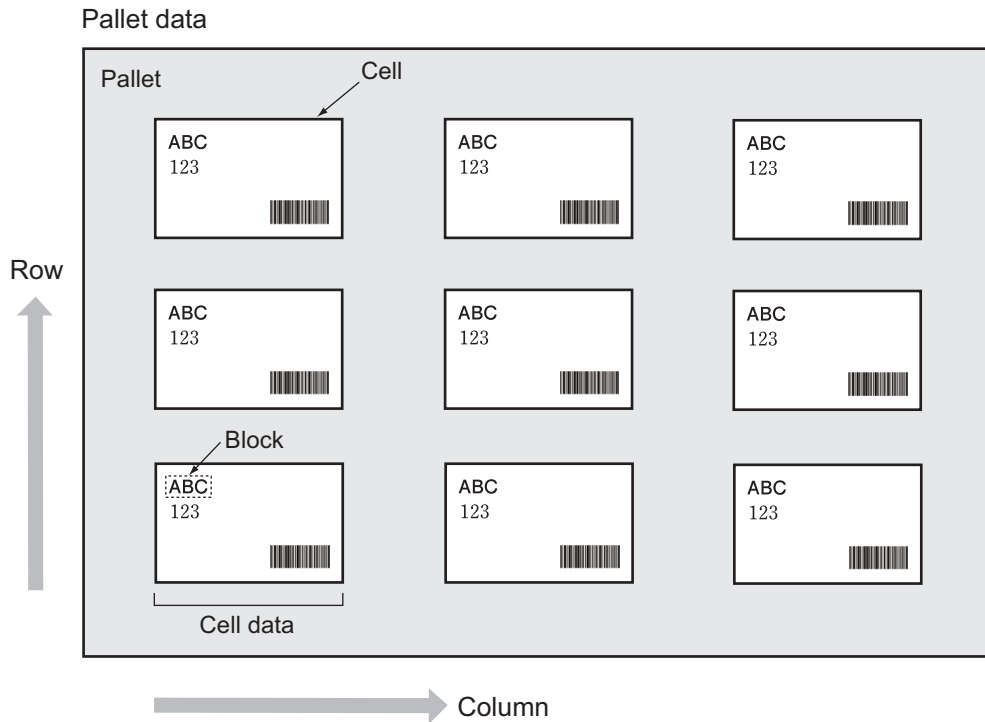

DFL (Direct Finder Link)

The laser marker issues an inspection command to the vision sensor via EtherNet/IP™ message communication to control the vision sensor.

The following is possible using DFL:

- Marking position correction
Correct the marking position according to the information on the marking target position change (X, Y, θ) received from the vision sensor FH.
- 2D code inspection
After marking, perform a reading test on the marking target (2D code) with the vision sensor FH. If the code is unreadable, it is notified that an error occurred. If it is readable, the operation is continued.



Reference

For details of DFL setting item, refer to:

- "2.7 Common Setting (page 2-108)"

For details on the case where the laser marker received an error notification, refer to:

- "Fiber Laser Marker MX-Z2000H-V1 Series Setup Manual" (Z415)

For information on general usage of the vision sensor FH and operation procedures, refer to:

- "Vision System FH/FZ5 Series User's Manual" (Z340)

For information on how to register inspections configured on the vision sensor FH and their details, refer to:

- "Vision System FH/FZ5 Series Processing Item Function Reference Manual" (Z341)
- "Vision System FH/FZ5 Series User's Manual for Communications Settings" (Z342)

For information on general usage of the vision sensor FQ2 and operation procedures, refer to:

- "Smart Camera FQ2-S/CH Series User's Manual" (Z337)

For details on how to register each inspection configured on the visual sensor FQ2 and communication settings, refer to:

- "Smart Camera FQ2-S/CH Series User's Manual - Communication Settings" (Z338)
-



Precautions for Safe Use

- DFL is enabled during operation mode only. The vision sensor is not controlled during test marking.
 - Marking position correction is enabled only when the connected device is FH.
 - To execute marking position correction or 2D code inspection, it is necessary to first configure on the vision sensor. Configure the inspection description setting, communication setting and calibration setting in advance.
-



Additional Information

- To use the DFL, the finder function option (sold separately) is required. For details on the finder function option, refer to "MX-915□ Camera Attachment Setup Manual" (Z382).
 - To use the DFL, the vision sensor the vision sensor FH (sold separately) or the vision sensor FQ2 (sold separately), camera and other devices are required.
-

■ Marking position correction

The marking position is corrected according to the vision sensor FH search results and marking is performed.

Marking position correction can be used to the following targets:

- Block
- Layer
- Position correction



Additional Information

- During marking position correction for blocks, they are rotated by using the reference point of the block as a pivot.
- During marking position correction for layers and position correction, layers and position-corrected marking data is rotated by using the origin of the marking area as the reference.

● Operation flow diagram

- (1) Marking start command issued
The laser marker starts to mark.
- (2) Scene switch requested
The laser marker requests a scene change to the FH.
- (3) Scene switched
The FH changes the scene to the scene number requested at (2).
- (4) Response sent
The results of (3) from the FH are sent to the laser marker.
* When an error signal is notified from the FH, the laser marker judges that it is an error and stops the operation.
- (5) Inspection requested
The laser marker requests a check of the scene selected at (2) to the FH.
- (6) Inspection performed
The FH performs the check requested at (5).
- (7) Inspection result sent
The results of (6) from the FH are sent to the laser marker.
* When an error signal is returned from the FH, the laser marker judges that it is an error and stops the operation.
- (8) Inspection result reflected
According to the results of (7), the laser marker executes marking position correction.
- (9) Laser beam emitted
Laser marker emits a laser.

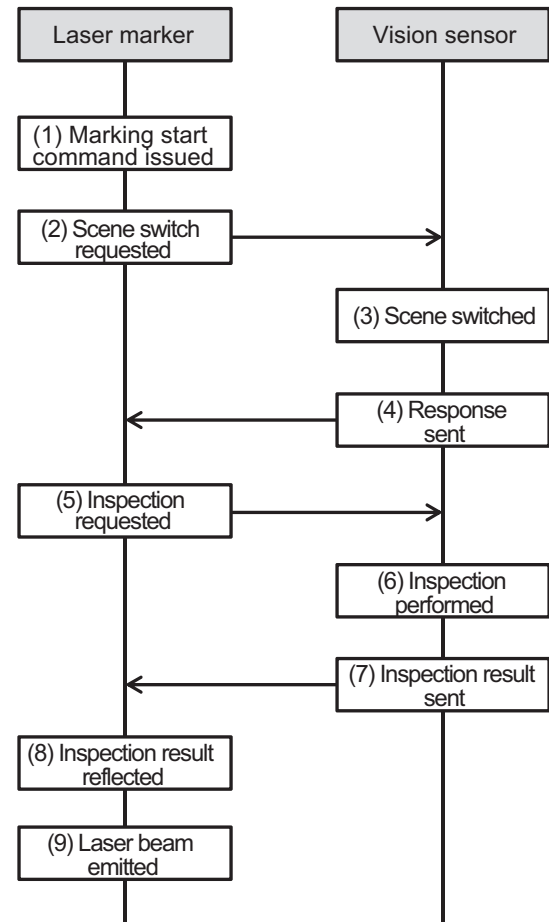

■ **2D code inspection**

The vision sensor implements inspection to judge whether the marked 2D code can be read.



Precautions for Correct Use

The inspection cannot be performed on the 2D code printed outside of the inspection range set on the vision sensor side beforehand.

● **Operation flow diagram**

- (1) Marking start command issued
The laser marker starts to mark.
- (2) Laser beam emitted
Laser marker emits a laser.
- (3) Scene switch requested
The laser marker requests a scene change to the vision sensor.
- (4) Scene switched
The vision sensor side changes the scene to the scene number requested at (3).
- (5) Response sent
The results of (4) from the vision sensor are sent to the laser marker.
* When an error signal is notified from the vision sensor, the laser marker judges that it is an error and stops the operation.
- (6) Inspection requested
The laser marker requests a check of the scene selected at (3) to the vision sensor.
- (7) Inspection performed
The vision sensor performs the check requested at (6).
- (8) Inspection result sent
The results of (7) from the vision sensor are sent to the laser marker.
- (9) Inspection result evaluated
According to the results of (8), the laser marker judges the check results.
* If an error is notified in this processing, whether to continue or stop is selected through the [Read failure operation].

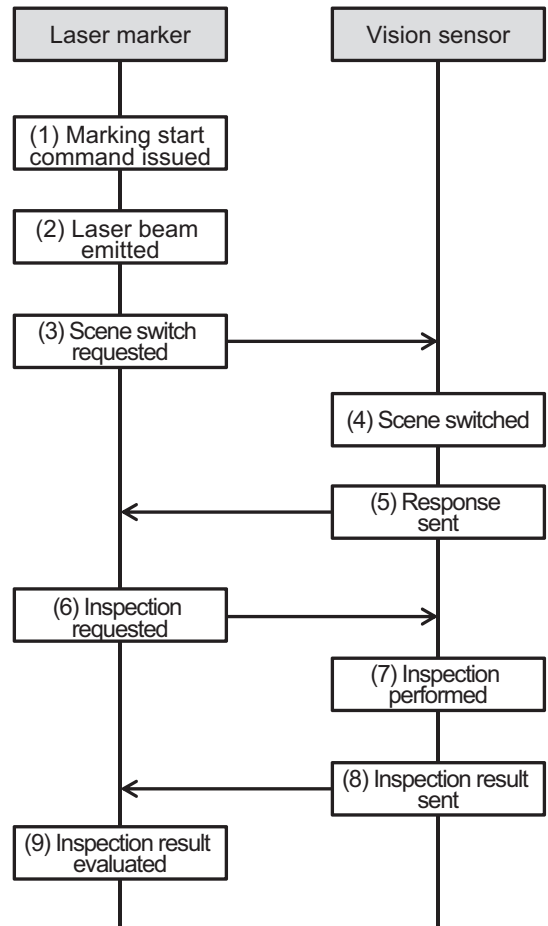

■ Marking position correction and 2D code inspection linking

According to the search results of the vision sensor FH, the laser marker corrects the marking position and performs marking. Afterwards, the laser marker judges whether the 2D code marked by FH can be read.

● Operation flow diagram

- (1) Marking start command issued
The laser marker starts to mark.
- (2) Scene switch requested
The laser marker requests a scene change to the FH.
- (3) Scene switched
The FH changes the scene to the scene number requested at (2).
- (4) Response sent
The results of (3) from the FH are sent to the laser marker.
* When an error signal is notified from the FH, the laser marker judges that it is an error and stops the operation.
- (5) Inspection requested
The laser marker requests a check of the scene selected at (2) to the FH.
- (6) Inspection performed
The FH performs the check requested at (5).
- (7) Inspection result sent
The results of (6) from the FH are sent to the laser marker.
* When an error signal is notified from the FH, the laser marker judges that it is an error and stops the operation.
- (8) Inspection result reflected
According to the results of (7), the laser marker executes marking position correction.
- (9) Laser beam emitted
Laser marker emits a laser.
- (10) Scene switch requested
The laser marker requests a scene change to the FH.
- (11) Scene switched
The FH changes the scene to the scene number requested at (10).
- (12) Response sent
The results of (11) from the FH are sent to the laser marker.
* When an error signal is notified from the FH, the laser marker judges that it is an error and stops the operation.
- (13) Inspection requested
The laser marker requests a check of the scene selected at (10) to the FH.
- (14) Inspection performed
The FH performs the check requested at (13).
- (15) Inspection result sent
The results of (14) from the FH are sent to the laser marker.
- (16) Inspection result reflected
According to the results of (15), the laser marker judges the check results.
* If an error is notified in this processing, whether to continue or stop is selected through the [Read failure operation].

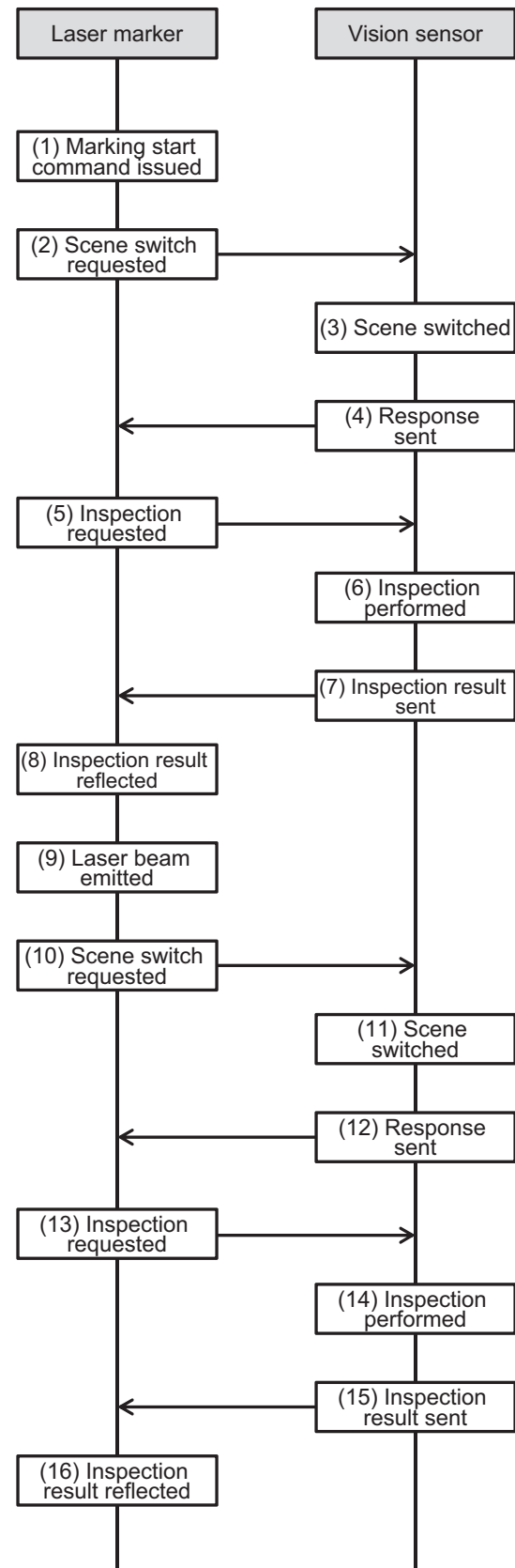

Block Types

When creating marking data, first select the block based on the content to be marked to set the marking content, and specify advanced settings, such as the shape and position, accordingly.

The types of blocks and marking content that can be set on the system are as follows.

■ [Text] block

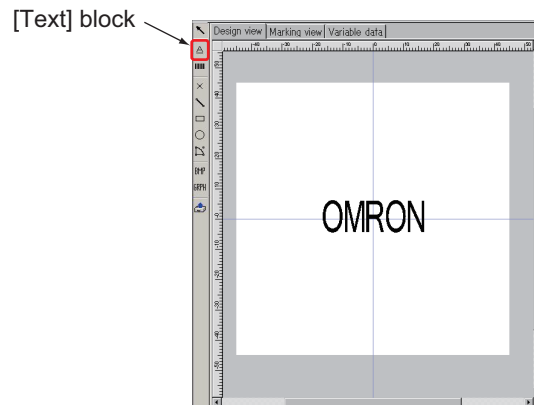

Mark a string.

The following are also marked on this block.

- Date/Time
- Counter

The marking content can be changed using the variable data table and the date/time variable data table.



Reference

-
- "5.4 Variable Data Table Setting Function (page 5-17)"
 - "5.5 Date/Time Variable Data Table Setting Function (page 5-30)"
-

■ [ID code] block

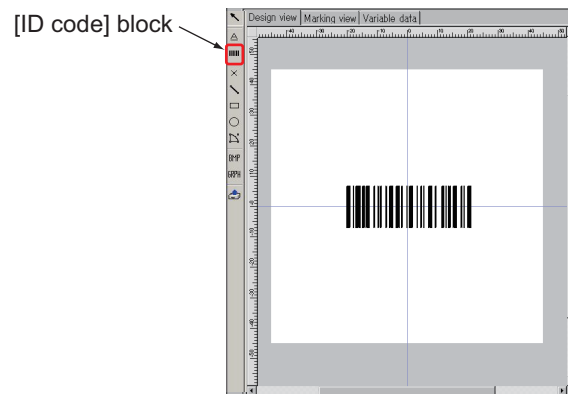

Mark a bar code or a 2D code.
The following codes can be marked.

● Bar code

- EAN (JAN) -8
- EAN (JAN) -13
- Codebar (NW-7)
- ITF
- Code39
- Code128
- GS1 Databar

● 2D code

- QR code
- Data Matrix
- GS1 Data Matrix

■ [Fixed point] block

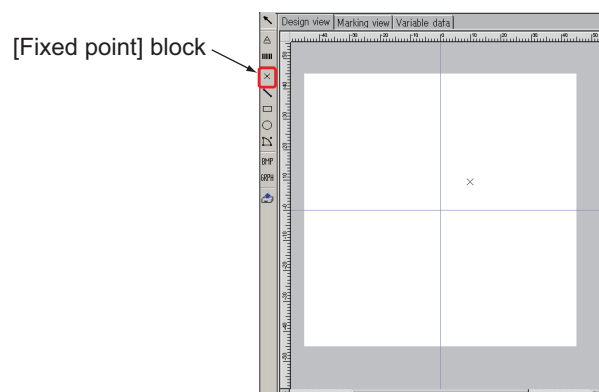

Mark a specified position (fixed point).

■ [Line] block

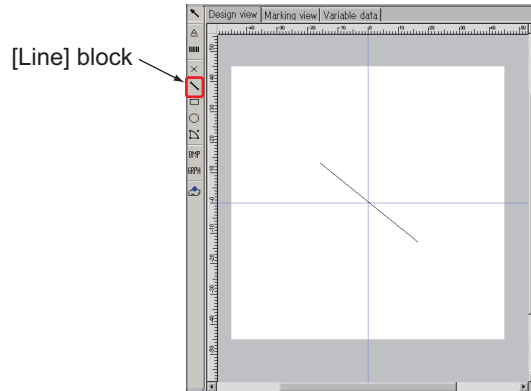

Mark a straight line from the specified start point to the end point (broken line can also be used).

■ [Rectangle] block

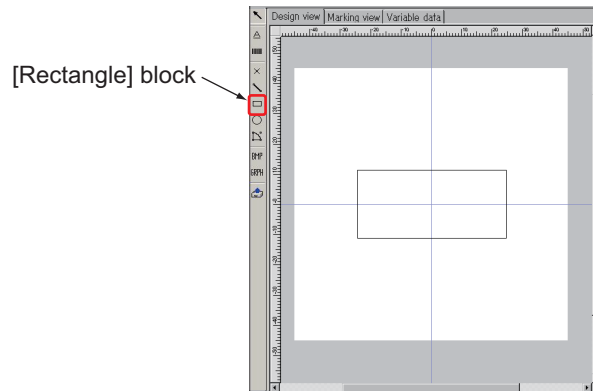

Mark a rectangle (box shape) (broken line can also be used).

■ [Circle] block

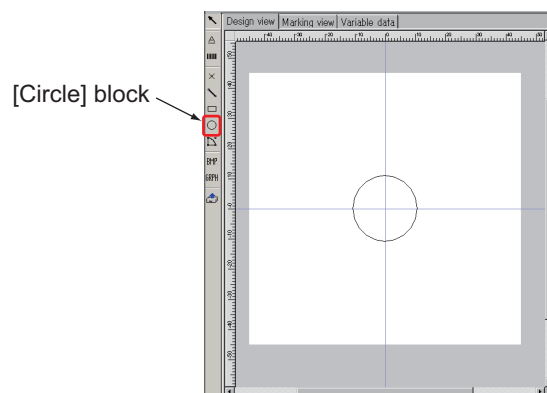

Mark a circle (broken line can also be used).

■ [Arc] block

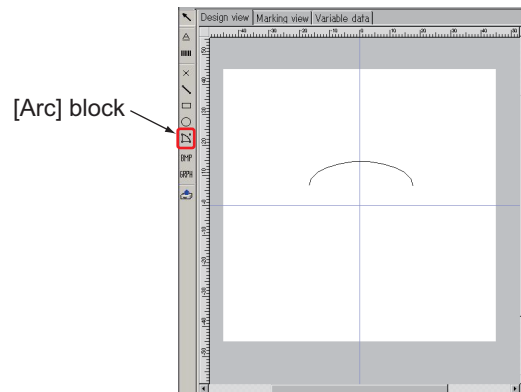

Mark an arc (broken line can also be used).

■ [Image] block

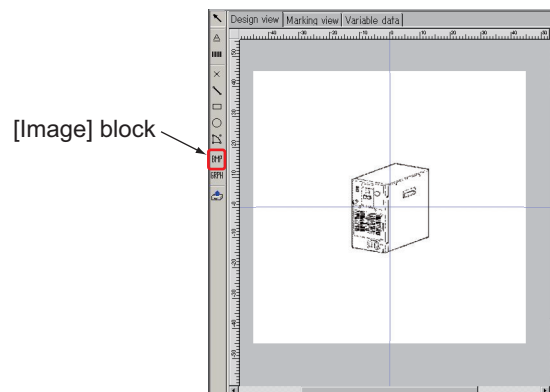

Marks an image file (BMP/JPEG/PNG format).

The marking content can be changed using the variable data table and the date/time variable data table.

Reference

- "5.4 Variable Data Table Setting Function (page 5-17)"
- "5.5 Date/Time Variable Data Table Setting Function (page 5-30)"

■ [Graphic] block

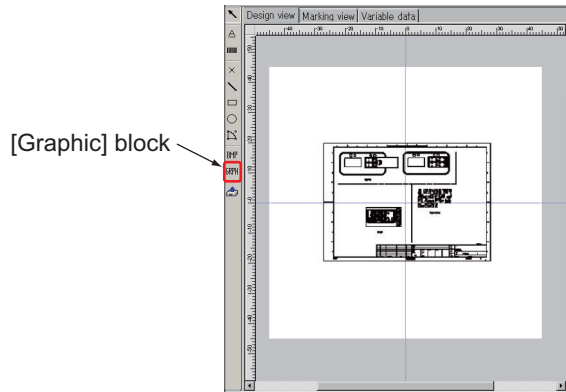

Marks a graphic file (DXF format).

The marking content can be changed using the variable data table and the date/time variable data table.



Reference

- "5.4 Variable Data Table Setting Function (page 5-17)"
- "5.5 Date/Time Variable Data Table Setting Function (page 5-30)"

Part File

A part file that was registered in advance can be loaded to be used when creating marking data.

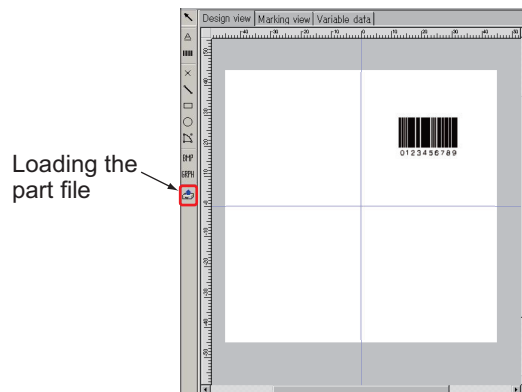

Multiple blocks can be registered to a single part file, and can be placed all at once when marking data is being created.



Reference

- "5.2 Part File Registration Function (page 5-12)"

Reference Folder Settings

When data is shared via Ethernet communication, the save location of the marking data can be set to the laser marker unit or to any folder on a device connected on the network.

■ Save folder

The laser marker data save folders have the following configuration.

When you specify the directory to create the save folder in, the data folders are automatically created below the “Data” folder in the figure below.

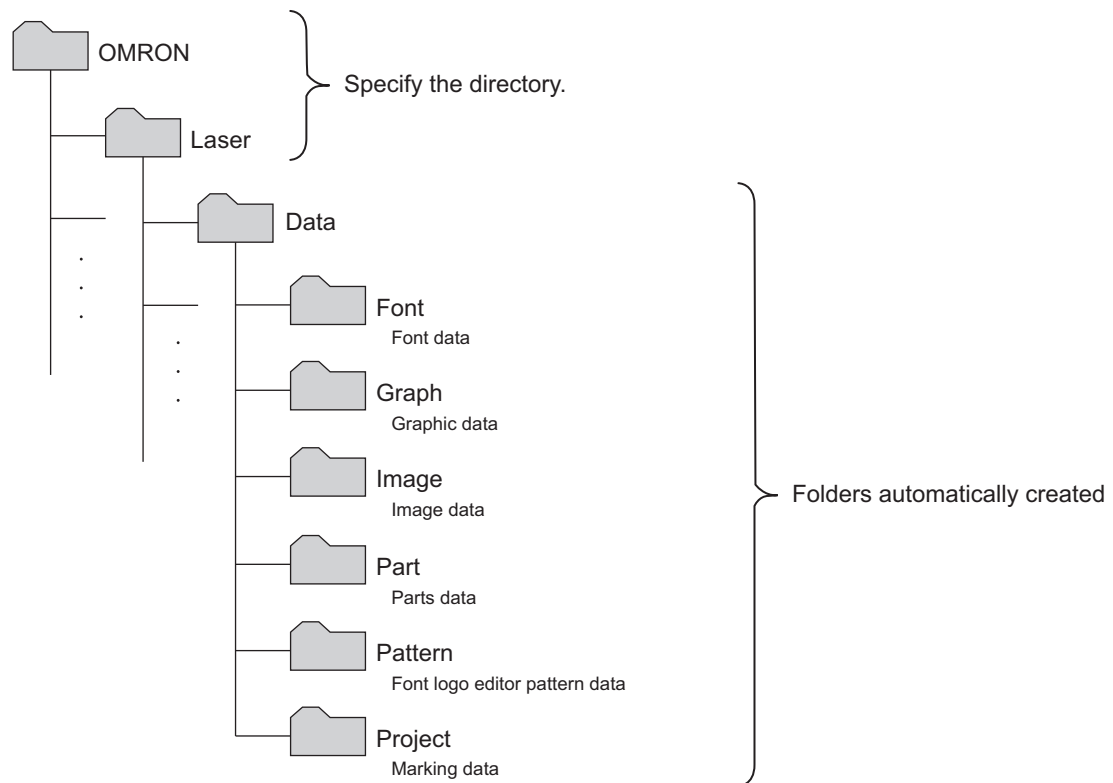

If the “Data” folder already exists in the specified directory and some of the folders are missing, the missing folders are created when the directory is specified.

■ Shared files and device-specific files

Data files that can be saved in shared folders can also be shared between devices. Device-specific files are saved in the laser marker unit.

The breakdown of shared files and device-specific files is as follows.

● Shared files

File name	Format
Marking data	***.lmp
Variable data	VariableStringData ***.xml
Date/time variable data	DataTimeData ***.xml
Stroke font	***.osf
Graphic data	***.olg, ***.dxf
Image data	***.bmp
Parts data	***.osp
Pattern data	***.ptn

● Device-specific files

File name	Format
Device settings (position correction values, environmental setting values)	LM.ini
Project counter data	ProjectCounters***.txt
System counter data	SystemCounters.txt
TrueType font	***.ttc, ***.tff
Files related to controller operations (operation logs etc.)	-

■ How to specify reference folder

- 1 Click [Environment setting] on the menu bar, and then select [Ref. folder set].

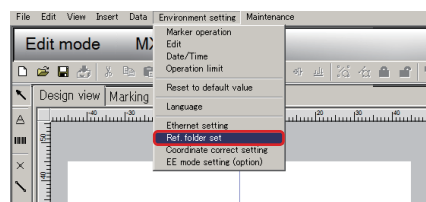

The [Ref. folder set] dialog box is displayed.

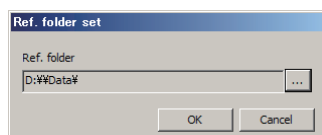

2 Click [...].

1

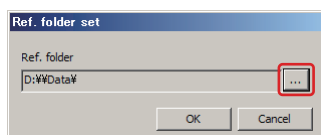

[Ref. folder set] dialog box is displayed.

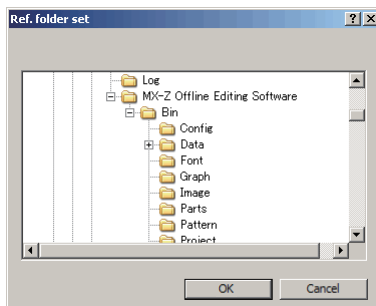
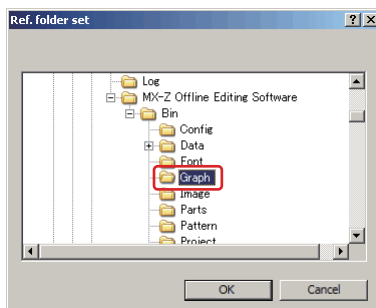
**3 Specify the folder, and then click [OK].**

Chapter 2

Creating Marking Data

Creates and saves the marking data on the [Edit mode] screen.

2.1	Flow of Creating Marking Data.....	2-2
2.2	Coordinate.....	2-3
2.3	Screen Configuration	2-7
2.4	Block Operation.....	2-9
2.5	Preparation for Creating Marking Data	2-12
2.6	Block Setting	2-14
2.7	Common Setting	2-108
2.8	Pallet Setting	2-125
2.9	Saving the Marking Data.....	2-134

2.1 Flow of Creating Marking Data

The flow of creating marking data is as shown in the figure below.

After setting the block and common settings in the [Edit mode] screen, and creating the marking data, confirm the optimum marking conditions through test marking.

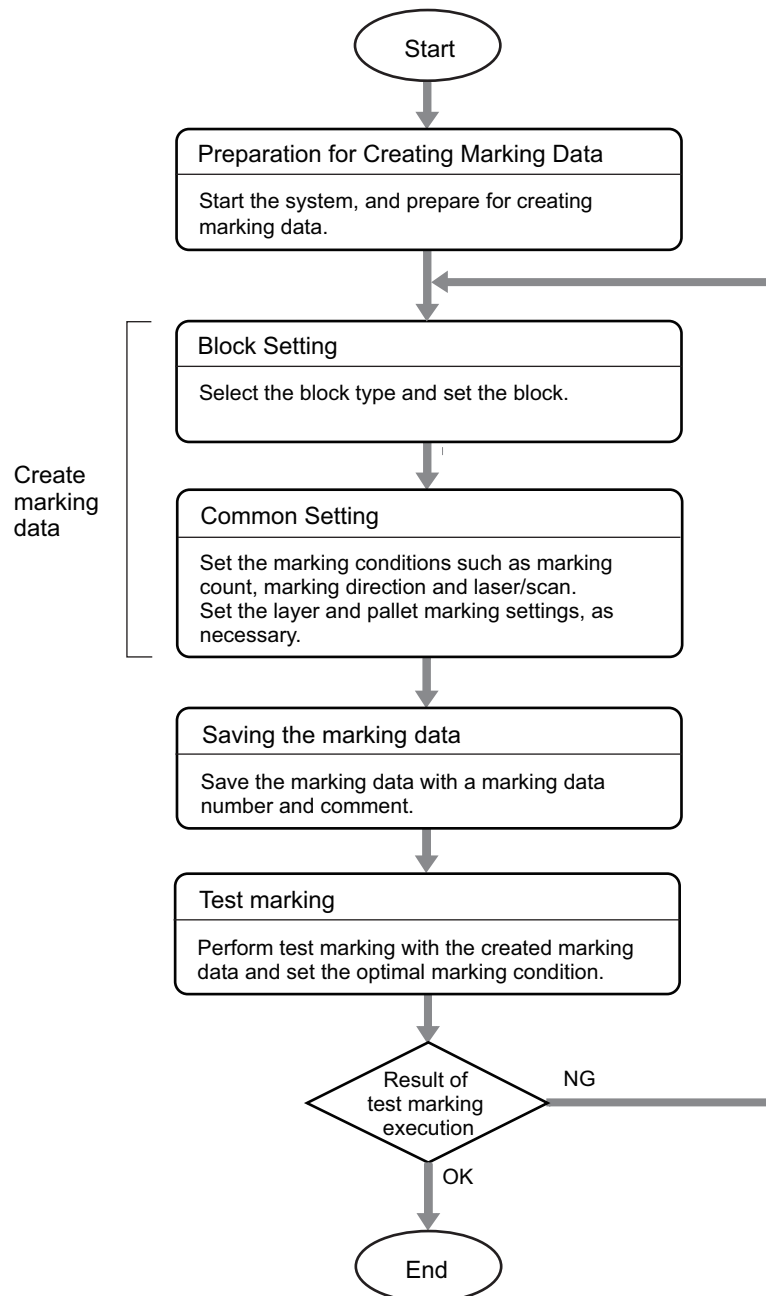

2.2 Coordinate

This section explains the concept of “coordinates,” which are required when operating the marker software.

Coordinate

With the marker software, the position of the block to be set as marking data and the position and rotating angle to make corrections are expressed in coordinates and direction as illustrated in the figure below.

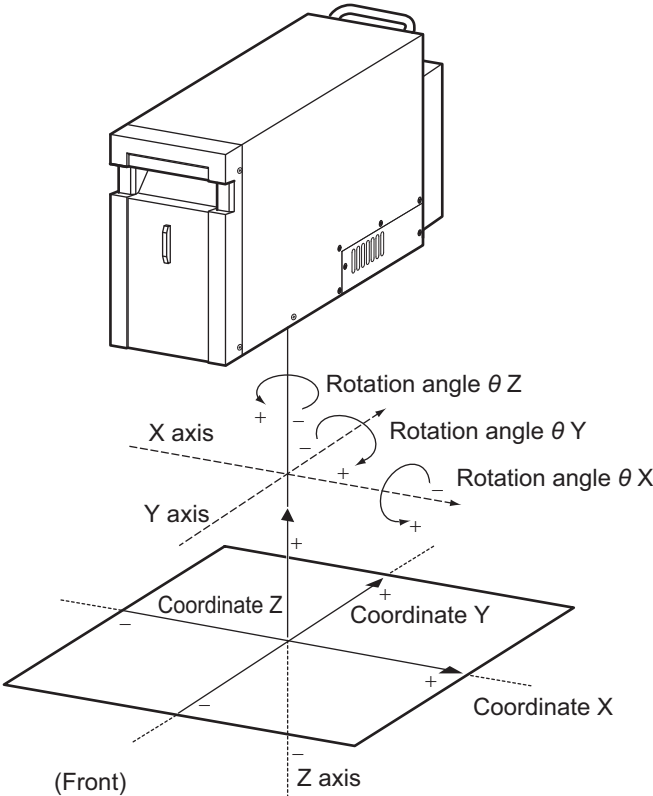

(Example) Rotation direction and tilt with a setting of $\theta X = +$ direction, and $\theta Y = +$ direction

With a setting of $\theta X = +$ direction

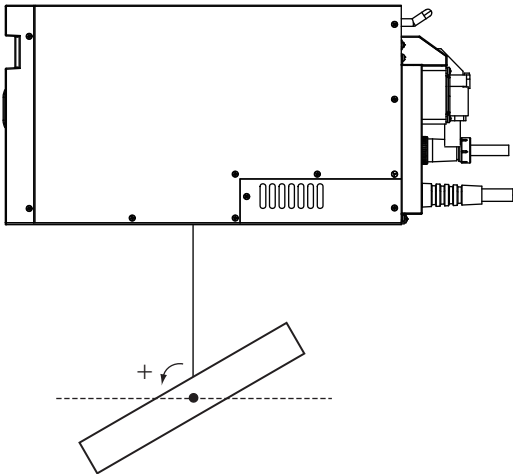

With a setting of $\theta Y = +$ direction

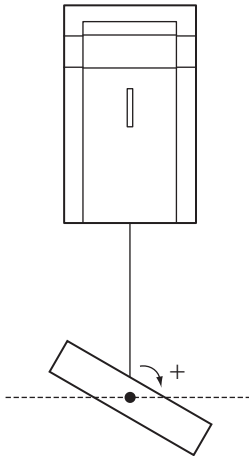

- **Coordinate X**

X direction (horizontal/lateral) coordinate

- **Coordinate Y**

Y direction (horizontal/vertical) coordinate

- **Coordinate Z**

Z direction (perpendicular) coordinate

- **Rotation angle θX**

Rotation angle with X-axis at the center

- **Rotation angle θY**

Rotation angle with Y-axis at the center

- **Rotation angle θZ**

Rotation angle with Z-axis at the center

Handling of Coordinate in Marker Software

The block position on the sheet when using the marker software is expressed as a distance (unit: mm) from the center of the sheet (coordinate X =0/coordinate Y = 0). The values range as follows: Coordinate X = MX-Z2000H-V1 -45 to 45, MX-Z2050H-V1/Z2055H-V1 -80 to 80 / Coordinate Y= MX-Z2000H-V1 -45 to 45, MX-Z2050H-V1/Z2055H-V1 -80 to 80.

A "reference point" (red/green dot display) is provided for each block, and the block position is expressed as coordinate X/coordinate Y of this reference point. If a block is moved, the [Coordinate X]/[Coordinate Y] values in the setting area will change accordingly.

Note that the reference point position varies by blocks.

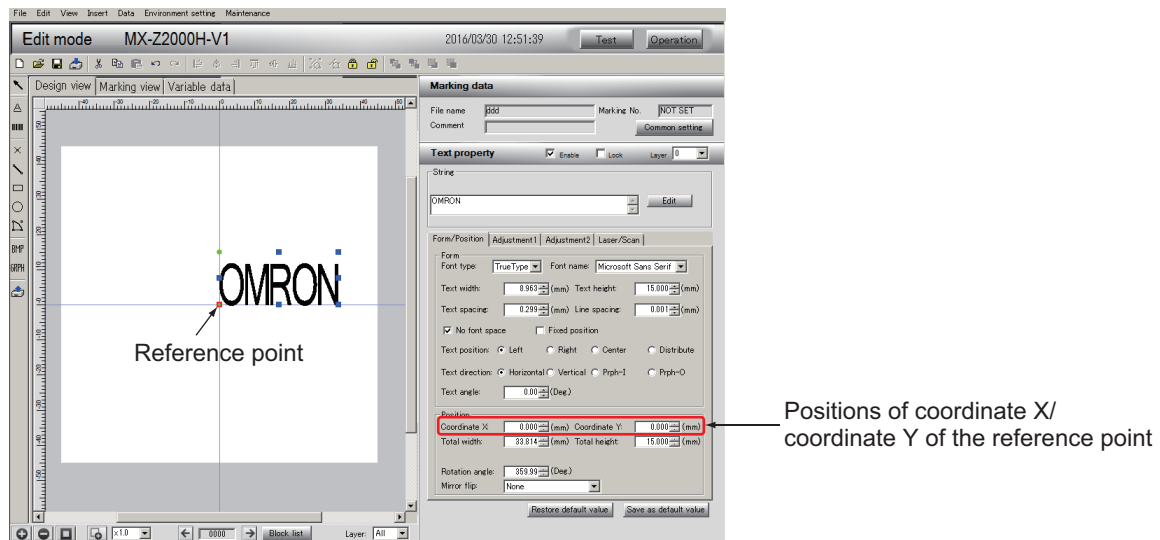

Position Correction

The laser position must be corrected before starting marking in order to set the appropriate focus distance and marking position for the work.

Correct the position by selecting [Position correction] in [Maintenance] on the menu bar of the [Edit mode] screen.

Reference

For details on position correction, refer to:

- "7.1 Position Correction (page 7-2)"
- "Fiber Laser Marker MX-Z2000H-V1 series Setup Manual" (Z415)

Marking Direction

The marking direction varies depending on the direction in which the work flows relative to the laser. Accordingly, the marking direction that matches the work direction must be set before marking is started. Set the marking direction by selecting [Marking direction] in [Common setting] on the [Edit mode] screen.

Reference

- "♦ Marking direction setting (page 2-109)"

Marking Area

Create the block so that it is inside of the marking area.

The block will be displayed in red if even only a small portion of it is outside of the marking area.

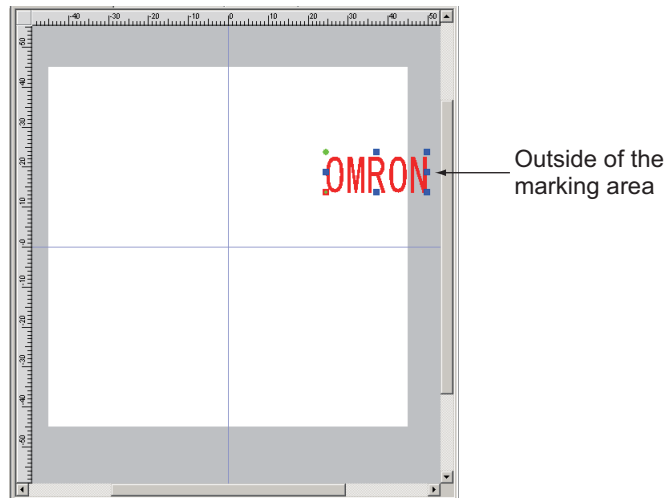

2.3 Screen Configuration

The configuration of the [Edit mode] screen is explained using the screen of MX-Z2000H-V1 as an example.

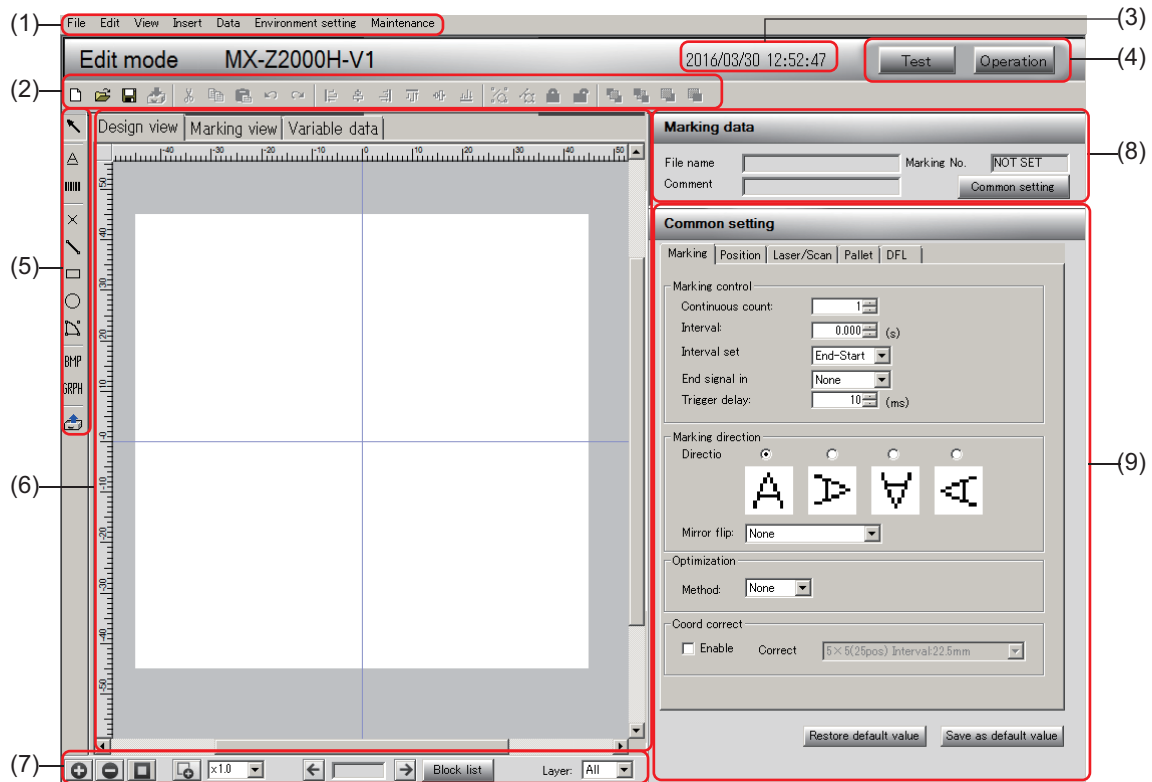

(1) Menu bar

This is the marker software function menu.

(2) Tool bar

These tools are used to operate the marking data files, and to create/edit blocks. The functions that are frequently used from the menu are provided as buttons.

Reference

- "A.1 Specifications of Menu Bar and Toolbar (page A-2)"

(3) Current date/time

The current date and time are displayed.

(4) Screen mode selection area

When performing actual marking, click [Operation]. The screen switches to the operation mode. When performing test marking, click [Test]. [Test marking] dialog box is displayed.

(5) Block menu

Selects the type of block to be created.

(6) Sheet

This is the area where a block is created/edited and actual marking can be previewed.

(7) View setting, block/layer switching area

Uses these tools to enlarge/shrink the sheet or switch between blocks and layers.

(8) Marking data information display area

The file name, marking data number, and comment for the marking data that is currently open are displayed.

(9) Marking setting area

If a block is selected, the block setting items (property) are displayed.

If a block is not selected or when you clicked [Common setting] in the “(8) Marking data information display area”, [Common setting] is displayed.

2.4 Block Operation

This section explains the basic operations of the block on a sheet.

Handle

In addition to the “reference point,” an operation point called “handle” (blue or green dot) is also provided for the block that is displayed in the view area.
Place the mouse cursor on the handle and drag it to rotate the block or enlarge/shrink it.

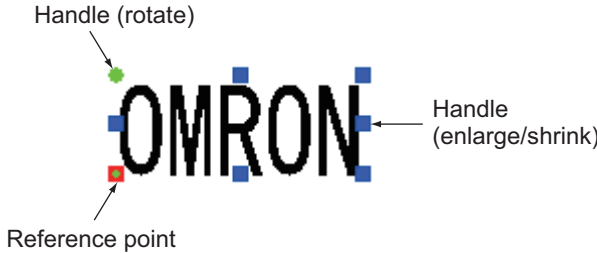

Operation with Mouse

Although the position and size of the block data on the sheet are to be set on the “Marking setting area”, the following operations can also be performed with the mouse.

■ Moving the block

Select the block, and drag it to a desired position.

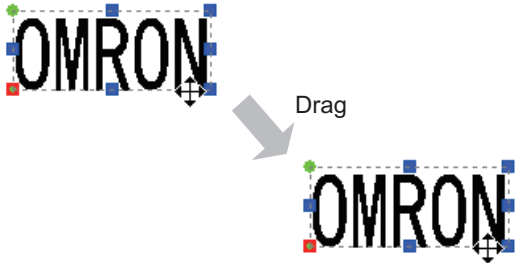

■ Rotating the block

Place the mouse cursor on the handle (green) in the upper-left area of the block frame, and drag it in the rotation direction (left).
In this case, the reference point is the rotation axis.



■ Enlarging/shrinking the block

Drag the handle (blue) in the block frame.

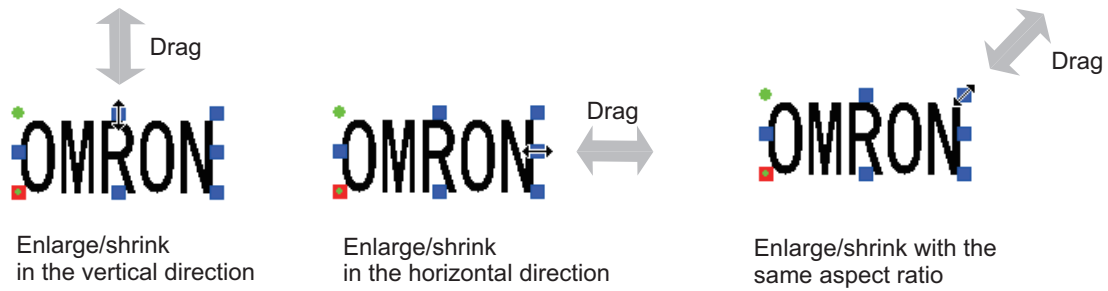

Switching the Selected Block

When there are multiple blocks on the sheet, you can switch the selected block.

When you click [←]/[→] in the view setting or block/layer switching area, the block number data displayed in the text box will be selected.

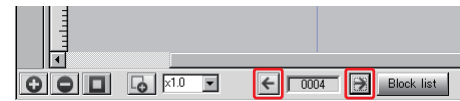

Grouping the Blocks

When there are multiple blocks on the sheet, they can be grouped into a group of blocks.

Specify a range by dragging the mouse or left-clicking the blocks while holding the [Ctrl] key on the keyboard to select the blocks to be grouped, and click [Edit] on the menu bar and select [Group] - [Group].

To ungroup, specify the group of blocks, and select [Ungroup].

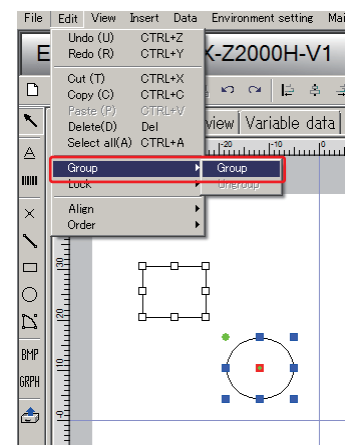

■ Group property

Group of blocks are treated as 1 block on the sheet. When group of blocks are selected, however, only the position can be set in [Group property].

Group property Enable Lock Layer

Position

Coordinate X: (mm) Coordinate Y: (mm)

Width: (mm) Height: (mm)

Rotation angle: (Deg.)

2



Precautions for Correct Use

When a block that has been rotated (handle of the group of blocks is displayed in light blue) is included in the group of blocks, that group of blocks cannot be resized. In this case, group the blocks after rotating and resizing the blocks individually.

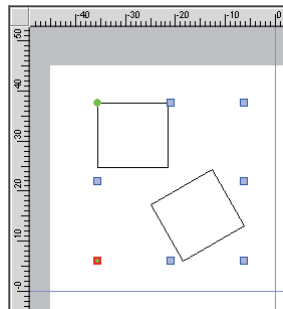

2.5 Preparation for Creating Marking Data

Turn ON the system power supply to start the marker software, and prepare for creating marking data.

Creating New Marking Data

Create new marking data.

- 1 Click **[File]** on the menu bar, and then select **[New]** (or click  on the toolbar).
A new file is opened and new marking data can now be created.

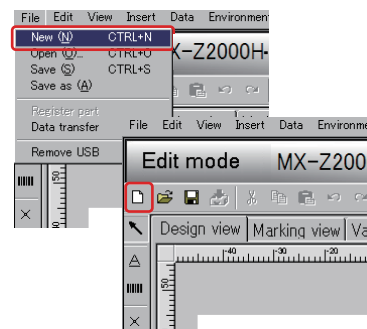

Editing the Marking Data

Edit the content of existing marking data.

- 1 Click **[File]** on the menu bar, and then select **[Open]** (or click  on the toolbar).
The [Select marking data] dialog box is displayed.

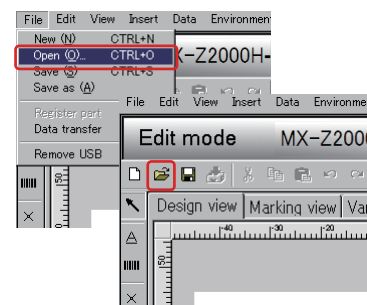

- 2 Select the marking data and click **[Open]**.
The selected marking data is displayed.

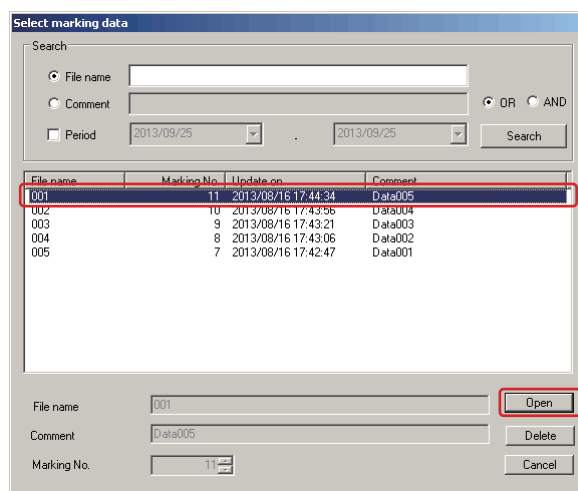



Additional Information

- With the [Select marking data] dialog box, you can search marking data with the method described below.
 - Search with file name
 - Search with comments saved with the marking data
 - Search with the date (period) of creation
 - Search with file name and the date (period) of creation
 - Search with comments and the date (period) of creation

You cannot select both [File name] and [Comment] as a search keyword at the same time.

In the [Search] box, select the item that you want to use for the search from above, enter the search keyword and/or period, and then click [search].

You can specify OR and AND conditions. When specifying multiple search keywords, separate the keywords with a comma “,” or semicolon “;”.

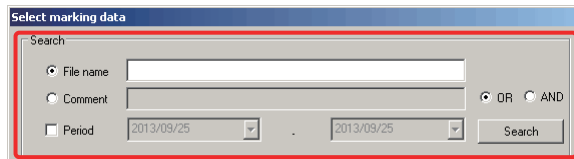

- If you perform these operations without saving the marking data being created, a message confirming unsaved data will be displayed. To save the data, click [No] and save the data. Click [Yes] to create new marking data or open another marking data without saving it. In this case, the marking data being created will be deleted.

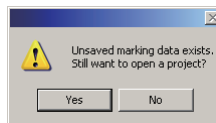

2.6 Block Setting

The method of setting the marking data blocks individually is explained.

[Text] Block

The procedure for setting a [Text] block is explained using the following as an example.

■ Setting

Mark string “MX-Z2000” on the upper level of the work, and the Year/Month/Day, as well as a 4-digit counter on the lower level of the work.

Create the string “MX-Z2000” block and the Year/Month/Day and counter block individually.

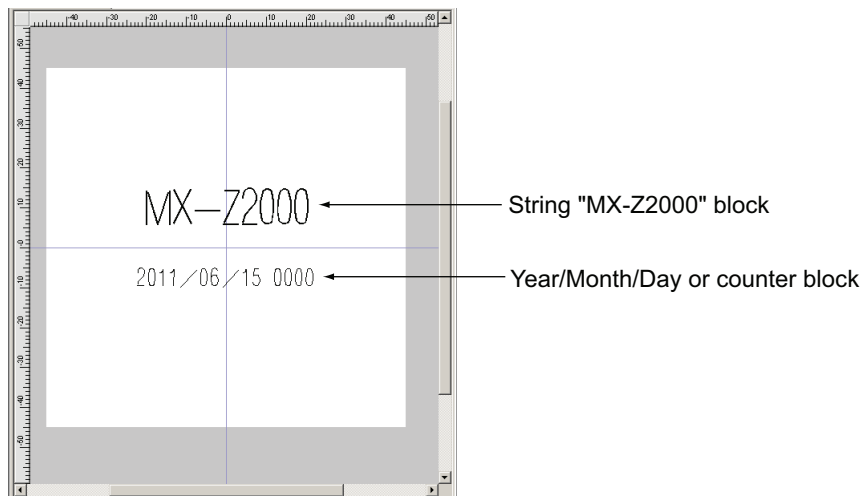

■ Setting procedure

● Creating string “MX-Z2000” block

- 1 Click  on the block menu, or click [Insert] on the menu bar and then select [Text]. [Text property] is displayed.

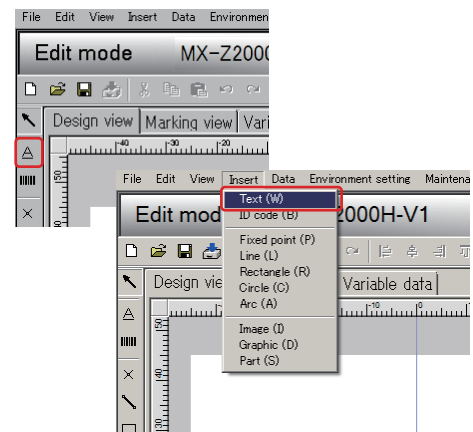

- 2 In the [String] text box, enter the string "MX-Z2000" to be marked.

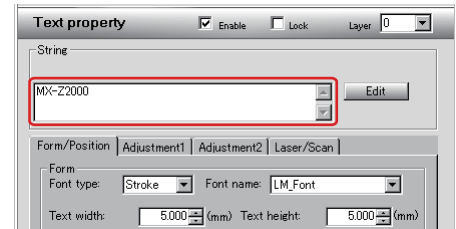

2

String, "MX-Z2000," will be displayed on the sheet as a block.

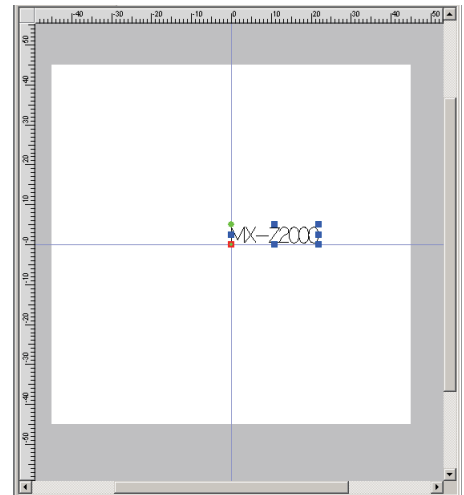

Additional Information

- Up to 512 characters can be entered in the [Text] block.
- Single-byte katakana cannot be used in the [Text] block.

- 3 Select the [Form/Position] tab and set the following items.

<Form>

- Font type/Font name : Stroke/original 2
- Text width/Text height : 10 mm/10 mm
- Text spacing : 1mm
- No font space : Enable
- Text direction : Horizontal

<Position>

- Coordinate X/Coordinate Y : -20 mm/5 mm

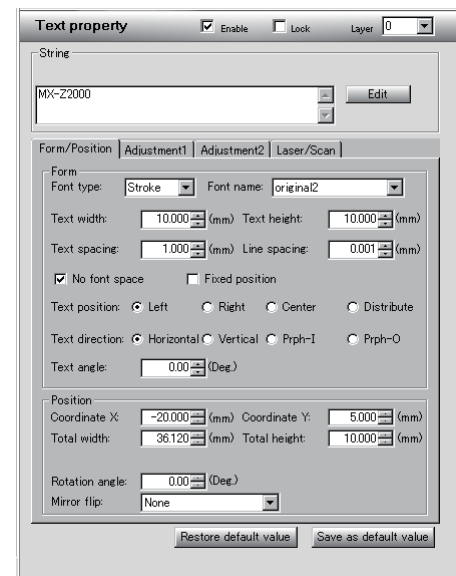

Additional Information

Extended fonts can be created and existing fonts can be edited using the Font logo editor. (Refer to "Chapter 11 How to Use Font Logo Editor (page 11-1)")

4 Select the [Adjustment1] tab and set the following items.

<Bold>

- Bold : Enable
- Count/Width : 10/0.2 mm

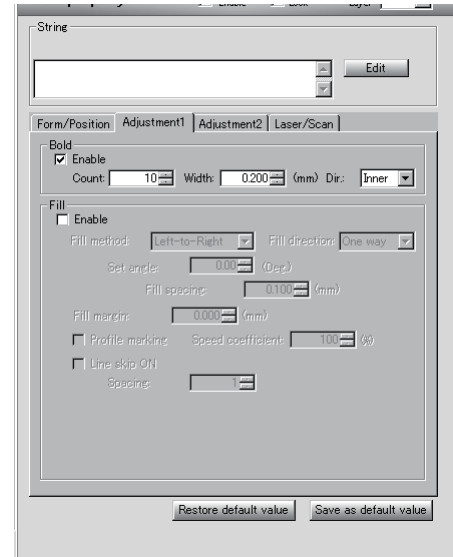

5 Click a blank area outside of the block on the sheet to confirm in the block.

● Creating a Date/Time or counter block

- 1 Click  on the block menu, or click [Insert] on the menu bar and then select [Text].
[Text property] is displayed.

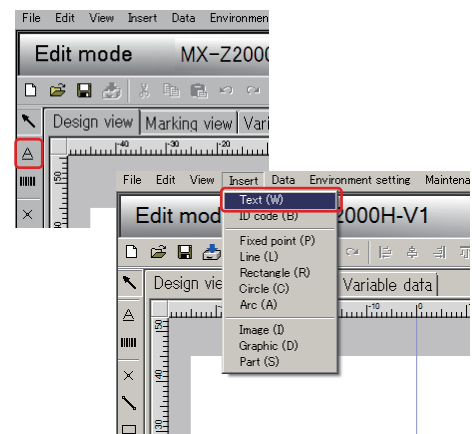

- 2 Click [Edit].
The [Edit] dialog box is displayed.

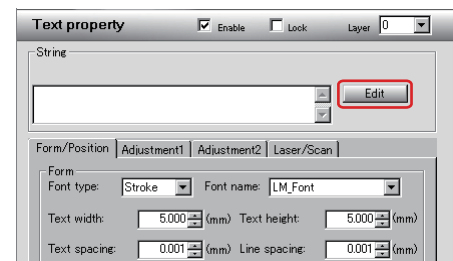

3 After selecting “Year (AD)” in [Date/Time] under the Date time table tab, set the following and click [Add].

- Align text : Shift to left
- No zero suppression : Enable
- Digit : 4 digits

The date and time display code, “%4Y01%,” will be displayed in [Content].

4 After selecting “Month” in [Date/Time], set the following and click [Add].

- Align text : Shift to left
- No zero suppression : Enable
- Digit : 2 digits

The date and time display code, “%2M01%,” will be displayed additionally in [Content].

5 After selecting “Day” in [Date/Time], set the following and click [Add].

- Align text : Shift to left
- No zero suppression : Enable
- Digit : 2 digits

The date and time display code, “%2D01%,” will be displayed additionally in [Content].

6 Select the [Counter] tab and click [Counter setting].

The [Counter setting] dialog box is displayed.

7 With “0” displayed in [Counter No.], select the [Enable counter] check box and set the following, and then click [OK].

- Initial value/End value : 0/9999
- Step : 1
- Initial timing : Change marking data
- Count timing : Marking
- Count end action : Error stop
- Count end output : None
- Output type : Pulse

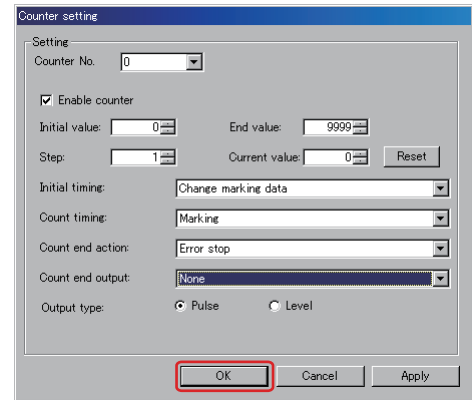

8 In the [Counter] tab, set the following and click [Add].

- Counter No. : 0
- Align text : Shift to left
- No zero suppression : Enable
- Digit : 4 digits
- Base : 10

The counter display code, “%4C001001%,” will be displayed additionally in [Content].

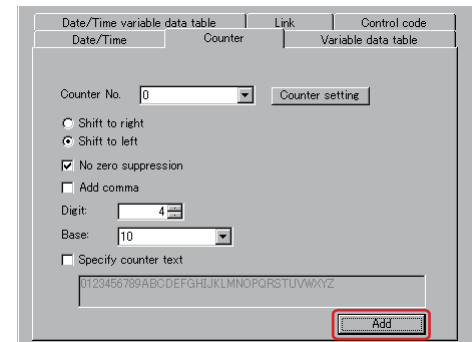

9 Click [OK].

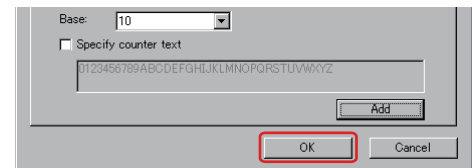

The specified date and time and counter will be displayed as blocks on the sheet.

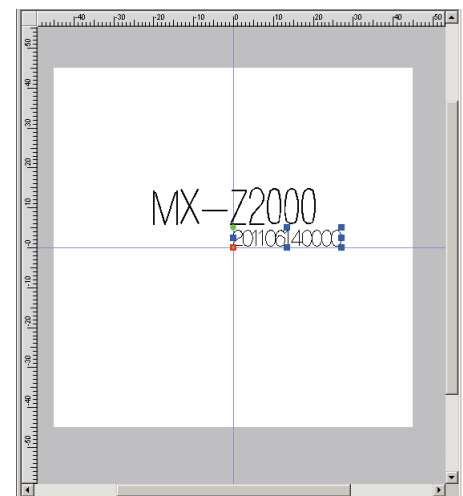

10 Select the [Form/Position] tab and set the following items.

<Form>

- Font type/Font name : Stroke/original 2
- Text width/Text height : 5 mm/5 mm
- Text spacing : 1 mm
- No font space : Enable
- Text direction : Horizontal

<Position>

- Coordinate X/Coordinate Y : -22 mm/-10 mm

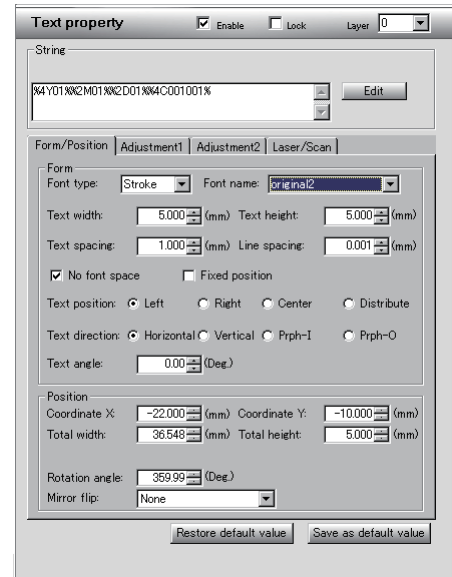

11 Insert a delimiter, “/,” between the date and time display code of “Year (AD)”/“Month”/“Day.”

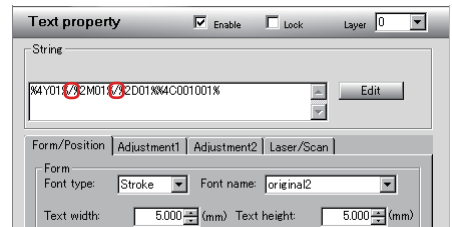

12 Insert a space as a delimiter between the date and time display code and the counter display code.

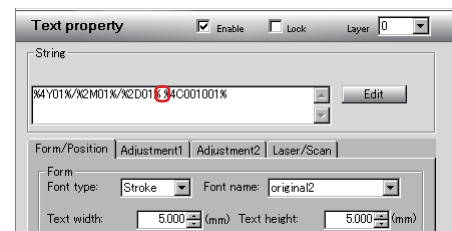

13 Click a blank area outside of the block on the sheet to confirm in the block.

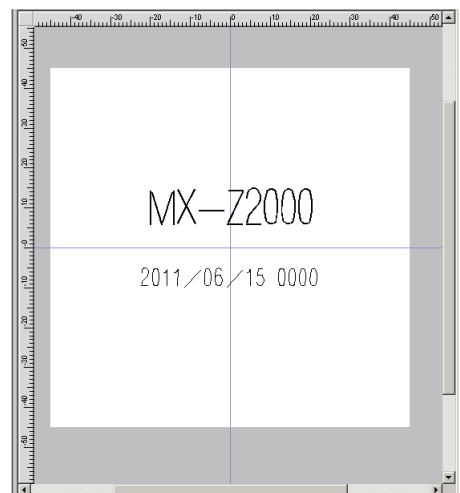

Reference

For the display code additionally displayed in [Content] depending on the settings, refer to:

- "A.6 List of Display Codes (page A-23)"

■ [Text property] setting items

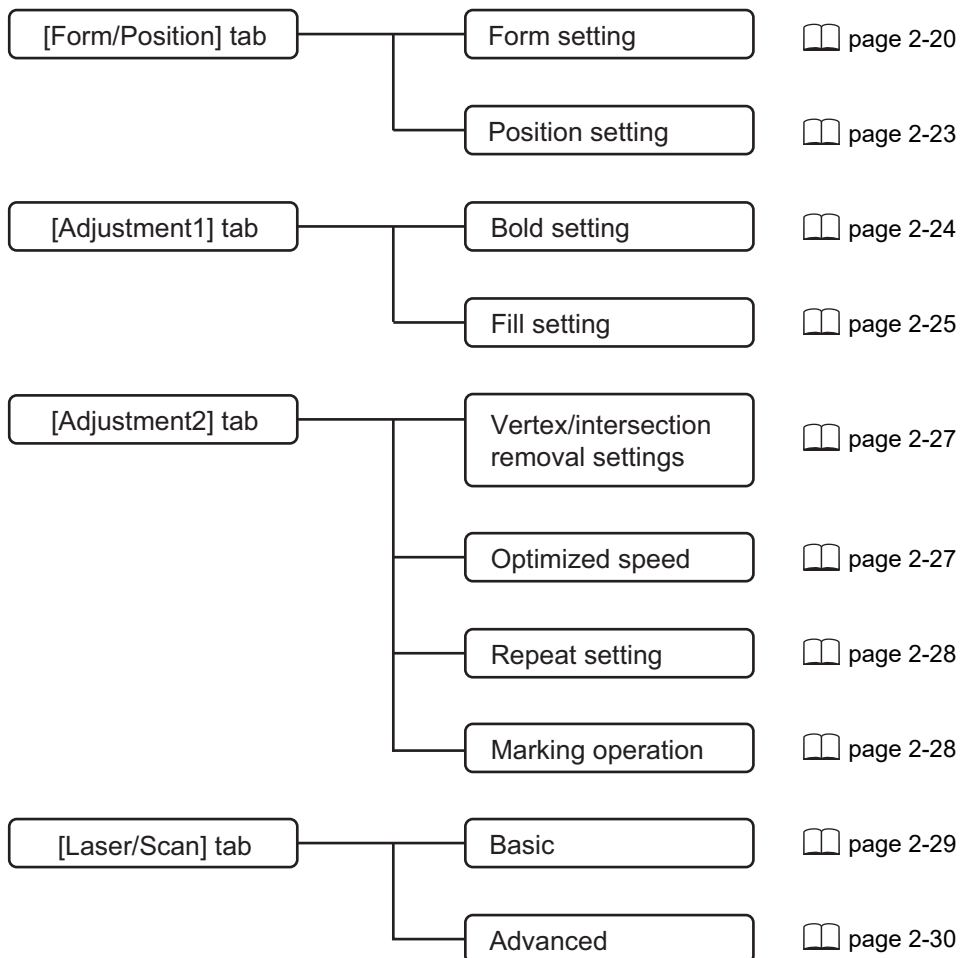

● [Form/Position] tab

◆ Form setting

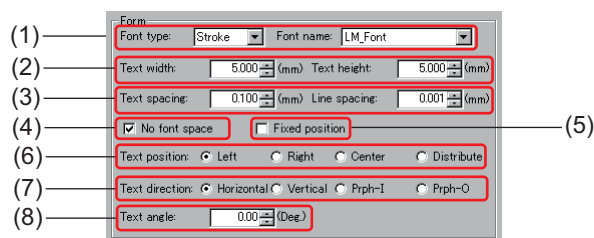

(1) Font

Specifies the type of font to be used in [Font type] and the font to be used in [Font name]. This system only supports “True Type fonts” or “Stroke fonts.”

- True Type fonts: The border of the text is converted into data by the positional information of the straight lines and curves, and by mathematical formula. The border lines of the text are smoothed out.
- Stroke fonts: Text is retained as information consisting of, not borders, but only lines. Text is drawn using the center line.

• TrueType font



• Stroke font



Additional Information

Extended fonts can be created and existing fonts can be edited using the Font logo editor. (Refer to "How to Use Font Logo Editor (page 11-1)")

(2) Text width/Text height

Sets the width of one character under [Text width], and the text height under [Text height].

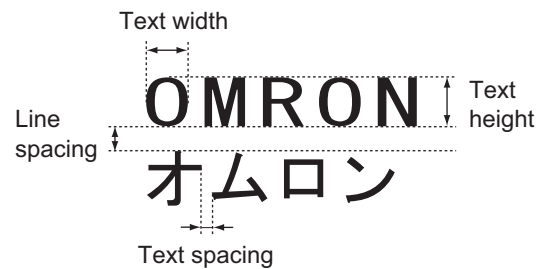

Additional Information

To place a string using a font of an equal-width set in [Text width], set [Font type] in "(1) Font" to "Stroke," and clear the "(4) No font space" check box. If a True Type font is specified, or when the Stroke font is specified, but the "(4) No font space" check box is selected, each text width is adjusted by the text width specific to the font.

(3) Text spacing/Line spacing

Sets the pitch between adjacent characters in [Text spacing]. If the strings are in multiple lines, sets the line space between strings in [Line spacing].

(4) No font space

The setting changes as follows between when the check box is selected and when cleared.

Both True Type fonts and Stroke fonts are placed upon being adjusted by the text width specific to the font (the blank space to the left or right of the font are removed).

- True Type font

Fonts are placed upon being adjusted by the text width specific to the font (including the space to the left or right of the font).

- Stroke font

The font is placed at an equal-width of the value specified in "(2) Text Width."

<No font space (the checkbox is selected)>

- TrueType font



- Stroke font



- TrueType font



- Stroke font



Additional Information

In all of the above cases, the pitch set in "(3) Text spacing" is applied.

(5) Fixed position

When this check box is selected, the string width or height does not change and its original condition is maintained even if the text frame width or height are changed.

When this is cleared, if the text frame width or height is changed, the string width or height changes relative to the change in the frame.

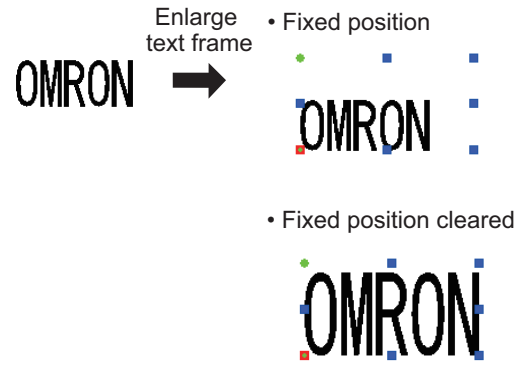

(6) Text position

This is set to mark strings in multiple lines.



(7) Text direction

Sets the direction of the text.

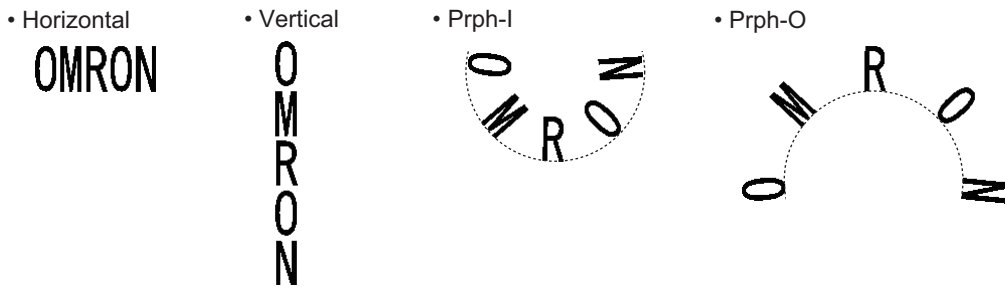

(8) Text angle

Sets the tilt angle of the text.

The text is tilted to the left at the specified angle with the lower-left area of the block as the reference point.



◆ **Position setting**

The setting items vary depending on the text direction set in the previous item, “(7) Text direction.”

<Text direction: Vertical/Horizontal>

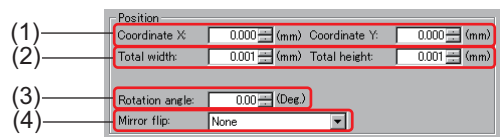

(1) Coordinate X/Coordinate Y

Sets reference point coordinate X and coordinate Y.

(2) Total width/Total height

Sets the width and the height of the entire block.

(3) Rotation angle

Sets the rotation angle of the entire block against the X-axis.

The text is rotated to the left at the specified angle with the lower-left area of the block as the reference point.

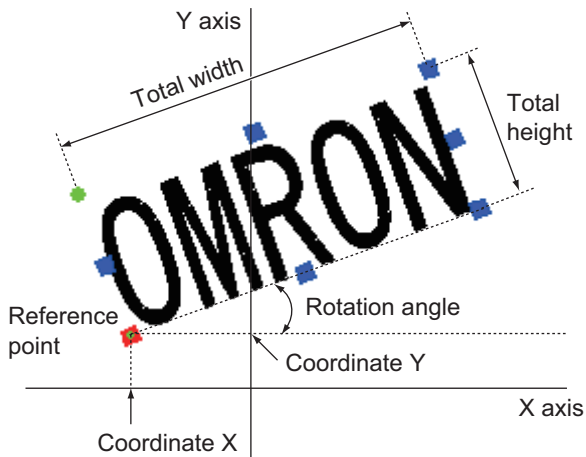

(4) Mirror flip

This is set to flip a string.

(Example) Horizontal

- Left/Right



- Up/Down



- Up/Down/Left/Right



<Text direction: Prph-I/Prph-O>

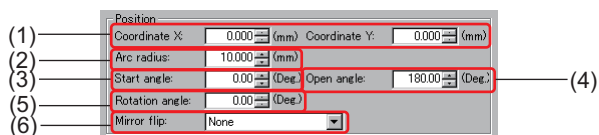

(1) Coordinate X/Coordinate Y

Sets reference point coordinate X and coordinate Y.

(2) Arc radius

Sets the arc radius.

(3) Start angle

Sets the start angle of the string.

(4) Open angle

Sets the open angle of the string.

Example: Inner circle

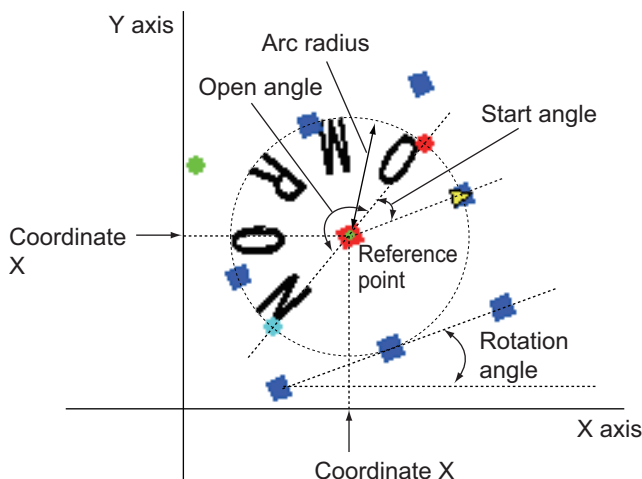

(5) Rotation angle

Sets the rotation angle of the string against the X-axis.

(6) Mirror flip

This is set to flip a string.

● [Adjustment1] tab

◆ Bold setting

Formats the text to bold.

Several lines are placed at equal intervals surrounding a single line to format the text to bold.

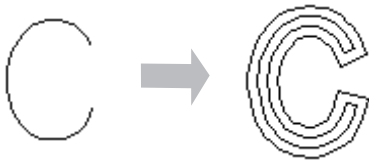
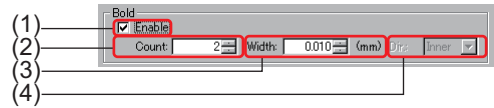

If a True Type font has been selected, the border of the text will be formatted to bold.

If a Stroke font is selected, the text itself will be formatted to bold.

(Example) Format the text "C" with the line width of 0.8 mm.

<TrueType font>

• Without formatting to bold



• Format to bold with 4 lines



• Format to bold with 10 lines



<Stroke font>

• Without formatting to bold



• Format to bold with 4 lines



• Format to bold with 10 lines



Additional Information

If the bold setting is applied, the next paragraph, "Fill setting," will be disabled.

(1) Enable

This check box is selected to enable bold formatting of text.

When this is cleared, the text is displayed in a single line.

(2) Count

Sets how many lines are to be used to format the text to bold.

(3) Width

Sets the bold line width (the distance between the outermost lines).

**Additional Information**

With the line width set to "0," round-trip marking can be repeated the number of times specified in "(2) Count."

(4) Dir.

Set the marking start position when formatting the text to bold (setting the "(2) Count" to 3 or more).

- Inner: Marking is started from the inside of the text.
- Outer: Marking is started from the outside of the text.

◆ Fill setting

Sets the fill method when filling the text. This setting is enabled only for True Type fonts.

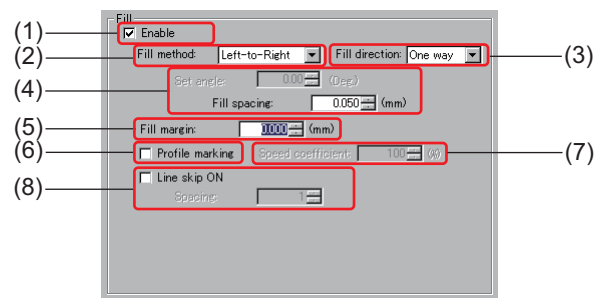
**Additional Information**

When the fill setting is selected, the previous item, "Bold setting," will be disabled.

(1) Enable

This check box is selected to enable the text fill setting.

(2) Fill method

Selects one of the following as the fill method.

Item	Description
Left-to-Right	Fills in the lateral direction from left to right at the fill spacing set in "(4) Set angle/Fill spacing."
Right-to-Left	Fills in the lateral direction from right to left at the fill spacing set in "(4) Set angle/Fill spacing."
Top-to-Bottom	Fills in the vertical direction from bottom to top at the fill spacing set in "(4) Set angle/Fill spacing."
Bottom-to-Top	Fills in the vertical direction from top to bottom at the fill spacing set in "(4) Set angle/Fill spacing."
Set	Fills at the fill angle and spacing set in "(4) Set angle/Fill spacing."

(3) Fill direction

Sets either of the following:

- Round trip: Fills both directions.
- One way: Fills one direction.

"Round trip" is selected to shorten the marking time.

(4) Set angle/Fill spacing

When “Set” is selected in “(2) Fill method,” sets the angle in [Set angle], and the spacing between fill lines in [Fill spacing].

When “Left-to-Right”, “Right-to-Left”, “Top-to-Bottom”, or “Bottom-to-Top” is selected in “(2) Fill method,” set the spacing between fill lines in [Fill spacing].

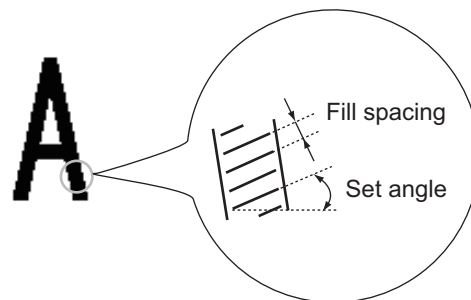

(5) Fill margin

Sets the spacing (margin) between the text border and the fill lines.

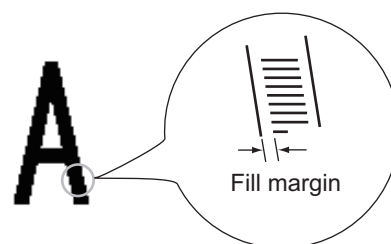

(6) Profile marking

This check box is selected to mark the string borders when filling.

(7) Speed coefficient

The speed to mark the border can be set individually.

The speed is calculated by multiplying the processing speed or the moving speed by a coefficient.



Additional Information

When the processing speed exceeds 12000 mm/s due to the set speed coefficient, the border is marked at 12000 mm/s.

(8) Line skip ON/Spacing

This check box is selected to enable line skip for fill (skipping every few lines to avoid heat effects) and to set the spacing between the lines (at every how many line the text should be filled).

Set the Line skip to 1

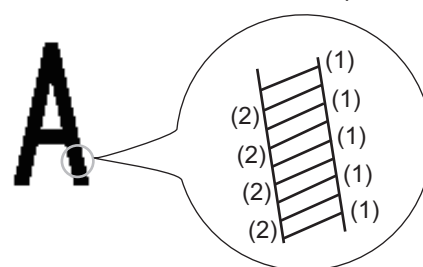

After the marking of (1) is finished, start the marking of (2).

● [Adjustment2] tab

◆ Vertex/intersection removal settings

Marking is performed so that the lines do not overlap one another at a vertex or intersection (where lines cross one another) of the text in order to prevent deep carving or burning. This is set taking work materials, etc. into account.

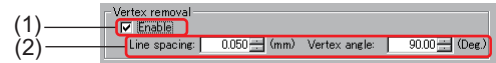

(1) Enable

This check box is selected to enable vertex/intersection removal.

(2) Line spacing/Vertex angle

Sets the line spacing and the angle at which the vertex is determined when performing vertex/intersection removal.

- Line spacing: Remove other lines that are in the area specified in Line spacing (removal area).
- Vertex angle: Set the angle at which the vertex is determined when performing vertex removal.
The vertex is removed when the vertex angle is smaller than the value set here.

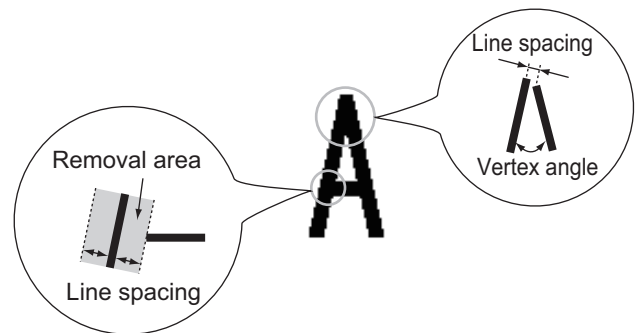

Precautions for Correct Use

Take note of the line spacing setting when using intersection removal and bold formatting together. The lines that are added when formatting the text to bold may be removed if the line spacing is set too wide. (Refer to "◆ Bold setting (page 2-24)")

◆ Optimized speed

This check box is selected to increase the marking speed.

When marking is optimized, the system automatically adjusts the string marking order within a block in order to finish the marking in the shortest amount of time.

When this is cleared, the string is marked in the original order set in advance on the system.



(1) Enable

This check box is selected to enable optimization of the marking speed.

Precautions for Correct Use

When the optimized speed is enabled, the bold setting and fill setting may be disabled depending on the condition.

◆ Repeat setting

This is set to mark the same string repeatedly when the marking is too light, etc.

(1)



(1) Repeat count

Sets the marking repeat count.

This is set to "0" to repeat the operation infinitely.

◆ Curve surface correction

This sets automatic correction for marking on curved surfaces, such as columns.

(1)

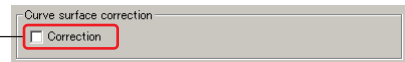

(1) Correction

This check box is selected when correcting curved surfaces.



Precautions for Correct Use

Place the block for which curve surface correction is performed within the layer diagram. Otherwise, the correction may not be performed properly or the block may not be displayed.

◆ Marking operation

Sets parameter for the following marking operation items.

(1)

(2)



(1) Smoothing

Select this check box for high-precision control of the marking speed.

(2) G-DAC*

This check box is selected to perform high-speed controlled marking.

Select the G-DAC check box to enable high-speed control of the marking scanning mirror (galvano mirror).

To enable G-DAC, the smoothing setting must be enabled.

* G-DAC: Galvano-Dynamic Acceleration Control



Precautions for Correct Use

- When the G-DAC setting is enabled, the items below operate with the settings for each block.
 - Processing speed
 - Moving speed
 - ON delay
 - OFF delay

Note that these items do not operate with the settings above for [Common setting].

- When G-DAC is enabled, calculation time will be required according to the marking time. Note that screen operations and so on may be somewhat sluggish at this time.
-



Reference

For how to check the marking time, refer to:

- "5.8 Marking Time Calculation Function (page 5-49)"
-

● [Laser/Scan] tab

◆ Basic

Specifies the basic laser and scanning settings.

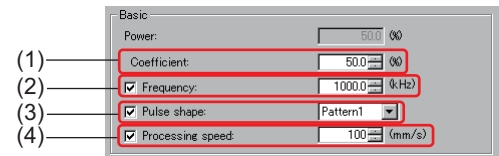

(1) Coefficient

Sets the laser power coefficient set in [Common setting].

The value of laser power specified in [Common setting] is multiplied with the coefficient set here, and the result is shown in [Power] at the top as the set value of the laser power for this block. The power will be limited at or below the 100kHz frequency due to the pulse shape.

📖 Reference

For details on coefficients, refer to:

- "■ [Laser/Scan] tab (page 2-115)"

Maximum laser power

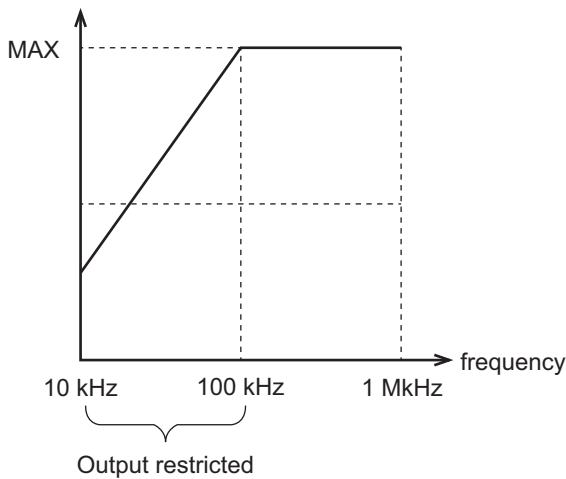

Laser power

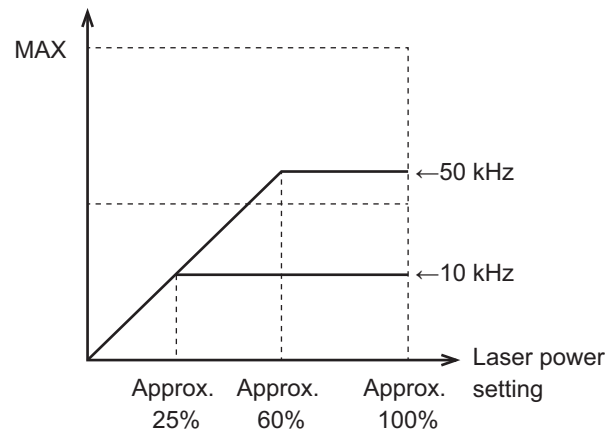

Graph showing restricted laser power when pulse pattern 1 is set

📄 Precautions for Correct Use

Laser power that is set too high may burn and damage the work depending on its material. Perform test marking and check the work condition when setting this value.

(2) Frequency

When setting the laser pulse frequency, the most appropriate frequency is set, taking the work material, etc. into account.

The frequency can be adjusted in the range between 10.0 and 1000.0 kHz in the standard mode, and in the range between 10.0 to 100.0 kHz in the EE mode.

📖 Reference

For details on how to switch between the standard mode and EE mode, refer to:

- "6.10 EE Mode Setting (page 6-24)"

(3) Pulse shape

Sets the pulse shape of the laser.

The pulse count fluctuates in the range between 7.5 and 300 ns from “Pattern 1” to “Pattern 15” in the standard mode, and in the range between 150 and 450 ns from “Pattern 1” to “Pattern 3” in the EE mode, and the heating time can be adjusted.

Sets the most appropriate pattern based on the work material and purpose.

The group of pulses specified in this pulse shape is emitted in the cycle specified in “(2) Frequency”.

- The laser pulse pattern and the actual number of pulses in the standard mode.

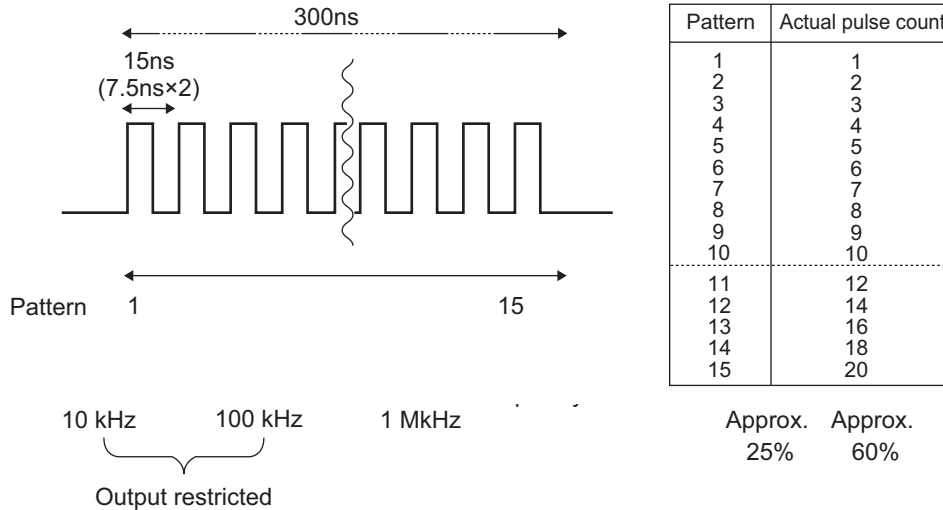

Graph showing restricted laser power when pulse pattern 1 is set



Reference

For details on how to switch between the standard mode and EE mode, refer to:

- "6.10 EE Mode Setting (page 6-24)"

(4) Processing speed

Sets the moving speed when the laser is continuously being emitted (when marking).

◆ Advanced

Specifies the advanced laser and scanning settings.

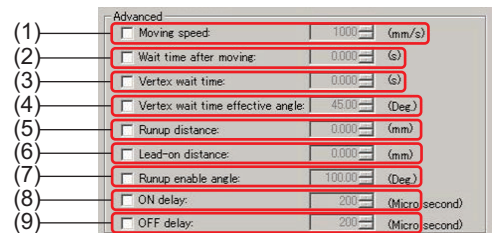

(1) Moving speed

Sets the moving speed when the laser is moving between characters or moving to a remote location.

(2) Wait time after moving

Sets the wait time until the next marking after the laser moved.

(3) Vertex wait time

Sets the wait time until the system starts to mark another line after finishing marking a line when marking a vertex.

(4) Vertex wait time effective angle

Sets the angle at which the vertex wait is enabled.

The vertex wait is enabled when the angle is smaller than the value set here.

(5) Runup distance

Sets the distance (runup distance) to start marking another line after finishing marking a line when marking a vertex.

(6) Lead-on distance

Sets the lead-on distance after the marking of a line is finished when marking a vertex.

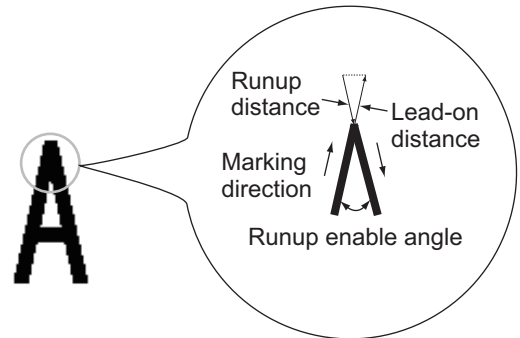
**Additional Information**

The longer the specified "(5) Runup distance" and "(6) Lead-on distance" are, the shaper the vertex angle will be. Note, however, that the marking speed will go down.

(7) Runup enable angle

Sets the angle at which the runup line is enabled.

The runup line is enabled when the angle is smaller than the value set here.

(8) ON delay

This is set to apply delay time after marking is started and until the laser is actually emitted.

(9) OFF delay

This is set to apply delay time after marking is completed and until the laser is actually emitted.

**Additional Information**

- The laser, runup line, and scanning settings are usually set through the [Laser/Scan] tab in the [Common setting] and used as the common settings for all marking data. (Refer to "2.7 Common Setting (page 2-108)"). Set individual settings through the [Laser/Scan] tab in the properties for each block individually when it is necessary to set values that are different from the common setting. Excluding [Coefficient] and [Power], any items that are checked will become effective as an individual setting for that block which is independent from the [Common setting].
- Click [Restore default value] to restore the default value. Furthermore, click [Save as default value] to save the settings on the screen as the default values. Note, however, that the above is not applicable to the [String] settings and the [Position] settings in the [Form/Position] tab.
- Click [Environment setting] on the menu bar, and then select [Reset to default value] to restore the factory default settings. (Refer to "6.5 Reset to default value (page 6-14)")

■ [Date/Time] tab setting items in the [Edit] dialog box

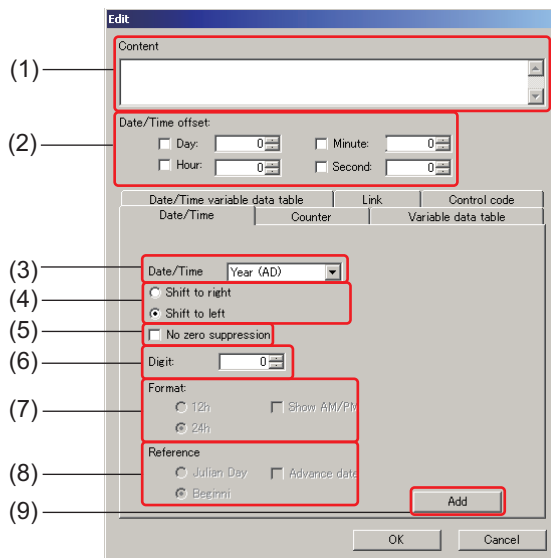

(1) Content

The setting is displayed with a date/time display code.

As necessary, delimiter characters/symbols (“Year,” “Month,” “/,” “.”, etc.) can be inserted for each item.

(2) Date/Time offset

A number of days and time are added to the current date/time for marking.

The check box for the item to offset (“Day,” “Hour,” “Minute,” and “Second”) is selected to set the number of days or time to be added.

The unit of each item applies.

If this is not set, the current date/time will be set.

Note that, when this is set, the setting will be additionally displayed in the “(1) Content” text box in the Date/Time offset display code.

(3) Date/Time

Sets the date and time type to be marked.

**Reference**

- "A.6 List of Display Codes (page A-23)"

**Precautions for Correct Use**

When date/time is set, the calculation time is affected depending on the marking data setting and screen operations may take longer than usual.

**Additional Information**

- When "Week" is set in [Date/Time], the week that includes January 1 is set as week 1, and the value increases by 1 starting with the [Start of week] in the startup setting. (Refer to "■ Setting at startup (page 1-15)").
- When "Week day" is set in [Date/Time], the values will be as follows based on the week day set as the [Start of week] in the startup setting. (Refer to "■ Setting at startup (page 1-15)").
Set to "Sunday": Sunday = 1, Monday = 2 ... Saturday = 7
Set to "Monday": Monday = 1, Tuesday = 2 ... Sunday = 7

(4) Shift to right/Shift to left

When the number of string digits is smaller than the setting in "(6) Digit," selects to align the string to right or left. In this case, a space is inserted in the digit where "0" is entered. (With 0 suppression)

(Example)

<In the case of Year/Month/Day>

When the [Month]/[Day] digits are set to "2" (insert "/" as delimiter)

Shift to right: "2011/_6/_9"

Shift to left: "2011/6_/_9_" ("_" = space)

**Precautions for Correct Use**

Specify the "(4) Shift to right/Shift to left" settings before clicking "(9) [Add]."

(5) No zero suppression

This check box is selected when not performing zero suppression. (Excluding the [Week day] item.)

When set not to perform zero suppression, "0" is inserted in front of the string to match the number of digits set in "(6) Digit."

Marking result will be as follows.

(Example)

When the [Month]/[Day] digits are set to "2" (insert "/" as delimiter)

"2011/06/09"



Precautions for Correct Use

Specify the "(5) No zero suppression" setting before clicking "(9) [Add]."



Additional Information

When the check box for "(5) No zero suppression" is selected, the "(4) Shift to right/Shift to left" setting is disabled and "0" is inserted in front of the string.

(6) Digit

Sets the number of digits for date and time.

(7) Format

Selects the time format when "Hour" is selected in "(3) Date/Time."

- 12h: 12-hour format
- 24h: 24-hour format

Also, select the check box for [Show AM/PM] to mark text, "AM" and "PM" with [12h] selected. In this case, "AM" or "PM" will be marked to the left of the date and time.

(8) Reference date

When "Total No. of Days" is selected in "(3) Date/Time", selects the reference date.

- Julian Day: Noon on January 1, 4713 B.C.
- First Day of Year: January 1

Also, with "Julian Day" selected, to move the date up 1 day, selects "Move Up the Date".

(9) [Add]

The setting is additionally displayed in the "(1) Content" text box in the display code.



Additional Information

When "Total No. of Days" is selected in "(3) Date/Time", the total number of days passed from the selected reference date is displayed.



Reference

- "A.6 List of Display Codes (page A-23)"
-



Precautions for Correct Use

When date/time is set, the calculation time is affected depending on the marking data setting and screen operations may take longer than usual.

■ [Counter] tab setting items in the [Edit] dialog box

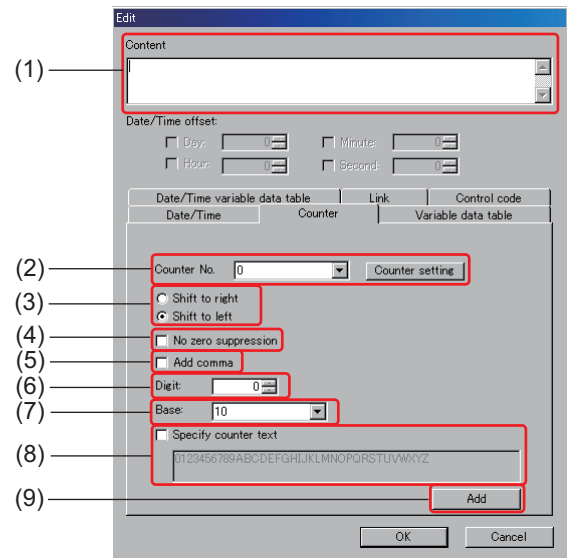

(1) Content

The setting is displayed with counter display codes.

Reference

- "A.6 List of Display Codes (page A-23)"

(2) Counter No.

Selects the counter number.

When registering a new counter setting or editing an existing counter setting, the [Counter setting] dialog box is displayed by clicking [Counter setting].

Additional Information

The counter setting can also be specified by selecting [Data] - [Counter] on the menu bar.

Reference

- "5.6 Counter Setting Function (page 5-45)"

(3) Shift to right/Shift to left

When the number of string digits is smaller than the setting in "(6) Digit," selects to align the string to right or left. In this case, a space is inserted in the digit where "0" is entered.

Marking result will be as follows depending on the setting.

(Example)

When the number of digits is set to "6" ("_" = space)

Shift to right: " _ _1234"

Shift to left: "1234 _ _"

Precautions for Correct Use

Specify the "(3) Shift to right/Shift to left" settings before clicking "(9) [Add]."

(4) No zero suppression

This check box is selected when not performing zero suppression.

When set not to perform zero suppression, "0" is inserted in front of the string to match the number of digits set in "(6) Digit."

Marking result will be as follows.

(Example)

When the number of digits is set to "6"
"001234"



Precautions for Correct Use

Specify the "(4) No zero suppression" setting before clicking "(9) [Add]."



Additional Information

When the check box for "(4) No zero suppression" is selected, the "(3) Shift to right/Shift to left" setting is disabled and "0" is inserted in front of the string.

(5) Add comma

This check box is selected when adding a delimiter comma (",") to the counter every 3 digits.

The marking will be as follows depending on the setting.

(Example)

Without comma: "12345"
With comma: "12,345"

(6) Digit

Sets the number of digits for the counter.

(7) Base

Sets the base of the counter.

(8) Specify counter text

This check box is selected and the counter text is entered in the text box when specifying the counter text to be marked.

Use this setting when skipping a certain text or replacing a text with another during marking.

(Example)

When upper case "I" and "O" is replaced by small case "i" and "o"
... GH*i*JKLMN*o*PQ ...

(9) [Add]

The setting is additionally displayed in the "(1) Content" text box with the counter display code.



Reference

- "A.6 List of Display Codes (page A-23)"
-

■ [Variable data table] tab setting items in [Edit] dialog box

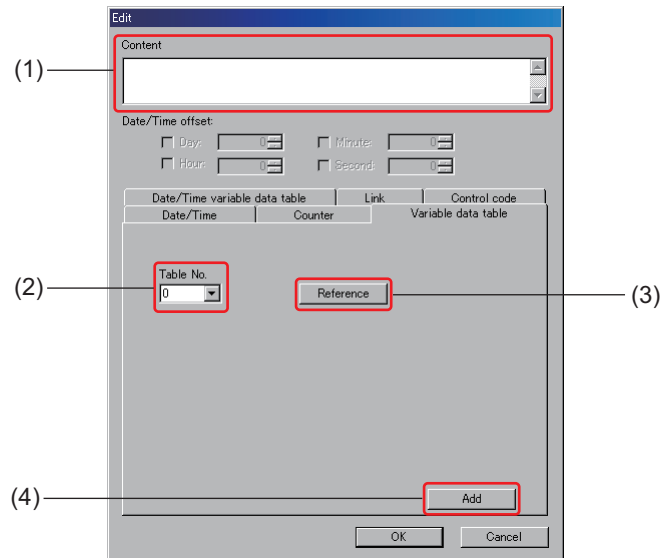

(1) Content

The setting is displayed with a variable data table display code.

(2) Table No.

Selects the data table number of the variable data table to be referenced.

(3) [Reference]

The variable data table selected in "(2) Table No." is displayed.

(4) [Add]

The setting is additionally displayed in the "(1) Content" text box with the variable data table display code.



Reference

- "A.6 List of Display Codes (page A-23)"
- " Setting Blocks Using the Variable Data Table (page 5-20)"

■ [Date/Time variable data table] tab setting items in [Edit] dialog box

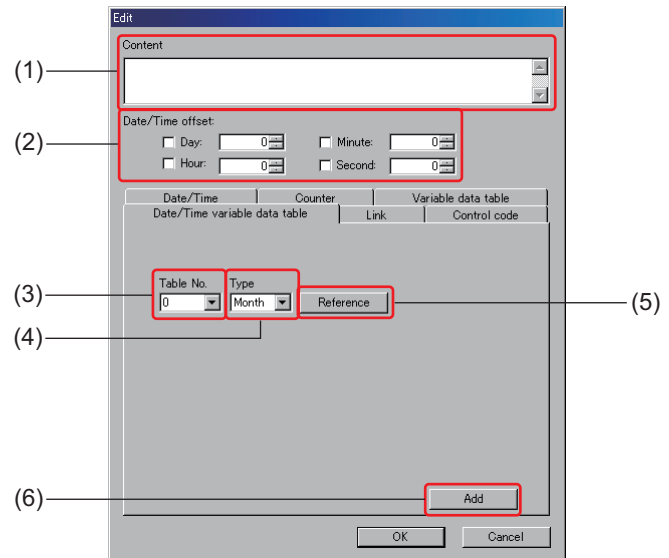

(1) Content

The setting is displayed with a date/time variable data table display code.

(2) Date/Time offset

The date and time data table in which the number of days and time set here are added to the current date and time is referenced for the selected date and time variable data table.

The check box for the item to offset ("Day," "Hour," "Minute," and "Second") is selected to set the number of days or time to be added.

The unit of each item applies.

If none is set, the current date and time are applied unchanged.

Note that, when this is set, the setting will be additionally displayed in the "(1) Content" text box in the Date/Time display code.

(3) Table No.

Selects the data table number of the date and time variable data table to be referenced.

(4) Type

Selects the date and time type of the date and time variable data table selected in "(3) Table No."

(5) [Reference]

The date and time variable data table selected in "(3) Table No." and "(4) Type" is displayed.

(6) [Add]

The setting is additionally displayed in the "(1) Content" text box with the date and time variable data table display code.



Reference

- "A.6 List of Display Codes (page A-23)"
- "Setting Blocks Using the Date/Time Variable Data Table (page 5-35)"

■ [Link] tab setting items in [Edit] dialog box

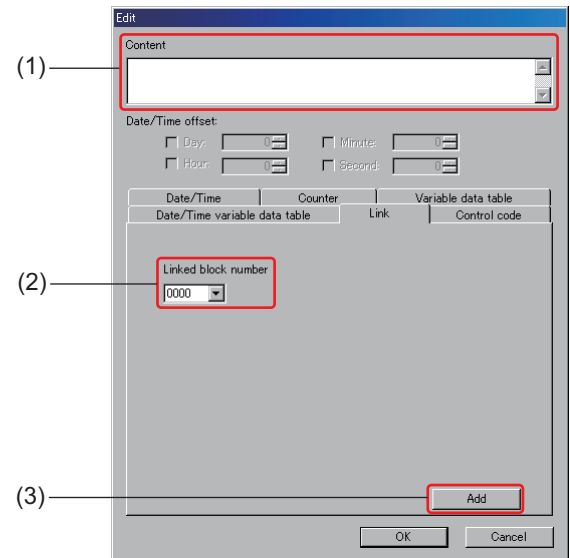

(1) Content

The setting is displayed with a link display code.

(2) Linked block number

Selects the block number to be linked for referencing the content.

(3) [Add]

The setting is additionally displayed in the "(1) Content" text box with the link display code.

Reference

- "A.6 List of Display Codes (page A-23)"
- "Link function (page 2-62)"

■ [Control code] tab setting items in [Edit] dialog box

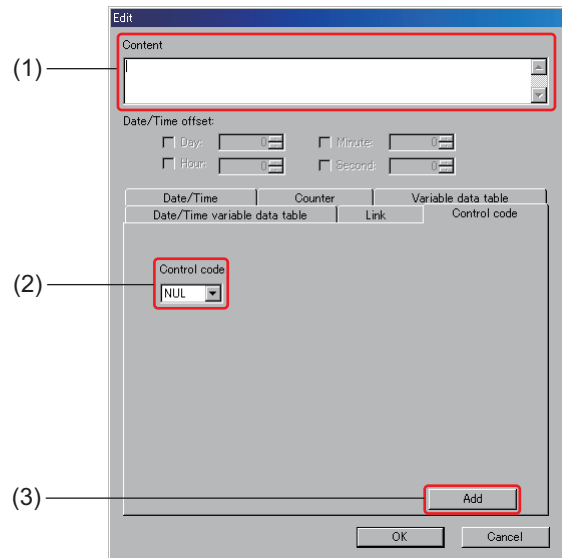

(1) Content

The setting is displayed with a display code.

(2) Control code

Selects the control code to add.

(3) [Add]

The setting is additionally displayed in the “(1) Content” textbox with a display code.



Reference

- "A.6 List of Display Codes (page A-23)"



Additional Information

For Data Matrix, “05 macro” and “06 macro” can be used together. Specify to enter the following at the beginning of the data.

Input	Special text	Content to be opened
@5	05 macro	[] > RS05GS “Data” RS EOT
@6	06 macro	[] > RS06GS “Data” RS EOT

[ID code] Block

The procedure for setting an [ID code] block is explained using the following as an example.

■ Setting

QR code of string, "ABCDEFGHJIJ123456," is marked to the work.

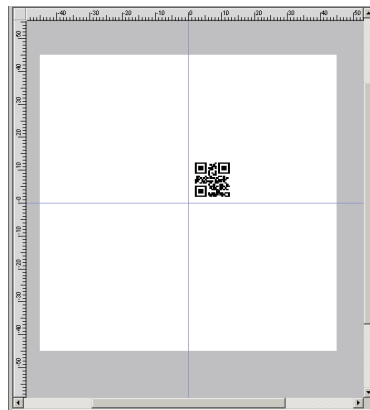

■ Setting procedure

- 1 Click  on the block menu, or click [Insert] on the menu bar and then select [ID code].
[ID code property] is displayed.

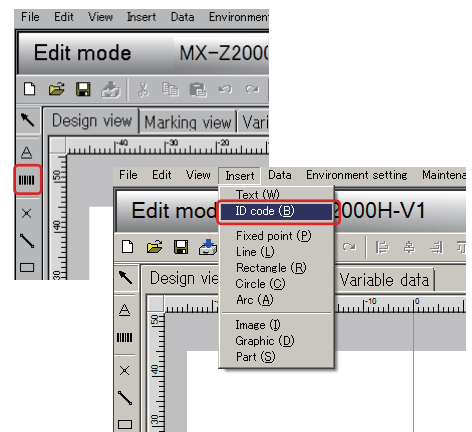

- 2 In the [String] text box, enter the string "ABCDEFGHJIJ123456" to be coded.

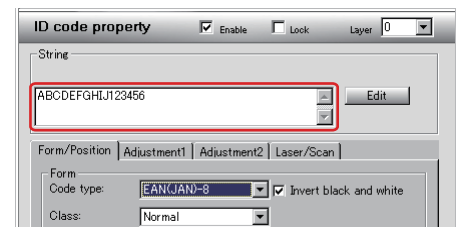

Additional Information

Up to 512 characters can be entered in the [String] text box.

3 Select the [Form/Position] tab and set the following items.

<Form>

- Code type : QR Code
- Class : Model 2
- Cell width/Cell height : 0.5 mm/0.5 mm
- Quiet zone : 4
- Cor. (Dark)/Cor. (Light) : 0 mm/0 mm
- Version : 1
- Correction level : Q (25%)

<Position>

- Starting point X/Starting point Y : 0 mm/0 mm
- Width/Height : 14.5 mm/14.5 mm

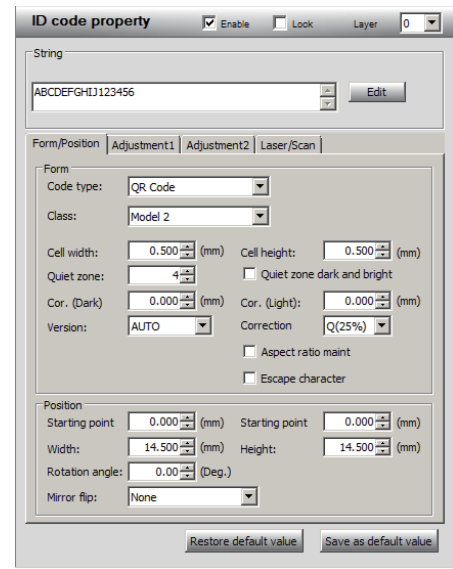

4 Click a blank area outside of the block on the sheet to confirm in the block.

The QR code of the specified string will be displayed on the sheet.

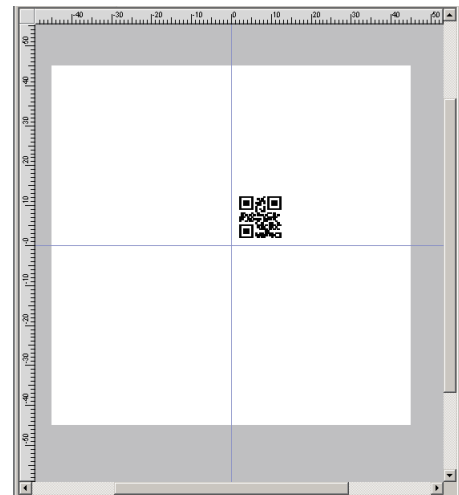

■ Explanations of the [ID code property] setting items

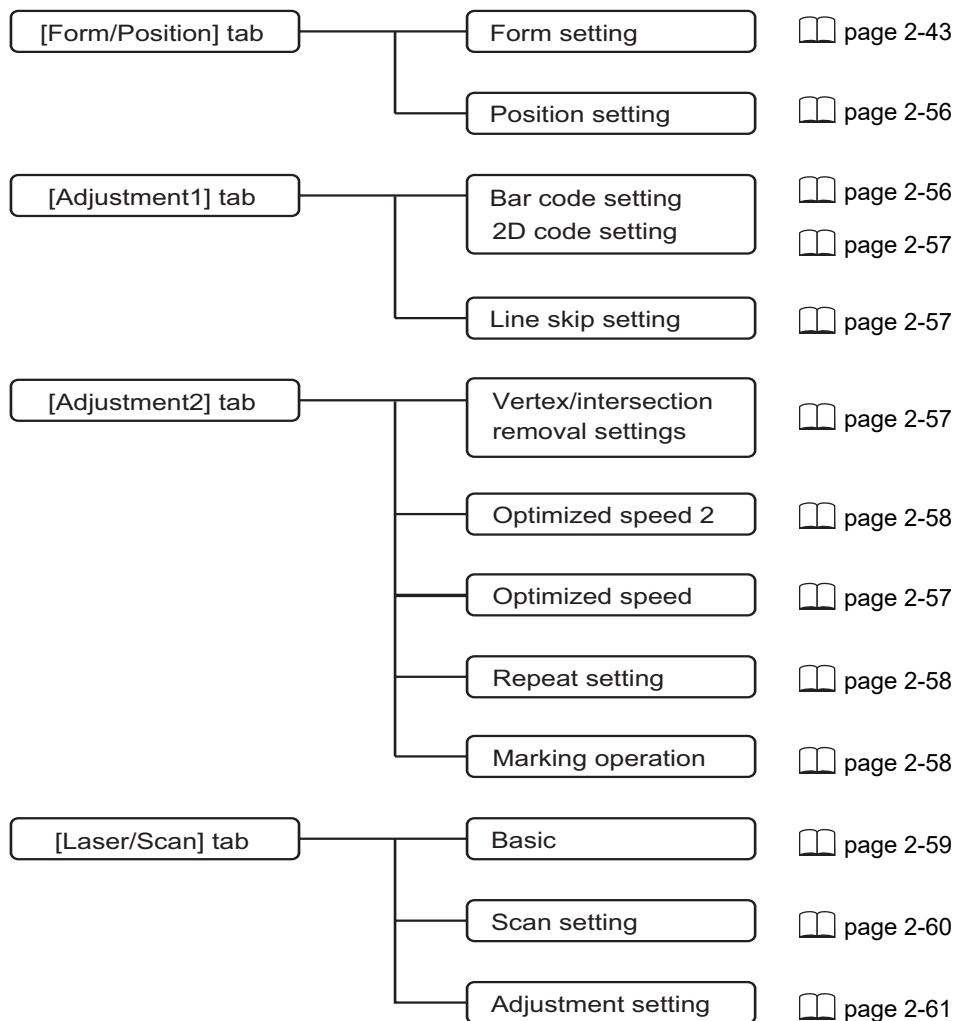

● [Form/Position] tab

◆ Form setting

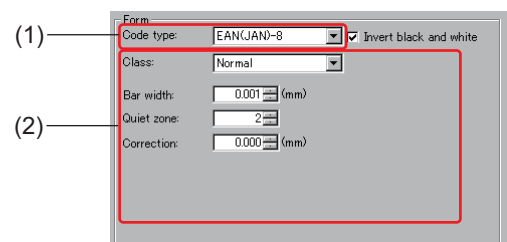

(1) Code type

Selects the ID code type.

(2) Code-specific parameters

The setting varies depending on the selected ID code.



Reference

Based on the selected ID code type, refer to one of the following pages:

- EAN (JAN) -8 (page 2-45)
 - EAN (JAN) -13 (page 2-45)
 - Codabar (NW-7) (page 2-46)
 - ITF (page 2-47)
 - Code39 (page 2-48)
 - GS1 Databar(page 2-51)
 - Code128 (page 2-49)
 - QR code (page 2-52)
 - Data Matrix (page 2-54)
 - GS1 Data Matrix (page 2-55)
-

◆ EAN (JAN) -13/EAN (JAN) -8

The data that can be handled is numbers (0 to 9) only, and the 13-digit standard version (EAN (JAN) -13) and the 8-digit short version (EAN (JAN) -8) are available.

• EAN(JAN)-13



• EAN(JAN)-8



(1) Class

Sets the model of the code to be marked.

- Normal: Standard model
- Add On: Add-on (additional code) model

(2) Bar width

Sets the width of the bar line.

(3) Quiet zone

Sets the magnification ratio of the quiet zone relative to the bar width.

The “(2) Bar width” changes according to the specified magnification ratio.

(4) Correction

Sets the amount of correction when fine-tuning need to be made because of the change in the module width due to smudging, etc. of the module border as a result of marking.

(5) Invert black and white

This check box is selected to invert black and white for marking.

In that case, the quiet zone will also be marked.

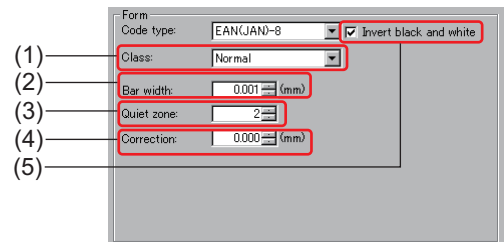

Additional Information

Check digit is automatically added. The number of digits that can be entered is 7 digits for EAN (JAN) -8, and 12 digits for EAN (JAN) -13. If [String] is less than the number of digits that can be entered, “0” is added at the end.

◆ Codabar (NW-7)

The data that can be handled include numbers (0 to 9), symbols (+ – \$: / or .), or start/stop characters (A to D), and there is no limit to the number of digits.



(1) Bar width

Sets the width of the bar line.

(2) Quiet zone

Sets the magnification ratio of the quiet zone relative to the bar width.

The “(1) Bar width” changes according to the specified magnification ratio.

(3) Correction

Sets the amount of correction when fine-tuning need to be made because of the change in the module width due to smudging, etc. of the module border as a result of marking.

(4) Bar width ratio

Sets the width of the bold line when the thin line is set to 1.

(5) Invert black and white

This check box is selected to invert black and white for marking.

In that case, the quiet zone will also be marked.

(6) Check digit

This check box is selected to add the check digit at the end of the string.

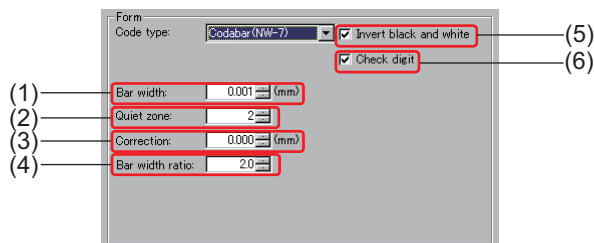

Additional Information

- When the start character is omitted from [String], “A” is added to the bar code as the start character.
- When the stop character is omitted from [String], a stop character is added to the bar code.

◆ ITF

The data that can be handled is numbers (0 to 9) only, and the number of digits must be an even number. The standard model and the bearer bar model with a black frame are available.

**(1) Class**

Sets the model of the code to be marked.

- Standard: Standard model
- Bearer Bar: Bearer bar model

(2) Bar width

Sets the width of the bar line.

(3) Quiet zone

Sets the magnification ratio of the quiet zone relative to the bar width.

The “(2) Bar width” changes according to the specified magnification ratio.

(4) Correction

Sets the amount of correction when fine-tuning need to be made because of the change in the module width due to smudging, etc. of the module border as a result of marking.

(5) Bar width ratio

Sets the width of the bold line when the thin line is set to 1.

(6) Invert black and white

This check box is selected to invert black and white for marking.
In that case, the quiet zone will also be marked.

(7) Check digit

This check box is selected to add the check digit at the end of the string.

The screenshot shows a 'Form' window for ITF marking data. The fields and their values are: Code type: ITF; Class: Standard; Bar width: 0.001 (mm); Quiet zone: 2; Correction: 0.000 (mm); Bar width ratio: 2.0; Invert black and white: checked; Check digit: checked. Red boxes highlight the Class, Bar width, Quiet zone, Correction, Bar width ratio, Invert black and white, and Check digit fields. Numbered callouts (1) through (7) point to these fields respectively.

**Additional Information**

When the [String] is an odd digit without check digit, or the [String] is an even digit with check digit, “0” is added at the end of the string.

◆ Code39

The data that can be handled include numbers (0 to 9), upper case alphabet characters (A to Z), symbols (+ – \$ / . % or space), and there is no limit to the number of digits.



(1) Bar width

Sets the width of the bar line.

(2) Quiet zone

Sets the magnification ratio of the quiet zone relative to the bar width.

The “(1) Bar width” changes according to the specified magnification ratio.

(3) Correction

Sets the amount of correction when fine-tuning need to be made because of the change in the module width due to smudging, etc. of the module border as a result of marking.

(4) Bar width ratio

Sets the width of the bold line when the thin line is set to 1.

(5) Invert black and white

This check box is selected to invert black and white for marking. In that case, the quiet zone will also be marked.

(6) Check digit

Specifies whether or not to add the check digit at the end of the string.

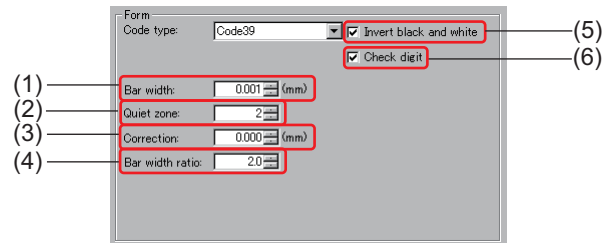

Additional Information

Even if start/stop character, “*,” is omitted from the [String], the start/stop character is added to the bar code.

◆ Code128

The data that can be handled are all ASCII characters (128 characters), and there is no limit to the number of digits.



(1) Class

Sets the model of the code to be marked.

- Code Set A: Combination of alphanumeric characters (upper case) and control characters
- Code Set B: ASCII character combination
- Code Set C: Combination of numbers (00 to 99) only
- Code Set Auto: Characters automatically combined

(1)
(2)
(3)
(4)

(5)

(2) Bar width

Sets the width of the bar line.

(3) Quiet zone

Sets the magnification ratio of the quiet zone relative to the bar width.

The "(2) Bar width" changes according to the specified magnification ratio.

(4) Correction

Sets the amount of correction when fine-tuning need to be made because of the change in the module width due to smudging, etc. of the module border as a result of marking.

(5) Invert black and white

This check box is selected to invert black and white for marking.

In that case, the quiet zone will also be marked.



Additional Information

When entering an ASCII control code to a [String], enter @Escape. (Refer to the next paragraph.)

◆ @Escape input method

Input text and the meanings for Code Sets A, B, and C (Special text and control code)

Input	Code A	Code B	Code C	Meaning
@@	@	@		@Escape text itself
@1	FNC1	FNC1	FNC1	Func 1
@2	FNC2	FNC2		Func 2
@3	FNC3	FNC3		Func 3
@4	FNC4	FNC4		Func 4
@A		Code A	Code A	Switch Code Set to A.
@B	Code B		Code B	Switch Code Set to B.
@C	Code C	Code C		Switch Code Set to C.
@D	US	DEL		US (0 × 1F) or Delete (0 × 7F)
@S	SHIFT	SHIFT		Text shift indicator

Input text and the meanings in Code Sets A and B

Input	Code A	Code B	Input	Code A	Code B	Input	Code A	Code B
Sp	Sp	Sp	0	0	0	@@	@	@
!	!	!	1	1	1	A	A	A
"	"	"	2	2	2	B	B	B
#	#	#	3	3	3	C	C	C
\$	\$	\$	4	4	4	D	D	D
%	%	%	5	5	5	E	E	E
&	&	&	6	6	6	F	F	F
'	'	'	7	7	7	G	G	G
(((8	8	8	H	H	H
)))	9	9	9	I	I	I
*	*	*	:	:	:	J	J	J
+	+	+	;	;	;	K	K	K
,	,	,	<	<	<	L	L	L
-	-	-	=	=	=	M	M	M
.	.	.	>	>	>	N	N	N
/	/	/	?	?	?	O	O	O

Input	Code A	Code B	Input	Code A	Code B	Input	Code A	Code B
P	P	P	`	NUL	`	p	DLE	p
Q	Q	Q	a	SOH	a	q	DC1	q
R	R	R	b	STX	b	r	DC2	r
S	S	S	c	ETX	c	s	DC3	s
T	T	T	d	EOT	d	t	DC4	t
U	U	U	e	ENQ	e	u	NAK	u
V	V	V	f	ACK	f	v	SYN	v
W	W	W	g	BEL	g	w	ETB	w
X	X	X	h	BS	h	x	CAN	x
Y	Y	Y	i	HT	i	y	EM	y
Z	Z	Z	j	LF	j	z	SUB	z
[[[k	VT	k	{	ESC	{
¥	¥	¥	l	FF	l		FS	
]]]	m	CR	m	}	GS	}
^	^	^	n	SO	n	~	RS	~
_	_	_	o	SI	o	@D	US	DEL

◆ GS1 Databar

The data that can be handled include numbers (0 to 9), upper case alphabet characters (A to Z), lower case alphabet characters (a to z), and symbols (+ - / . % ! " or space), but the data and number of digits that can be handled vary depending on the class.



(1) Class

Sets the model of the code to be marked.

- Omni (Omnidirectional): Numbers only
- Truncated: Numbers only
- Limited: Numbers only
- Expanded: Numbers, upper case alphabet characters, lower case alphabet characters, symbols

(2) Bar width

Sets the width of the bar line.

(3) Quiet zone

Sets the magnification ratio of the quiet zone relative to the bar width.

The "(2) Bar width" changes according to the set magnification ratio.

(4) Cor. (Dark)/Cor. (Light)

Sets the amount of correction when fine-tuning need to be made because of the change in the module width due to smudging, etc. of the module border as a result of marking.



Reference

For details on GS1 Databar data input, refer to:

- "GS1 Databar and GS1 Data Matrix Setting Methods (page 2-64)"

◆ QR code

Alphanumeric characters, single-byte katakana, kanji, etc. can be used. The amount of data varies depending on the conditions.

• QR code



• Micro QR code



(1) Class

Sets the model of the code to be marked.

- Model 1: QR code Model 1
- Model 2: QR code Model 2
- MicroQR: Micro QR code

(2) Cell width/Cell height

Sets one cell width/height.

Set the same value for cell width/height.

(3) Quiet zone

Sets the number of modules in the quiet zone.

(4) Cor. (Dark)/Cor. (Light)

Sets the amount of correction when fine-tuning need to be made because of the change in the module width due to smudging, etc. of the module border as a result of marking.

(5) Version

Sets the code versions (Model 1: AUTO (automatic), 1 to 14, Model 2: AUTO (automatic), 1 to 40, or MicroQR: AUTO (automatic), 1 to 4).

(6) Quiet zone dark and light

Switches the quiet zone marking settings between the dark and light modules.

When this check box is not selected, the light module is used.

(7) Correction level

Sets the ratio of word correction to be added to correct the codes that can no longer be read due to the code being dirty or damaged.

- L (7%): A 7% area of the entire code can be restored.
- M (15%): A 15% area of the entire code can be restored.
- Q (25%): A 25% area of the entire code can be restored.
- H (30%): A 30% area of the entire code can be restored.

(8) Aspect ratio maint

When the block size is changed, expands/contracts keeping the original aspect ratio for the QR code.

(9) Escape character

This check box is selected when entering characters in \xx format in [String] or when entering a line feed.



Additional Information

Refer to the next page for details of [String] input at the time of escape character check.

◆ [String] input contents and generation result at the time of escape character check

* Reading contents of generated 2D code are based on the code reader specification.

input content	Escape character check	
	checked	no check
Character input using \ symbol	Possible	Impossible
Control code input by [Control code] tab setting	Possible	Impossible
Line feed input	Possible	Impossible

◆ Input contents and generation results to [String] using \ symbol

When checking escape character, it is possible to input ASCII character corresponding to xx by inputting two hexadecimal digits of \ xx format in [String].

input content	generation result	concrete example		description
		input	result	
\ xx	xx	\0A	(LF)	If the two digits xx following the \ symbol correspond to a hexadecimal two digit ASCII code, Treats \ xx as ASCII code and generates 2D code.
		\1D	(GS)	
		\41	A	
		\120	(DC2)0	
\ only	\	\	\	If there is no character after the \ symbol, it is treated as a \ symbol.
\\	\	\\	\	If you enter the \ symbol continuously, it will be treated as the \ symbol.
\ G	G	\ABC	ABC	If you enter the \ symbol with an input other than \ xx or \\, the \ symbol is removed.
		\B\B	BB	
		\00	00	However, if there is no character following the \ symbol, it is treated as the \ symbol.
		\ABC\	ABC\	
ABC	ABC	123	123	Input character itself

(Example) Input: 123\1D\\500\1DABC → Generate: 123(GS)\500(GS)ABC

◆ Control code input by [Control code] tab setting

When checking escape character, it becomes possible to input the control code set in [Control code] tab (Control code  page A-25) to [String].

For example, if GS is selected on the [Control Code] tab, it will be as follows.

Escape character check	Selection control code	[String] Displayed Content	Generation result
checked	GS	%x1D%	Control code: (GS)
no check			String: @29

◆ Line feed input

When checking escape character, Line feed can be input to [String].

Escape character check	Generation result
checked	Code generation is possible
no check	Code generation is impossible

◆ Data Matrix

Various types of data, such as alphanumeric characters and symbols, can be used. The amount of data varies depending on the conditions. The square model and the rectangle model are available.

• Square model



• Rectangle model



(1) Class

Sets the model of the code to be marked.

- Ecc200 Square: ECC200 square
- Ecc200 Rectangular: ECC200 rectangle

(2) Cell width/Cell height

Sets one cell width/height.

Set the same value for cell width/height.

(3) Quiet zone

Sets the number of modules in the quiet zone.

(4) Cor. (Dark)/Cor (Light)

Sets the amount of correction when fine-tuning need to be made because of the change in the module width due to smudging, etc. of the module border as a result of marking.

(5) Symbol size

Sets the symbol size (number of cells excluding the quiet zone).

(6) Quiet zone dark and light

Switches the quiet zone marking settings between the dark and light modules.

When this check box is not selected, the light module is used.

(7) Escape character

This check box is selected when entering characters in \xx format in [String] or when entering a line feed.



Additional Information

Details about [String] input at the time of escape character check (refer to page 2-53)



Additional Information

- With this system, the following control code can be entered as @Escape.

Input	Code	Content to be opened
@@	@	-
@1	FUNC1	-
@5	05 macro	@5 05 macro [] > RS05GS "Data" RS EOT
@6	06 macro	@6 06 macro [] > RS06GS "Data" RS EOT

◆ GS1 Data Matrix

The data that can be handled include numbers (0 to 9), upper case alphabet characters (A to Z), lower case alphabet characters (a to z), and symbols (+ - / . % ! " or space), but the number of digits that can be handled varies depending on the class.



(1) Class

Sets the model of the code to be marked.

- Ecc200 Square:ECC200 square
- Ecc200 Rectangular:ECC200 rectangle

The screenshot shows a configuration window titled 'Form' for 'GS1 Data Matrix'. The settings are as follows:

- (1) Class: Ecc200 Rectangular
- (2) Cell width: 0.300 (mm), Cell height: 0.300 (mm)
- (3) Quiet zone: 2, Quiet zone dark and bright:
- (4) Cor. (Dark): 0.000 (mm), Cor. (Light): 0.000 (mm)
- (5) Symbol size: AUTO
- (7) Escape character:

(2) Cell width/Cell height

Sets the width/height of a cell.

Set the same value for cell width/height.

(3) Quiet zone

Sets the number of modules in the quiet zone.

(4) Cor. (Dark)/Cor. (Light)

Sets the amount of correction when fine-tuning need to be made because of the change in the module width due to smudging, etc. of the module border as a result of marking.

(5) Symbol size

Sets the symbol size (number of cells excluding the quiet zone).

(6) Quiet zone dark and light

Switches the quiet zone marking settings between the dark and light modules.

When this check box is not selected, the light module is used.

(7) Escape character

This check box is selected when entering characters in \ xx format in [String] or when entering a line feed.



Additional Information

Details about [String] input at the time of escape character check (refer to page 2-53)



Reference

For details on GS1 Data Matrix data input, refer to:

- "GS1 Databar and GS1 Data Matrix Setting Methods (page 2-64)"

◆ **Position setting**

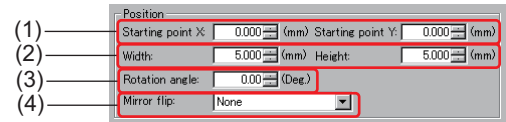

(1) Starting point X/Starting point Y

Sets coordinate X and coordinate Y of the reference point (lower left).

(2) Width/Height

Sets the ID code width and height.

(3) Rotation angle

Sets the rotation angle against the X-axis of the ID code.
The code is rotated to the left at the specified angle.

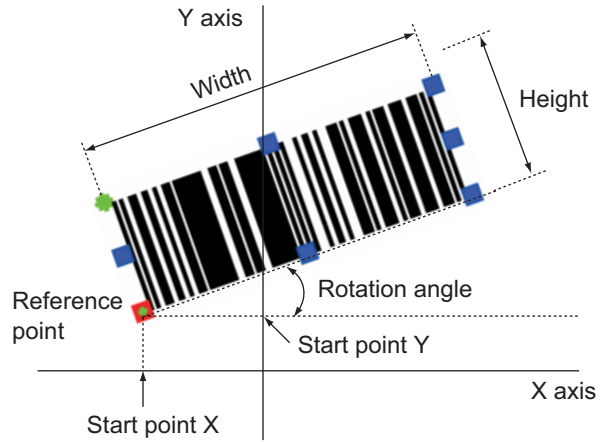

(4) Mirror flip

One of the following is selected to flip the ID code.

- Left/Right
- Up/Down
- Up/Down/Left/Right

● **[Adjustment1] tab**

◆ **Bar code setting**

Sets the following fill-related settings when marking a bar code.

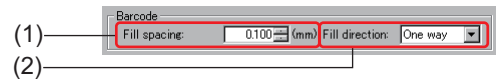

(1) Fill spacing

Sets the spacing between fill lines of the bar code.

(2) Fill direction

- Round trip: Fills both directions.
- One way: Fills one direction.

◆ 2D code setting

Sets the following fill-related settings when marking a 2D code.

Specify the settings separately for “Light module” and “Dark module.”

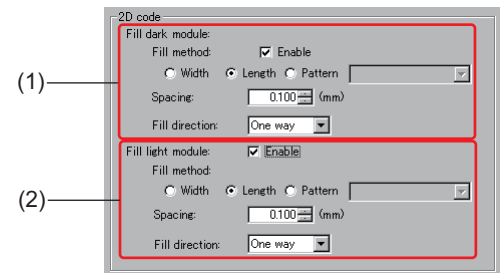

(1) Fill dark module

The [Enable] check box is selected when filling the dark module.

When this is enabled, sets the fill method.

- Width: Fills in the lateral direction.
- Length: Fills in the vertical direction.
- Pattern: Fills in the selected pattern.



Additional Information

Create and register the fill patterns that can be selected here using the Font logo editor (Refer to "Chapter 11 How to Use Font Logo Editor (page 11-1)").

When [Width] or [Length] is set, set the fill spacing in [Spacing] and the fill direction [Round trip]/[One way] in [Fill direction].

(2) Fill light module

The [Enable] check box is selected when filling the light module.

When this is enabled, sets the fill method, spacing and direction.

The settings are the same as “Fill dark module” above.

◆ Line skip setting

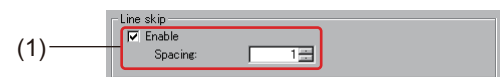

(1) Enable/Spacing

This check box is selected to enable line skip for fill (skipping every few lines to avoid heat effects) and to set the spacing between the lines (at every how many line the text should be filled).

● [Adjustment2] tab

◆ Vertex/intersection removal settings

The settings are the same as those of the [Text] blocks.



Reference

- "◆ Vertex/intersection removal settings (page 2-27)"

◆ Optimized speed

The settings are the same as those of the [Text] blocks.



Reference

- "◆ Optimized speed (page 2-27)"

◆ Optimized speed 2

Makes the path of the laser as straight as possible and reduces the number of direction changes to improve marking accuracy.

• When Optimized Speed is enabled

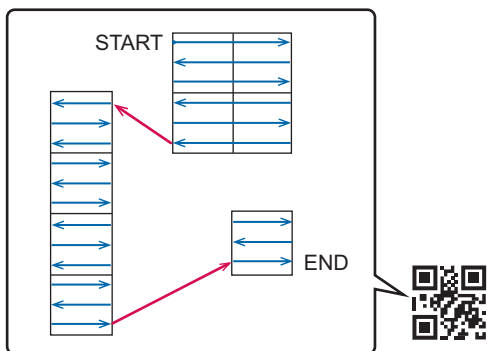

• When Optimized Speed 2 is enabled

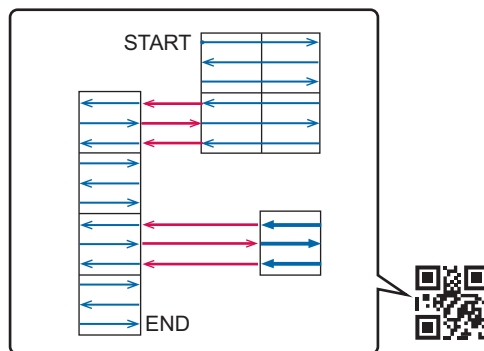

↔ Laser exposure point and scanning direction

↔ Movement path

□ ID code marking area

(1) Enable

Select the [Enable] check box to enable the optimized speed 2.

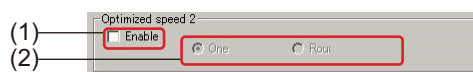

(2) [One way]/[Round trip]

[One way] offers a high degree of marking accuracy, and [Round trip] offers a shorter processing time.



Additional Information

Optimized speed 2 and Optimized speed (in the previous section) cannot be enabled at the same time.

◆ Repeat setting

The settings are the same as those of the [Text] blocks.



Reference

- "◆ Repeat setting (page 2-28)"

◆ Curve surface correction

The settings are the same as those of the [Text] blocks.



Reference

- "◆ Curve surface correction (page 2-28)"

◆ Marking operation

The settings are the same as those of the [Text] blocks.



Reference

- "◆ Marking operation (page 2-28)"

● [Laser/Scan] tab

◆ Basic

Specifies the basic laser setting.

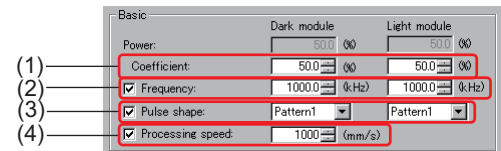

(1) Coefficient

Sets the laser power coefficient set in [Common setting].

The value of laser power specified in [Common setting] is multiplied with the coefficient set here, and the result is shown in [Power] at the top as the set value of the laser power for this block.

Specify the settings separately for "Dark module" and the "Light module."

The power will be limited at or below the 100kHz frequency due to the pulse shape.

📖 Reference

For details on coefficients, refer to:

- "■ [Laser/Scan] tab (page 2-115)"

Maximum laser power

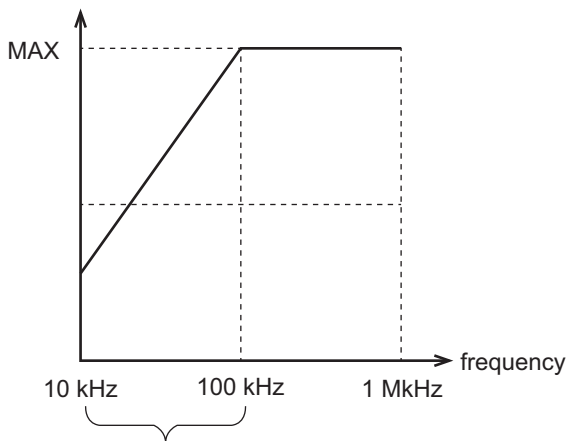

Output restricted

Graph showing restricted laser power when pulse pattern 1 is set

Laser power

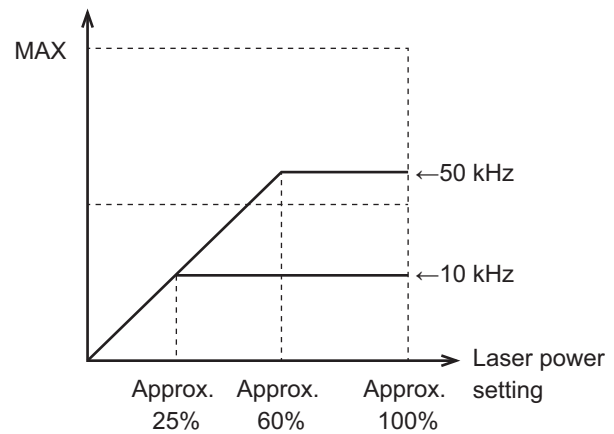

📄 Precautions for Correct Use

Laser power that is set too high may burn and damage the work depending on its material. Perform test marking and check the work condition when setting this value.

(2) Frequency

When setting the laser pulse frequency, the most appropriate frequency is set, taking the work material, etc. into account.

The frequency can be adjusted in the range between 10.0 and 1000.0 kHz in the standard mode, and in the range between 10.0 to 100.0 kHz in the EE mode.

Specify the settings separately for "Dark module" and the "Light module."

📖 Reference

For details on how to switch between the standard mode and EE mode, refer to:

- "◆ EE Mode Setting (page 6-24)"

(3) Pulse shape

Sets the pulse shape of the laser.

The pulse count fluctuates in the range between 7.5 and 300 ns from “Pattern 1” to “Pattern 15” in the standard mode, and in the range between 150 and 450 ns from “Pattern 1” to “Pattern 3” in the EE mode, and the heating time can be adjusted.

Sets the most appropriate pattern based on the work material and purpose.

The group of pulses specified in this pulse shape is emitted in the cycle specified in “(2) Frequency”.

Specify the settings separately for “Dark module” and the “Light module.”

- The laser pulse pattern and the actual number of pulses in the standard mode.

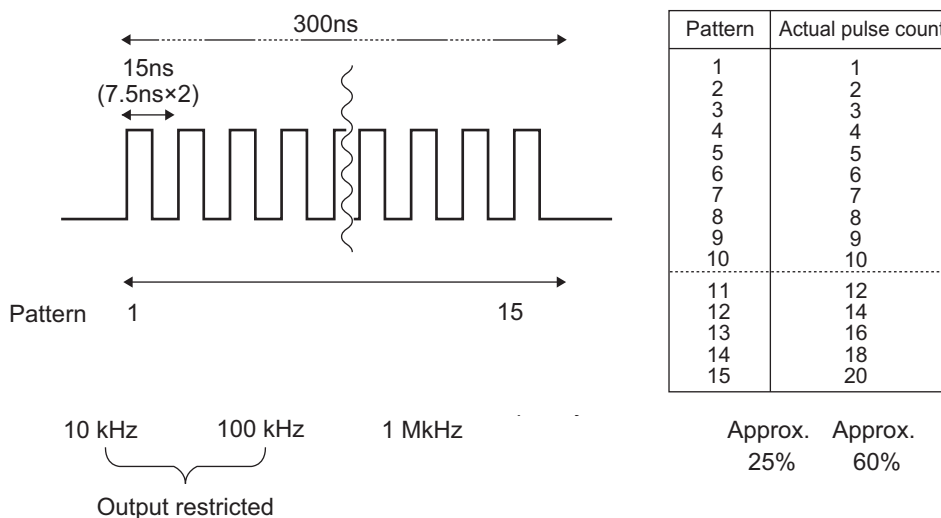

Graph showing restricted laser power when pulse pattern 1 is set

(4) Processing speed

Sets the moving speed when the laser is continuously being emitted (when marking).

◆ Scan setting

Specifies the scan settings.

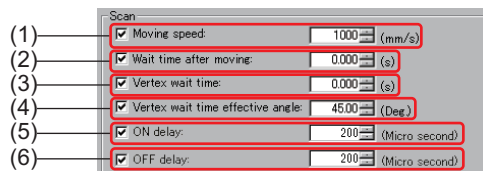

(1) Moving speed

Sets the moving speed when the laser is moving between characters or moving to a remote location.

(2) Wait time after moving

Sets the wait time until the next marking after the laser moved.

(3) Vertex wait time

Sets the wait time until the system starts to mark another line after finishing marking a line when marking a vertex.

(4) Vertex wait time effective angle

Sets the angle at which the vertex wait is enabled.

The vertex wait is enabled when the angle is smaller than the value set here.

(5) ON delay

This is set to apply delay time after marking is started and until the laser is actually emitted.

(6) OFF delay

This is set to apply delay time after marking is completed and until the laser is actually emitted.

◆ Adjustment setting

Specifies the adjustment settings.

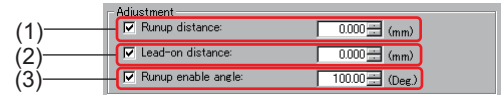
**(1) Runup distance**

Sets the distance (runup distance) to start marking another line after finishing marking a line when marking a vertex.

(2) Lead-on distance

Sets the lead-on distance after the marking of a line is finished when marking a vertex.

**Additional Information**

The longer the specified "(1) Runup distance" and "(2) Lead-on distance" are, the sharper the vertex angle will be. Note, however, that the marking speed will go down.

(3) Runup enable angle

Sets the angle at which the runup line is enabled.

The runup line is enabled when the angle is smaller than the value set here.

**Additional Information**

- The laser, runup line, and scanning settings are usually set through the [Laser/Scan] tab in the [Common setting] and used as the common settings for all marking data. (Refer to "2.7 Common Setting (page 2-108)"). Set individual settings through the [Laser/Scan] tab in the properties for each block individually when it is necessary to set values that are different from the common setting. Excluding [Coefficient] and [Power], any items that are checked will become effective as an individual setting for that block which is independent from the [Common setting].
- Click [Restore default value] to restore the default value. Furthermore, click [Save as default value] to save the settings on the screen as the default values. Note, however, that the above is not applicable to the [String] settings and the [Position] settings in the [Form/Position] tab.
- Click [Environment setting] on the menu bar, and then select [Reset to default value] to restore the factory default settings. (Refer to "6.5 Reset to default value (page 6-14)")



Additional Information

Link function

The Link function can be used to have the specified block reference the set text data. For example, by linking the [ID code] block that has been created to a [Text] block, the corresponding ID code can be displayed when the setting in the [Text] block is changed.

However, if [Date/Time offset] is set for the linked view block, the [Date/Time offset] setting will not be reflected. To create marking data with the same date and time as the linked block, set the [Date/Time offset] of the block on which the link is set to the same value as the [Date/Time offset] of the linked block.



Reference

- "■ [Date/Time] tab setting items in the [Edit] dialog box (page 2-32)"
- "■ [Date/Time variable data table] tab setting items in [Edit] dialog box (page 2-38)"

The procedure for the example above is explained below.

[1] Create the [Text] block (block No. 0).

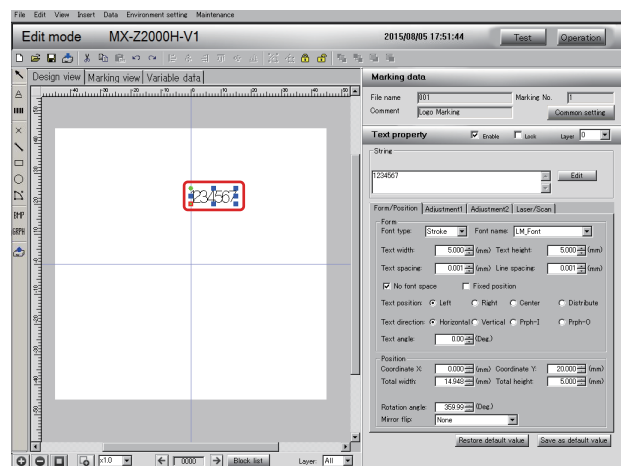

[2] Select the [ID code] block and click [Edit] under [ID code property].

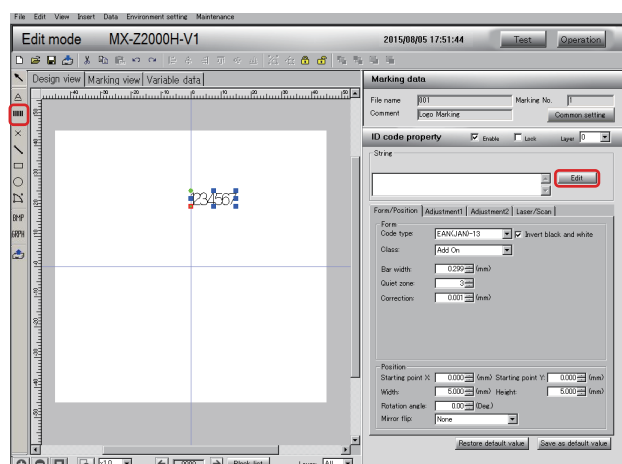

- [3] Select the [Link] tab, and specify the block number, "0," for the [Text] block to be linked and used to reference the content in [Linked block number], and click [Add].
 The [Content] will display the display code, "%B***%," of the linked text (** is the linked block number).
 (Refer to "A.6 List of Display Codes (page A-23)")

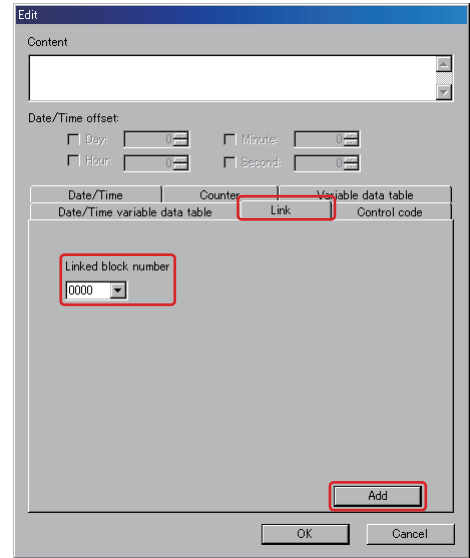

- [4] Click [OK].
 The code will be linked to the [Text] block.
 [5] Set the ID code form/position in the [ID code property].

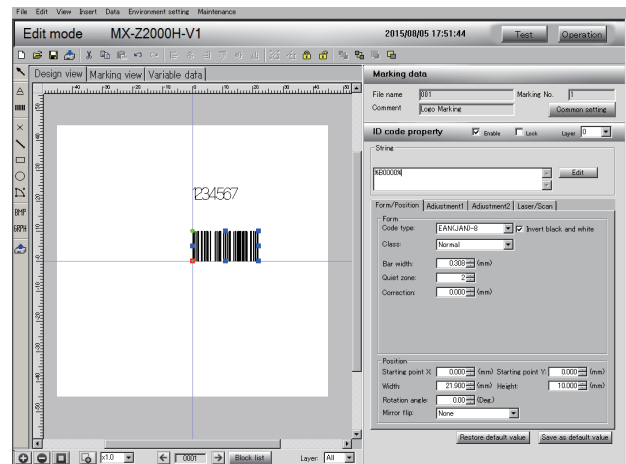
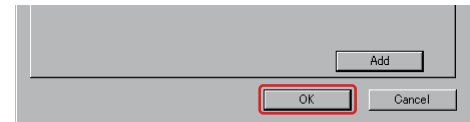

- [6] When the string in the linked [Text] block is changed, the ID code will change accordingly.

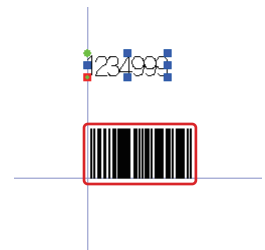

■ **GS1 Databar and GS1 Data Matrix Setting Methods**

When GS1 Databar/GS1 Data Matrix is selected in [Code type], the string to encode cannot be entered directly in the

[String] text box in the ID code property.

To edit data, click the [Edit] button to display the [Edit] dialog box.

(1) Desc

A list of descriptions in (4) and (7) that are set in this dialog box is displayed.

(2) Del

Press this button with an AI and its set value selected in (1) to delete the selected item.

(3) Category

Select the large items of AIs.

- Identification No.
- Price
- Size
- Y/M/D
- Other

(4) AI

Select an AI.

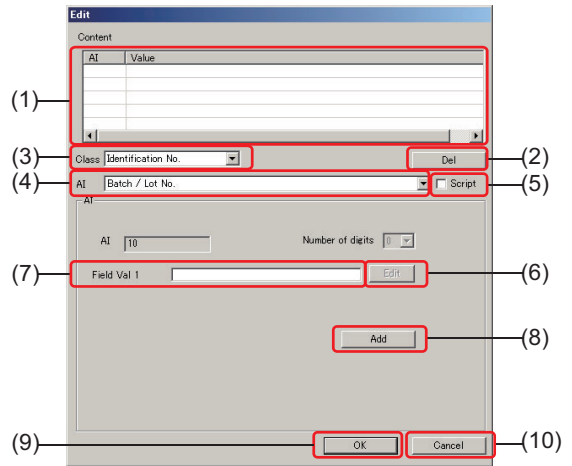

Reference

For details on AIs, refer to:

- "♦ GS1 Code AI List (page A-26)"

(5) Script

Check this box when you wish to enter script characters in (7).

(6) Edit

A dialog box for editing script characters is displayed. This is enabled only when (5) is checked.

(7) Field Val/Dir I/P

Enter the value that comes after the AI.

When [GTIN] is selected in (4), [Dir I/P] is shown here.

**Additional Information**

With GS1 codes, the number of characters required is set for each AI.

When a value is entered in the [Edit] dialog box, the following processing will be performed.

- When a fixed-length AI is selected:
If the entered value does not reach the required number of characters and [Script] is not checked, required number of "0s" are filled between the AI and the value by the software. In addition, a check digit is automatically added by this software for GTIN (01) only when the first AI is set to GTIN (01). This additional check digit is not displayed in the value of (1) and the ID code property string column. Therefore, when setting the values of communication commands, etc., do not add a check digit.
 - When a variable-length AI is selected:
The code is generated with "@1 (FNC)" added to the end of the field value. However, when the final data of the variable-length AI is set and the [OK] button (9) is pressed, the "@1 (FNC1)" at the end is deleted.
-

(8) Add

The set AI and the value are added to (1).

(9) OK

The descriptions registered in the list are registered in the [String] text box, then the dialog box is closed.

(10) Cancel

The dialog box is closed.

**Additional Information**

To edit the generated block in this dialog box again, the generated AI and the value are cleared.

[Fixed point] Block

The procedure for setting an [Fixed point] block is explained using the following as an example.

■ **Setting**

Mark for 1 second at the specified work coordinate position (coordinate X: 10 mm/coordinate Y: 10 mm).

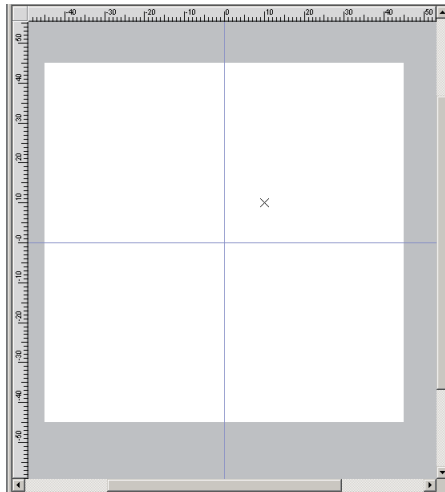

■ **Setting procedure**

- 1 Click **x** on the block menu, or click **[Insert]** on the menu bar and then select **[Fixed point]**.
[Fixed point property] is displayed.

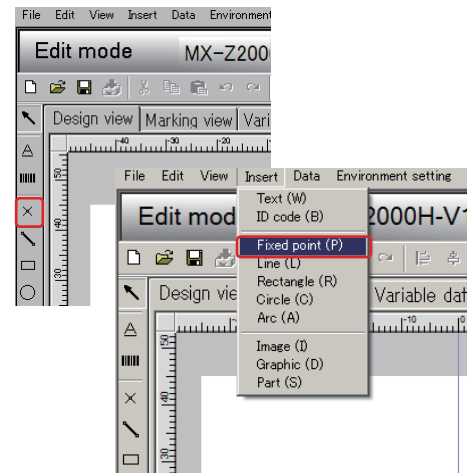

- 2 Click on the sheet to set the fixed point.

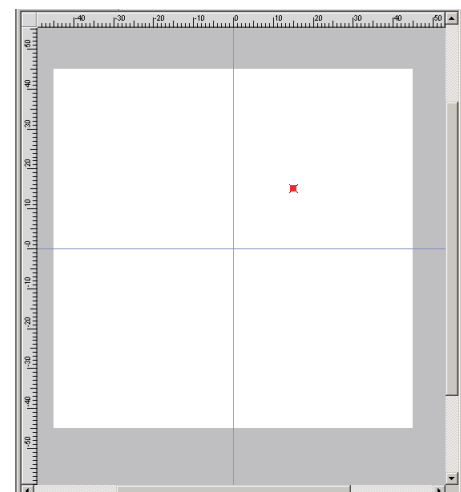

3 Select the [Form/Position] tab and set the following items.

<Form>

- Laser ON time : 1000 ms

<Position>

- Coordinate X/Coordinate Y : 10 mm/10 mm

<Repeat>

- Repeat count : 1

Fixed point property Enable Lock Layer 0

Form/Position Laser/Scan

Form
Laser ON time: 1000 (ms)
Laser OFF time: 0 (ms)

Position
Coordinate X: 10.000 (mm) Coordinate Y: 10.000 (mm)

Repeat
Repeat count: 1

Restore default value Save as default value

4 Click a blank area outside of the block on the sheet to confirm in the block.

The fixed point is set based on the conditions specified for the sheet.

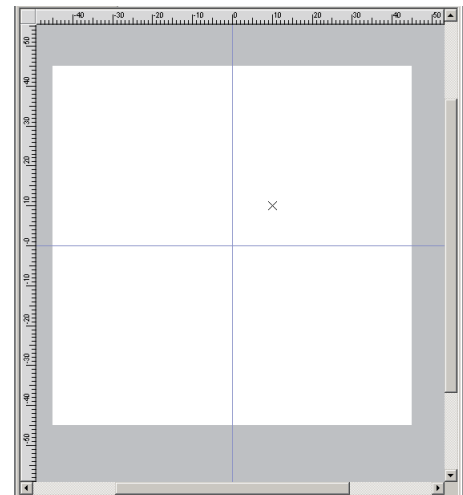

■ [Fixed point property] setting items

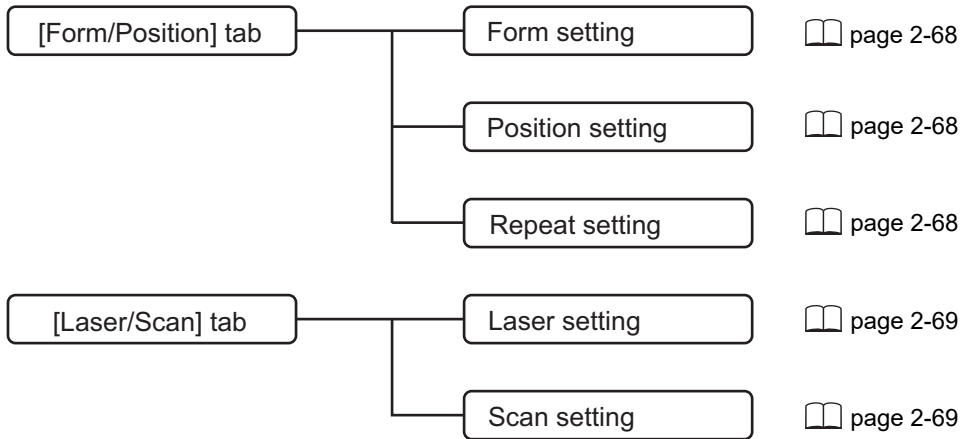

● [Form/Position] tab

◆ Form setting

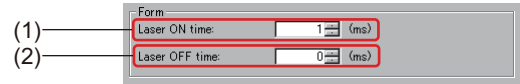

(1) Laser ON time

Sets the laser emission time.

The longer the laser output time is, the larger the hole diameter will be.

(2) Laser OFF time

Sets the laser OFF time after a laser emission.

◆ Position setting

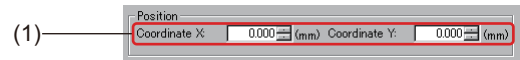

(1) Coordinate X/Coordinate Y

Sets coordinate X and coordinate Y of the fixed point.

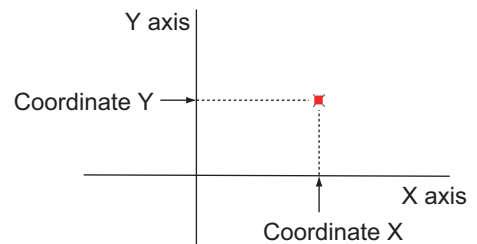

◆ Repeat setting

The settings are the same as those of the [Text] blocks.



Reference

- "◆ Repeat setting (page 2-28)"

● [Laser/Scan] tab

◆ Laser setting

The settings are the same as the [Basic] for the [Text] blocks. (Note, however, that [Processing speed] does not apply.)

The greater the laser power is, the larger the hole diameter will be.

Reference

- "◆ Basic (page 2-29)"
-

◆ Scan setting

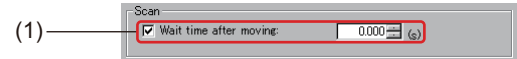

(1) Wait time after moving

When multiple fixed points are set, sets the wait time until when the marking of the next fixed point is started after when one fixed point is marked.

Additional Information

- The laser and scanning settings are usually set through the [Laser/Scan] tab in the [Common setting] and used as the common settings for all marking data. (Refer to "2.7 Common Setting (page 2-108)"). Set individual settings through the [Laser/Scan] tab in the properties for each block individually when it is necessary to set values that are different from the common setting. Excluding [Coefficient] and [Power], any items that are checked will become effective as an individual setting for that block which is independent from the [Common setting].
 - Click [Restore default value] to restore the default value. Furthermore, click [Save as default value] to save the settings on the screen as the default values. Note, however, that the above is not applicable to the [Position] settings in the [Form/Position] tab.
 - Click [Environment setting] on the menu bar, and then select [Reset to default value] to restore the factory default settings. (Refer to "6.5 Reset to default value (page 6-14)")
-

[Line] Block

The procedure for setting a [Line] block is explained using the following as an example.

■ Setting

Mark in a straight line from the start point specified for the work (Coordinate X: -10 mm/coordinate Y: -10 mm) to the end point (coordinate X: 10 mm/coordinate Y: 10 mm).

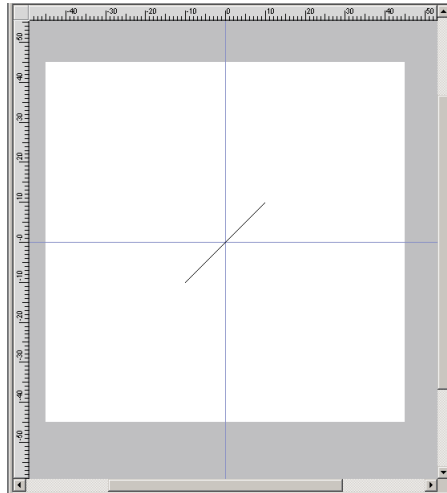

■ Setting procedure

- 1 Click  on the block menu, or click [Insert] on the menu bar and then select [Line]. [Straight line property] is displayed.

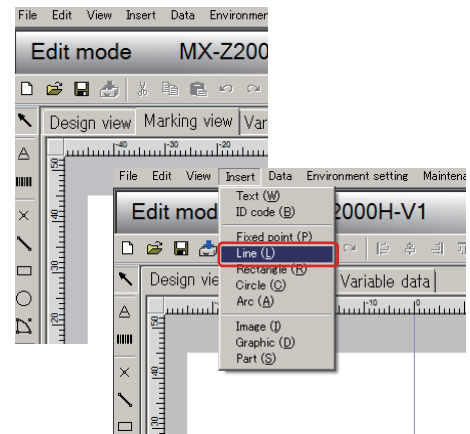

- 2 Draw a straight line on the sheet with the mouse.

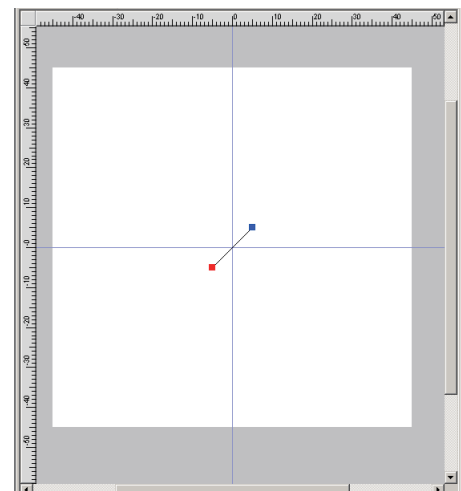

3 Select the [Form/Position] tab and set the following items.

<Form>

- Line : Solid line

<Position>

- Starting point X/Starting point Y : -10 mm/-10 mm
- End point X/End point Y : 10 mm/10 mm

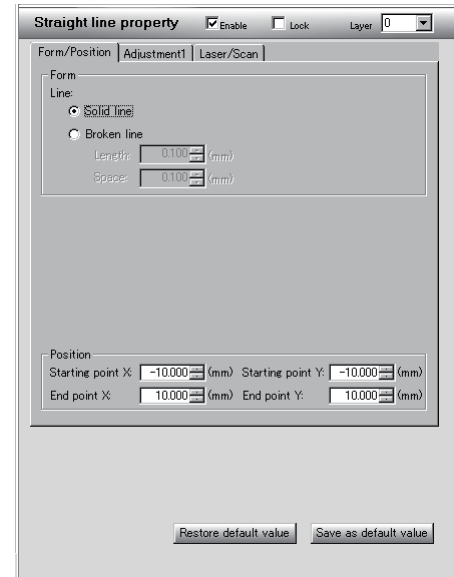

4 Click a blank area outside of the block on the sheet to confirm in the block.

The straight line is set based on the conditions specified for the sheet.

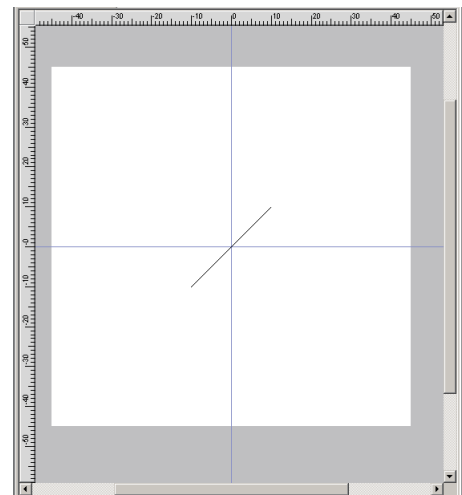

■ [Straight line property] setting items

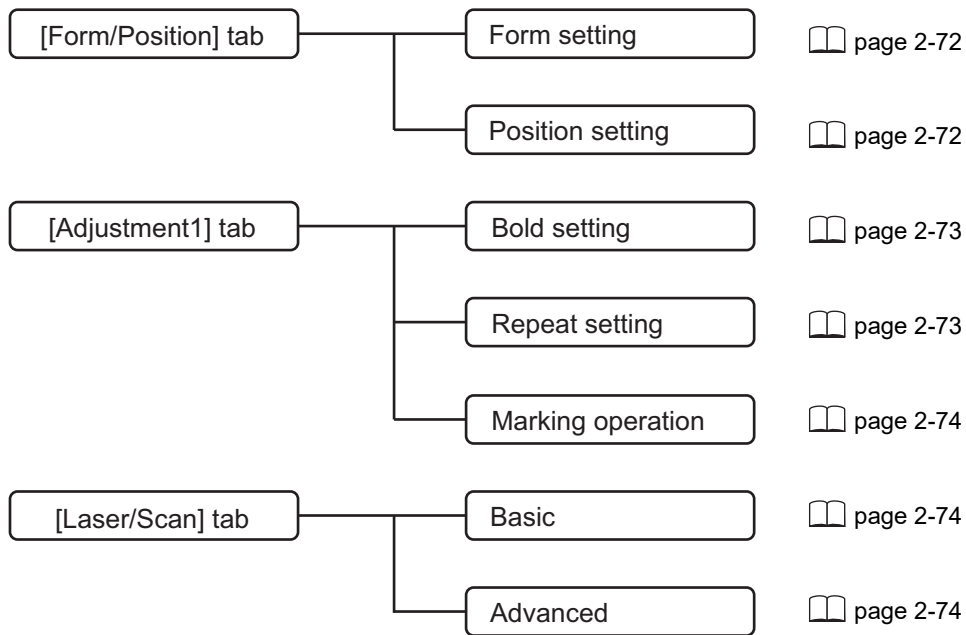

● [Form/Position] tab

◆ Form setting

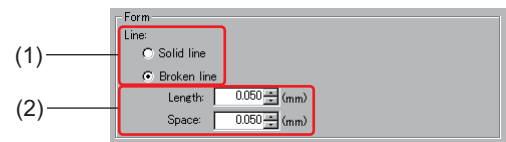

(1) Line

Selects the line type of the straight line.

- Solid line: A solid line is marked.
- Broken line: A broken line is marked.

Solid line

Broken line
Solid line length Space length

(2) Length/Space

If the “Broken line” is selected in “(1) Line,” sets the solid line length and the space length.

◆ Position setting

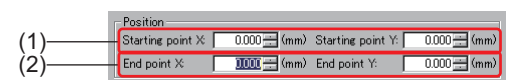

(1) Starting point X/Starting point Y

Sets coordinate X and coordinate Y of the start point of the straight line.

(2) End point X/End point Y

Sets coordinate X and coordinate Y of the end point of the straight line.

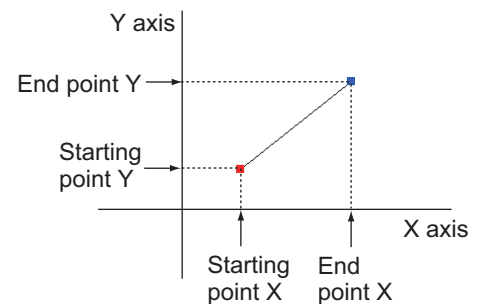

● [Adjustment1] tab

◆ Bold setting

Formats the straight line to bold.

Several lines are placed at equal intervals surrounding a single line to format the line to bold.

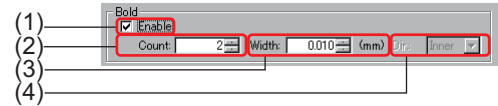

- Without formatting to bold



- Format to bold with 6 lines and line width of 1 mm

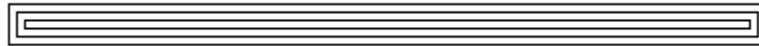

(1) Enable

This check box is selected to enable the bold formatting of the line.

(2) Count

Sets how many lines are to be used to format the text to bold.

(3) Width

Sets the bold line width (the distance between the outermost lines).

(4) Dir.

Set the marking start position when formatting the text to bold (setting the "(2) Count" to 3 or more).

- Inner: Marking is started from the inside of the straight line.
- Outer: Marking is started from the outside of the straight line.



Additional Information

If broken line is set as the line type, the space length will be narrower than the setting if the line is formatted to bold.

Without formatting to bold — — — — —

Formatting to bold 

◆ Repeat setting

The settings are the same as those of the [Text] blocks.



Reference

- "◆ Repeat setting (page 2-28)"

◆ Curve surface correction

The settings are the same as those of the [Text] blocks.



Reference

- "◆ Curve surface correction (page 2-28)"

◆ Marking operation

The settings are the same as those of the [Text] blocks.



Reference

- "◆ Marking operation (page 2-28)"
-

● [Laser/Scan] tab

◆ Basic

The settings are the same as those of the [Text] blocks.



Reference

- "◆ Basic (page 2-29)"
-

◆ Advanced

The settings are the same as those of the [Text] blocks.



Reference

- "◆ Advanced (page 2-30)"
-



Additional Information

- The laser and scanning settings are usually set through the [Laser/Scan] tab in the [Common setting] and used as the common settings for all marking data. (Refer to "2.7 Common Setting (page 2-108)"). Set individual settings through the [Laser/Scan] tab in the properties for each block individually when it is necessary to set values that are different from the common setting. Excluding [Coefficient] and [Power], any items that are checked will become effective as an individual setting for that block which is independent from the [Common setting].
 - Click [Restore default value] to restore the default value. Furthermore, click [Save as default value] to save the settings on the screen as the default values. Note, however, that the above is not applicable to the [Position] settings in the [Form/Position] tab.
 - Click [Environment setting] on the menu bar, and then select [Reset to default value] to restore the factory default settings. (Refer to "6.5 Reset to default value (page 6-14)")
-

[Rectangle] Block

The procedure for setting a [Rectangle] block is explained using the following as an example.

■ Setting

Mark a rectangle shape of the width of 40 mm and the height of 30 mm starting from the start point specified for the work (Coordinate X: -20 mm/coordinate Y: -15 mm).

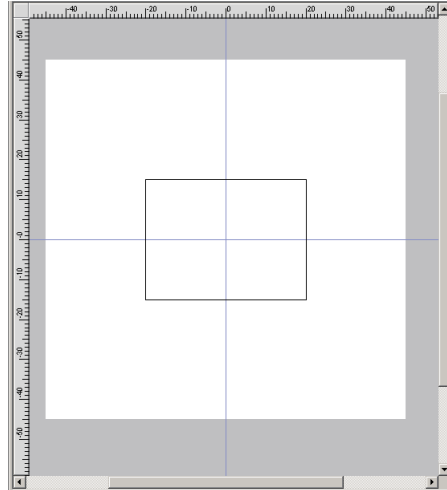

■ Setting procedure

- 1 Click  on the block menu, or click [Insert] on the menu bar and then select [Rectangle].
[Rectangle property] is displayed.

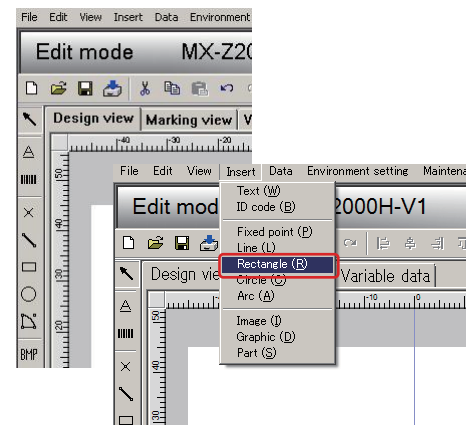

- 2 Draw a rectangle on the sheet with the mouse.

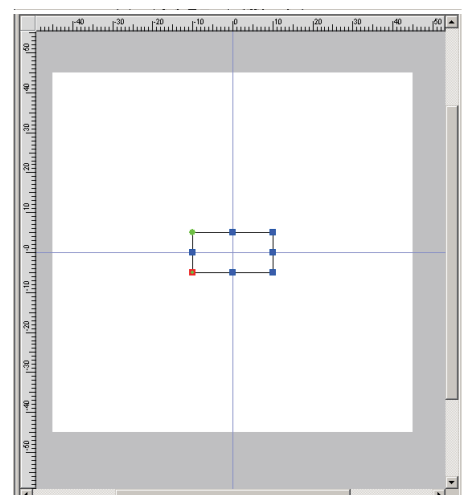

3 Select the [Form/Position] tab and set the following items.

<Form>

- Line : Solid line

<Position>

- Starting point X/Starting point Y : -20 mm/-15 mm
- Width/Height : 40 mm/30 mm

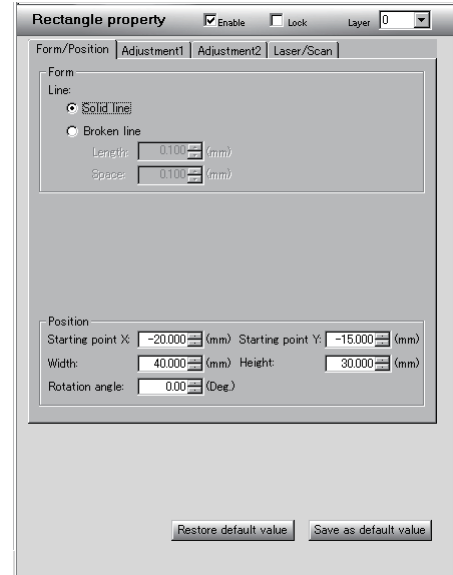

4 Click a blank area outside of the block on the sheet to confirm in the block.

The rectangle is set based on the conditions specified for the sheet.

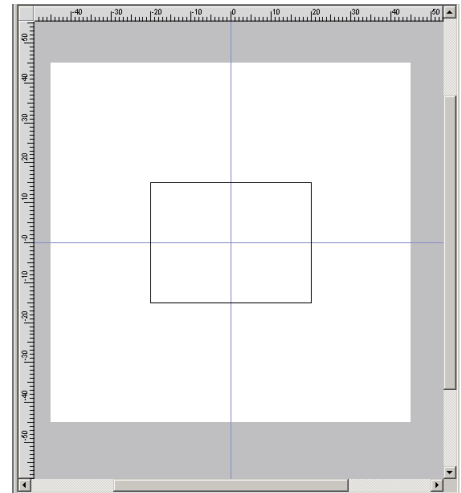

■ [Rectangle property] setting items

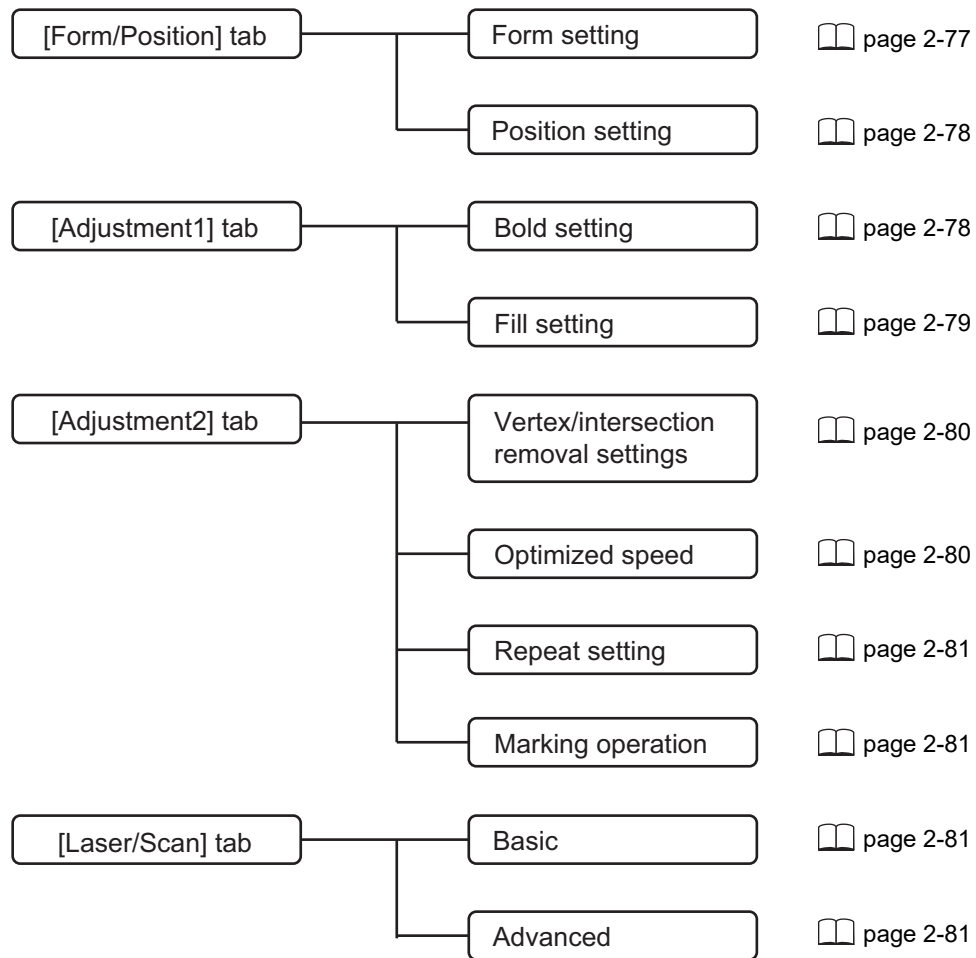

■ Setting

● [Form/Position] tab

◆ Form setting

The settings are the same as those of the [Line] blocks.

📖 Reference

- "◆ Form setting (page 2-72)"

◆ **Position setting**

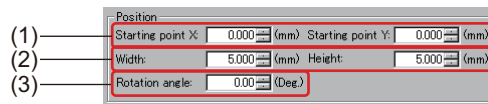

(1) Starting point X/Starting point Y
Sets coordinate X and coordinate Y of the start point (reference point) of the rectangle.

(2) Width/Height
Sets the width and the height of the rectangle.

(3) Rotation angle
Sets the rotation angle of the rectangle against the X-axis.
The code is rotated to the left at the specified angle.

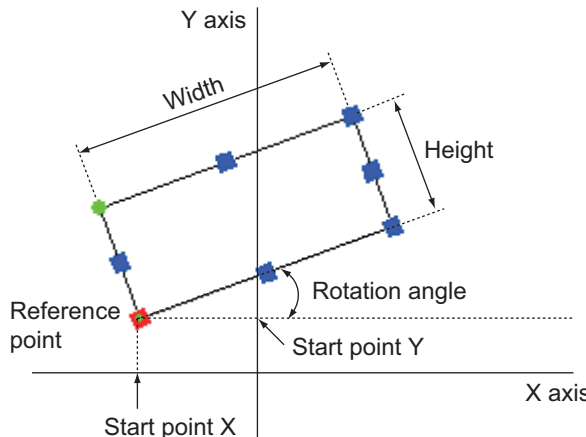

● **[Adjustment1] tab**

◆ **Bold setting**

Formats the rectangle to bold.
Several lines are placed at equal intervals surrounding a single line to format the line to bold.

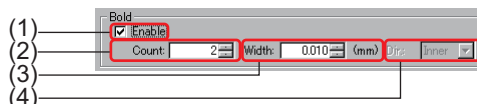

(1) Enable
This check box is selected to enable the bold formatting of the rectangle.

(2) Count
Sets how many lines are to be used to format the text to bold.

(3) Width
Sets the bold line width (the distance between the outermost lines).

(4) Dir.
Set the marking start position when formatting the text to bold (setting the “(2) Count” to 3 or more).

- Inner: Marking is started from the inside of the rectangle.
- Outer: Marking is started from the outside of the rectangle.



Additional Information

- If the bold setting is applied, the next paragraph, “Fill setting,” will be disabled.
- If broken line is set as the line type, the space length will be narrower than the setting if the line is formatted to bold.



Reference

- "◆ Bold setting (page 2-73)"

◆ Fill setting

Sets the fill method when filling the rectangle. The setting is enabled only when the line type is set to solid line.

(1) Enable

This check box is selected to enable the rectangle fill setting.

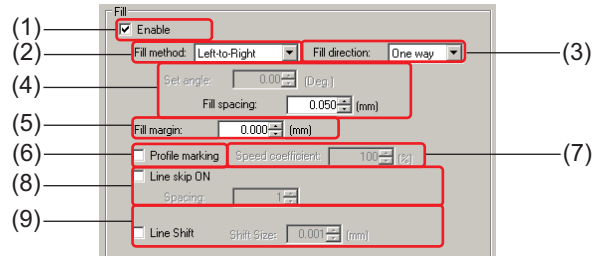

Additional Information

When the fill setting is selected, the previous item, "Bold setting," will be disabled.

(2) Fill method

Selects one of the following as the fill method.

Item	Description
Left-to-Right	Fills in the lateral direction from left to right at the fill spacing set in "(4) Set angle/Fill spacing."
Right-to-Left	Fills in the lateral direction from right to left at the fill spacing set in "(4) Set angle/Fill spacing."
Top-to-Bottom	Fills in the vertical direction from bottom to top at the fill spacing set in "(4) Set angle/Fill spacing."
Bottom-to-Top	Fills in the vertical direction from top to bottom at the fill spacing set in "(4) Set angle/Fill spacing."
Set	Fills at the fill angle and spacing set in "(4) Set angle/Fill spacing."

(3) Fill direction

Sets either of the following:

- Round trip: Fills both directions.
- One way: Fills one direction.

"Round trip" is selected to shorten the marking time.

(4) Set angle/Fill spacing

When "Set" is selected in "(2) Fill method," sets the angle in [Set angle], and the spacing between fill lines in [Fill spacing].

When "Left-to-Right", "Right-to-Left", "Top-to-Bottom", or "Bottom-to-Top" is selected in "(2) Fill method," set the spacing between fill lines in [Fill spacing].

(5) Fill margin

Sets the spacing (margin) between the rectangle border and the fill lines.

(6) Profile marking

This check box is selected to mark the rectangle borders when filling.

(7) Speed coefficient

The speed to mark the border can be set individually.

The speed is calculated by multiplying the processing speed or the moving speed by a coefficient.

Additional Information

When the processing speed exceeds 12000 mm/s due to the set speed coefficient, the border is marked at 12000 mm/s.

(8) Line skip ON/Spacing

This check box is selected to enable line skip for fill (skipping every few lines to avoid heat effects) and to set the spacing between the lines (at every how many line the text should be filled).

(9) Line Shift/Shift Size

The processing laser is not emitted continuously, but in an intermittent pulse. Because of this, when doing filling work, thin even lines (markings) can be made based on the laser pulse width, frequency and processing speed. When it is better for these markings not to stand out, check [Line Shift] to enable this function. [Shift Size] sets the amount of offset (mm) between the starting position for the outward scan and the ending position for the return scan. When this function is enabled, the exposure area becomes shorter based on the amount set through the [Shift Size] for the fill starting or ending position.

• Normal filling

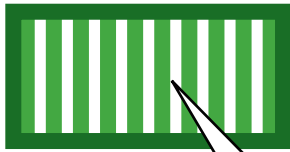

Markings stand out, as there are a gap between laser exposure points at the same coordinates

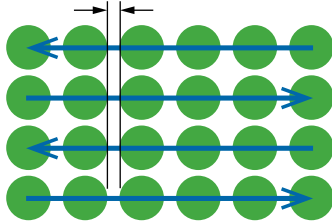

• When [Line Shift] is enabled



Shift Size (outward scan starting position)

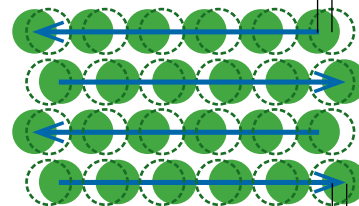

Shift Size (return scan ending position)

← Laser scanning direction

● Laser exposure point

● **[Adjustment2] tab**

◆ **Vertex/intersection removal settings**

The settings are the same as those of the [Text] blocks.



Reference

- "◆ Vertex/intersection removal settings (page 2-27)"

◆ **Optimized speed**

The settings are the same as those of the [Text] blocks.



Reference

- "◆ Optimized speed (page 2-27)"

◆ Repeat setting

The settings are the same as those of the [Text] blocks.

Reference

- "◆ Repeat setting (page 2-28)"
-

◆ Curve surface correction

The settings are the same as those of the [Text] blocks.

Reference

- "◆ Curve surface correction (page 2-28)"
-

◆ Marking operation

The settings are the same as those of the [Text] blocks.

Reference

- "◆ Marking operation (page 2-28)"
-

● [Laser/Scan] tab

◆ Basic

The settings are the same as those of the [Text] blocks.

Reference

- "◆ Basic (page 2-29)"
-

◆ Advanced

The settings are the same as those of the [Text] blocks.

Reference

- "◆ Advanced (page 2-30)"
-



Additional Information

- The laser and scanning settings are usually set through the [Laser/Scan] tab in the [Common setting] and used as the common settings for all marking data. (Refer to "2.7 Common Setting (page 2-108)"). Set individual settings through the [Laser/Scan] tab in the properties for each block individually when it is necessary to set values that are different from the common setting. Excluding [Coefficient] and [Power], any items that are checked will become effective as an individual setting for that block which is independent from the [Common setting].
 - Click [Restore default value] to restore the default value. Furthermore, click [Save as default value] to save the settings on the screen as the default values. Note, however, that the above is not applicable to the [Position] settings in the [Form/Position] tab.
 - Click [Environment setting] on the menu bar, and then select [Reset to default value] to restore the factory default settings. (Refer to "6.5 Reset to default value (page 6-14)")
-

[Circle] Block

The procedure for setting a [Circle] block is explained using the following as an example.

■ Setting

With the work center set as the reference, mark a 20-mm radius circular shape.

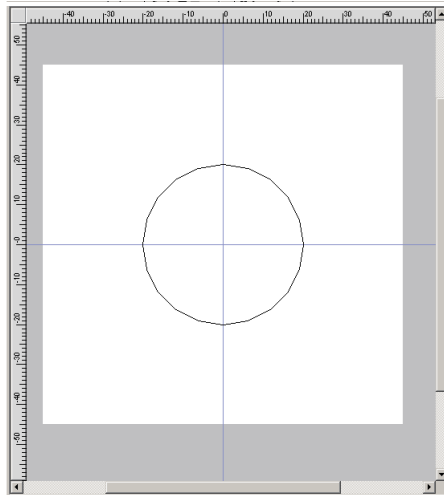

■ Setting procedure

- 1 Click  on the block menu, or click [Insert] on the menu bar and then select [Circle]. [Circle property] is displayed.

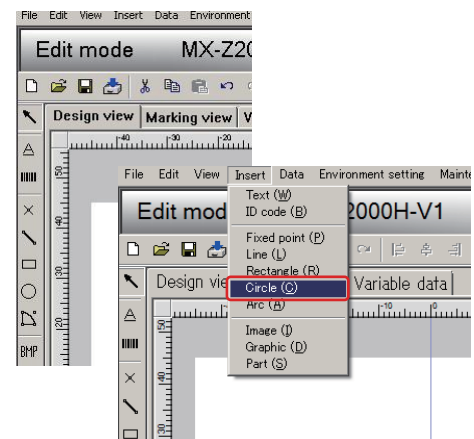

- 2 Draw a circle on the sheet with the mouse.

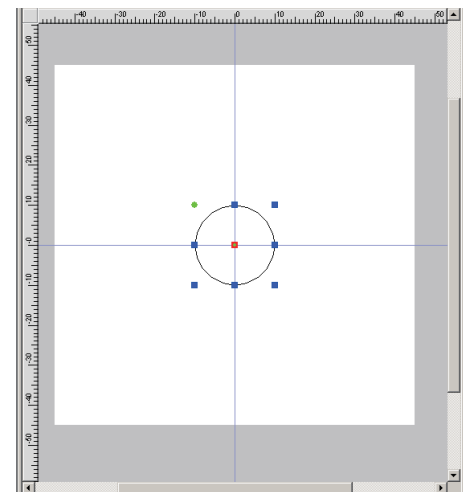

3 Select the [Form/Position] tab and set the following items.

<Form>

- Line : Solid line
- Divided by : 20

<Position>

- Coordinate X/Coordinate Y : 0 mm/0 mm
- Radius X/Radius Y : 20 mm/20 mm

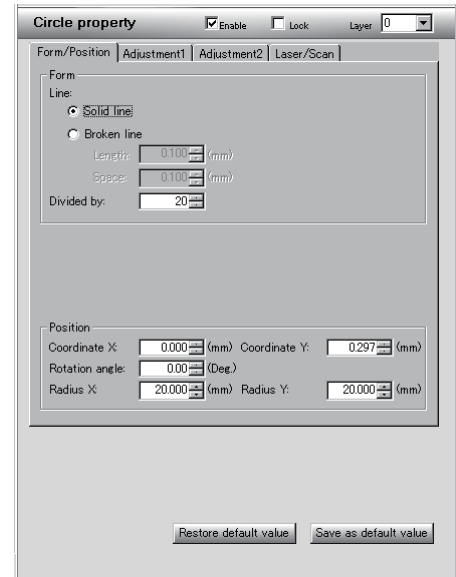

4 Click a blank area outside of the block on the sheet to confirm in the block.

The circle is set based on the conditions specified for the sheet.

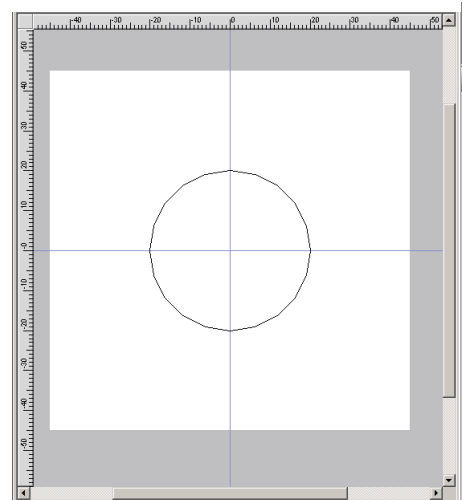

■ [Circle property] setting items

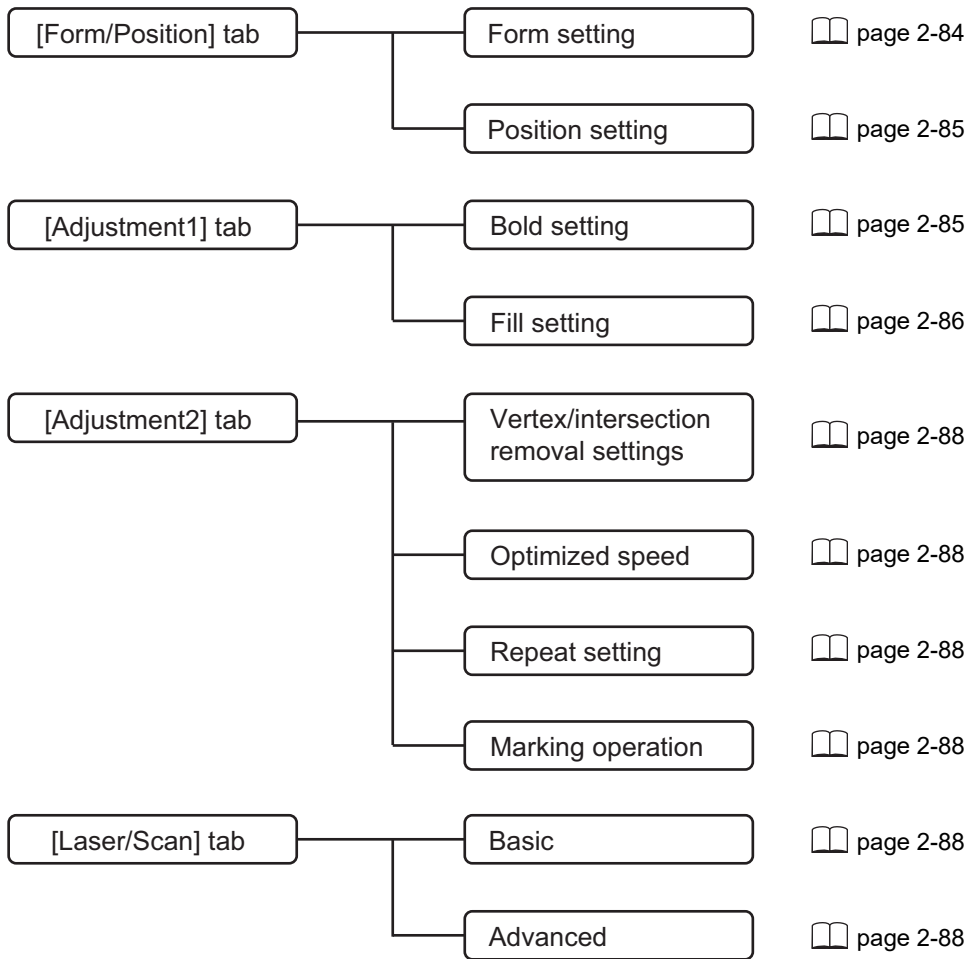

● [Form/Position] tab

◆ Form setting

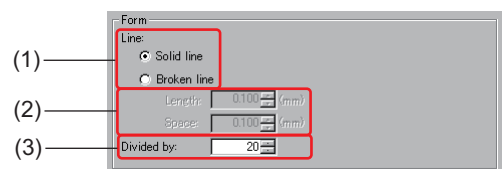

(1) Line

Selects the line type of the circle.

- Solid line: Laser is emitted in solid lines.
- Broken line: Laser is emitted in broken lines.

Solid line

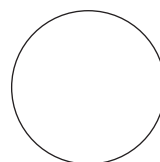

Broken line

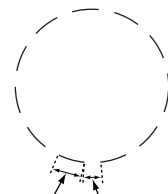

Solid line length

Space length

(2) Length/Space

If the [Broken line] is selected in “(1) Line,” sets the solid line length and the space length.

(3) Divided by

Sets by how many lines the circle is to be divided.
The greater the number of lines is, the closer to a perfect circle it will be.

• Divided by: 15

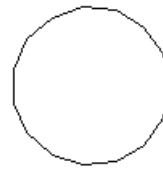

• Divided by: 10

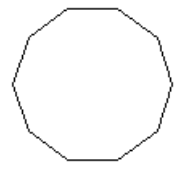
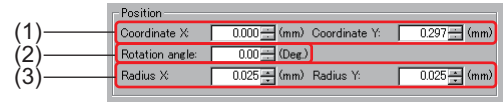
**◆ Position setting****(1) Coordinate X/Coordinate Y**

Sets coordinate X and coordinate Y of the center (reference point) of the circle.

(2) Rotation angle

Sets the rotation angle of the circle against the X-axis.
The circle is rotated to the left at the specified angle with its center set as the basis.

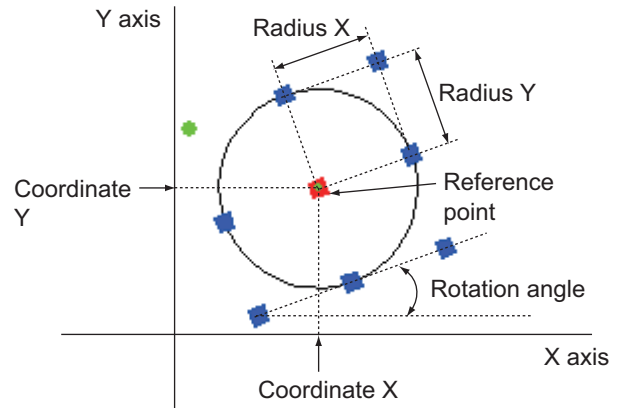
**(3) Radius X/Radius Y**

Sets the radius X and radius Y of the circle.

● [Adjustment1] tab**◆ Bold setting**

Formats the circle to bold.
Several lines are placed at equal intervals surrounding a single line to format the line to bold.

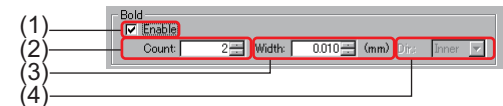
**(1) Enable**

This check box is selected to enable the bold formatting of the circle.

(2) Count

Sets how many lines are to be used to format the text to bold.

(3) Width

Sets the bold line width (the distance between the outermost lines).

(4) Dir.

Set the marking start position when formatting the text to bold (setting the “(2) Count” to 3 or more).

- Inner: Marking is started from the inside of the rectangle.
- Outer: Marking is started from the outside of the rectangle.



Additional Information

- If the bold setting is applied, the next paragraph, “Fill setting,” will be disabled.
- If broken line is set as the line type, the space length will be narrower than the setting if the line is formatted to bold.



Reference

- "♦ Bold setting (page 2-73)"

♦ Fill setting

Sets the fill method when filling the circle.
The setting is enabled only when the line type is set to solid line.

(1) Enable

This check box is selected to enable the circle fill setting.

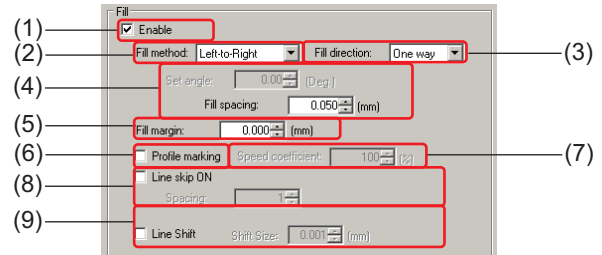

Additional Information

When the fill setting is selected, the previous item, “Bold setting,” will be disabled.

(2) Fill method

Selects one of the following as the fill method.

Item	Description
Left-to-Right	Fills in the lateral direction from left to right at the fill spacing set in “(4) Set angle/Fill spacing.”
Right-to-Left	Fills in the lateral direction from right to left at the fill spacing set in “(4) Set angle/Fill spacing.”
Top-to-Bottom	Fills in the vertical direction from bottom to top at the fill spacing set in “(4) Set angle/Fill spacing.”
Bottom-to-Top	Fills in the vertical direction from top to bottom at the fill spacing set in “(4) Set angle/Fill spacing.”
Set	Fills at the fill angle and spacing set in “(4) Set angle/Fill spacing.”

(3) Fill direction

Sets either of the following:

- Round trip: Fills both directions.
- One way: Fills one direction.

“Round trip” is selected to shorten the marking time.

(4) Set angle/Fill spacing

When “Set” is selected in “(2) Fill method,” sets the angle in [Set angle], and the spacing between fill lines in [Fill spacing].

When “Left-to-Right”, “Right-to-Left”, “Top-to-Bottom”, or “Bottom-to-Top” is selected in “(2) Fill method,” set the spacing between fill lines in [Fill spacing].

(5) Fill margin

Sets the spacing (margin) between the circle border and the fill lines.

(6) Profile marking

This check box is selected to mark the circle borders when filling.

(7) Speed coefficient

The speed to mark the border can be set individually.

The speed is calculated by multiplying the processing speed or the moving speed by a coefficient.

**Additional Information**

When the processing speed exceeds 12000 mm/s due to the set speed coefficient, the border is marked at 12000 mm/s.

(8) Line skip ON/Spacing

This check box is selected to enable line skip for fill (skipping every few lines to avoid heat effects) and to set the spacing between the lines (at every how many line the text should be filled).

(9) Line Shift/Shift Size

The processing laser is not emitted continuously, but in an intermittent pulse. Because of this, when doing filling work, thin even lines (markings) can be made based on the laser pulse width, frequency and processing speed. When it is better for these markings not to stand out, check [Line Shift] to enable this function. [Shift Size] sets the amount of offset (mm) between the starting position for the outward scan and the ending position for the return scan.

When this function is enabled, the exposure area becomes shorter based on the amount set through the [Shift Size] for the fill starting or ending position.

• Normal filling

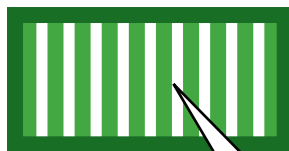

Markings stand out, as there is a gap between laser exposure points at the same coordinates

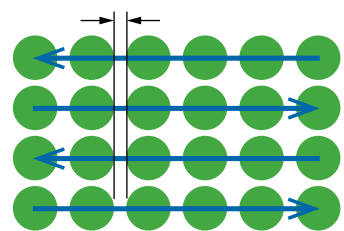

↔ Laser scanning direction

• When [Line Shift] is enabled



Shift Size
(outward scan starting position)

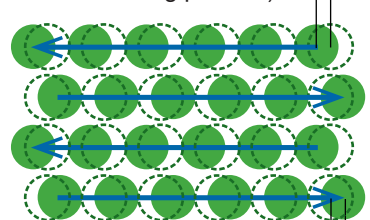

Shift Size
(return scan ending position)

● Laser exposure point

● [Adjustment2] tab

◆ Vertex/intersection removal settings

The settings are the same as those of the [Text] blocks.



Reference

- "◆ Vertex/intersection removal settings (page 2-27)"
-

◆ Optimized speed

The settings are the same as those of the [Text] blocks.



Reference

- "◆ Optimized speed (page 2-27)"
-

◆ Repeat setting

The settings are the same as those of the [Text] blocks.



Reference

- "◆ Repeat setting (page 2-28)"
-

◆ Curve surface correction

The settings are the same as those of the [Text] blocks.



Reference

- "◆ Curve surface correction (page 2-28)"
-

◆ Marking operation

The settings are the same as those of the [Text] blocks.



Reference

- "◆ Marking operation (page 2-28)"
-

● [Laser/Scan] tab

◆ Basic

The settings are the same as those of the [Text] blocks.



Reference

- "◆ Basic (page 2-29)"
-

◆ Advanced

The settings are the same as those of the [Text] blocks.



Reference

- "◆ Advanced (page 2-30)"
-



Additional Information

2

- The laser and scanning settings are usually set through the [Laser/Scan] tab in the [Common setting] and used as the common settings for all marking data. (Refer to "2.7 Common Setting (page 2-108)"). Set individual settings through the [Laser/Scan] tab in the properties for each block individually when it is necessary to set values that are different from the common setting. Excluding [Coefficient] and [Power], any items that are checked will become effective as an individual setting for that block which is independent from the [Common setting].
 - Click [Restore default value] to restore the default value. Furthermore, click [Save as default value] to save the settings on the screen as the default values. Note, however, that the above is not applicable to the [Position] settings in the [Form/Position] tab.
 - Click [Environment setting] on the menu bar, and then select [Reset to default value] to restore the factory default settings. (Refer to "6.5 Reset to default value (page 6-14)")
-

[Arc] Block

The procedure for setting an [Arc] block is explained using the following as an example.

■ Setting

With the work center set as the reference, mark an arc shape of a 20 mm radius with the starting angle of 30 degree and the opening angle of 120 degree.

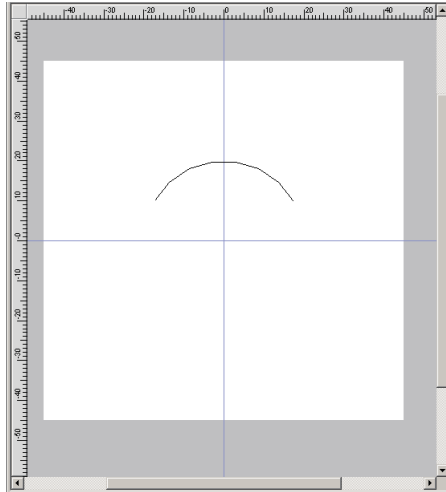

■ Setting procedure

- 1 Click  on the block menu, or click [Insert] on the menu bar and then select [Arc]. [Arc property] is displayed.

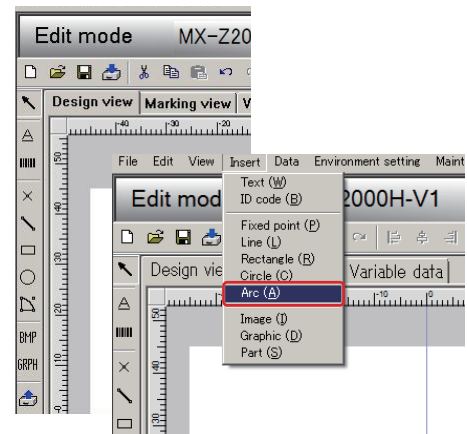

- 2 Draw an arc on the sheet with the mouse.

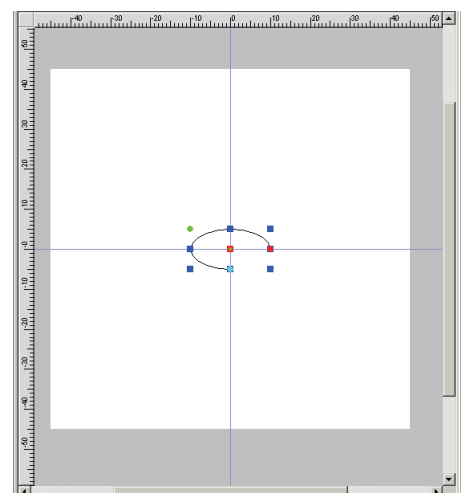

3 Select the [Form/Position] tab and set the following items.

<Form>

- Line : Solid line
- Divided by : 20

<Position>

- Coordinate X/Coordinate Y : 0 mm/0 mm
- Radius X/Radius Y : 20 mm/20 mm
- Start angle/Open angle : 30° /120°

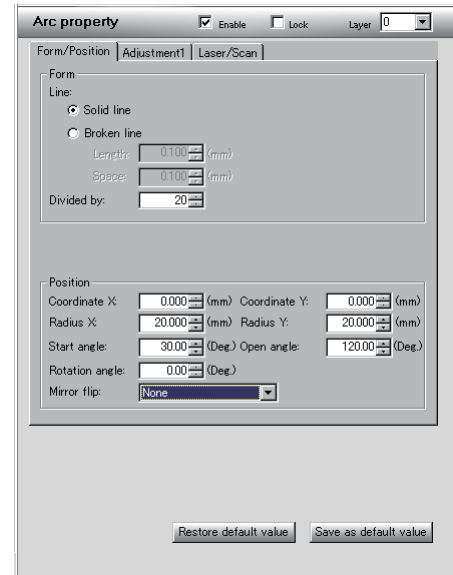

4 Click a blank area outside of the block on the sheet to confirm in the block.

The arc is set based on the conditions specified for the sheet.

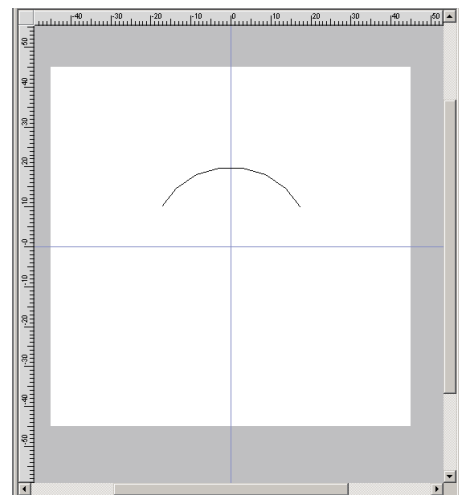

■ [Arc property] setting items

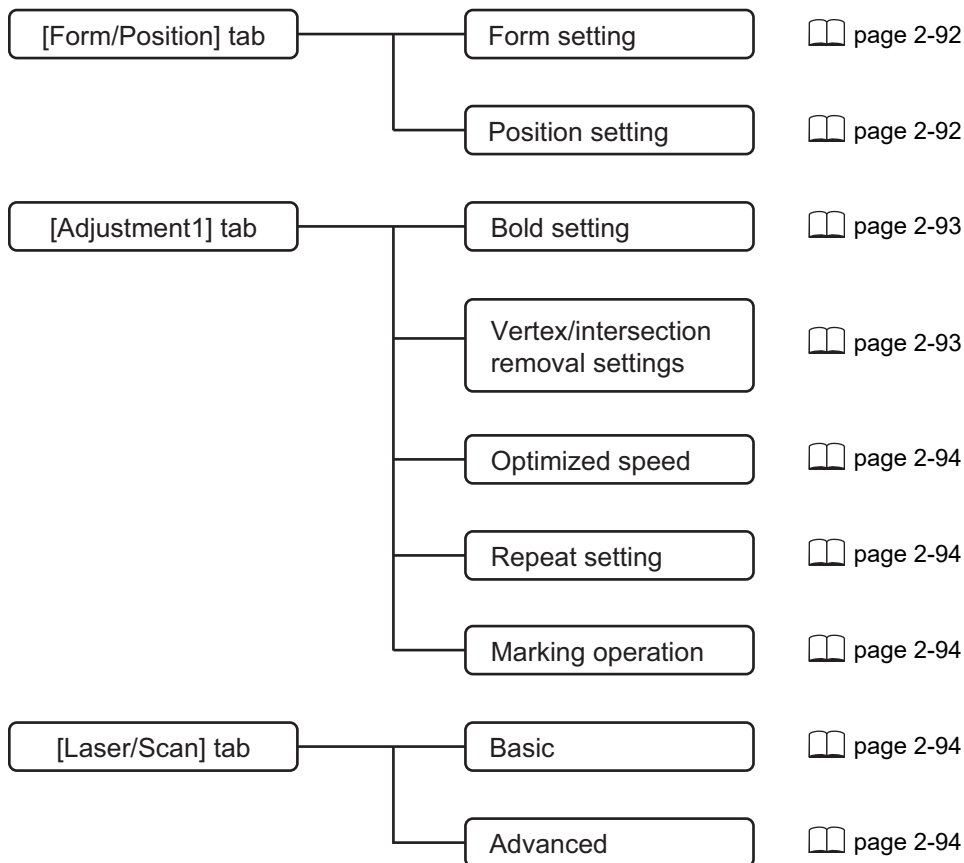

● [Form/Position] tab

◆ Form setting

The settings are the same as those of the [Circle] blocks.

📖 Reference

- "◆ Form setting (page 2-84)"

◆ Position setting

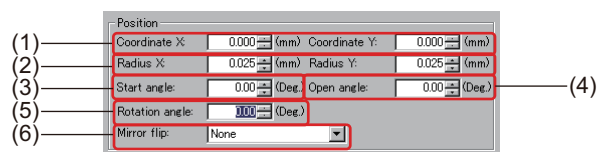

(1) Coordinate X/Coordinate Y

Sets coordinate X and coordinate Y of the center (reference point) of the arc.

(2) Radius X/Radius Y

Sets the radius X and radius Y of the arc.

(3) Start angle

Sets the angle (start angle) against home for the start point of the arc.

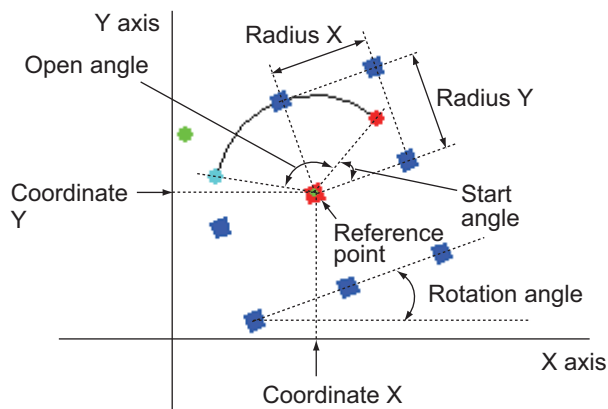

(4) Open angle

Sets the angle (open angle) against the home from the start point to the end point of the arc.

(5) Rotation angle

Sets the rotation angle of the arc against the X-axis.

The circle is rotated to the left at the specified angle with its center set as the basis.

(6) Mirror flip

This is set to flip the arc.

- **[Adjustment1] tab**

- ◆ **Bold setting**

Formats the arc to bold.

Several lines are placed at equal intervals surrounding a single line to format the line to bold.

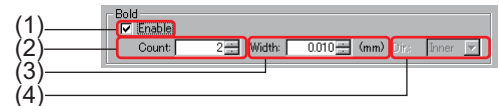

- (1) Enable**

This check box is selected to enable the bold formatting of the arc.

- (2) Count**

Sets how many lines are to be used to format the text to bold.

- (3) Width**

Sets the bold line width (the distance between the outermost lines).

- (4) Dir.**

Set the marking start position when formatting the text to bold (setting the "(2) Count" to 3 or more).

- Inner: Marking is started from the inside of the rectangle.
- Outer: Marking is started from the outside of the rectangle.



Additional Information

If broken line is set as the line type, the space length will be narrower than the setting if the line is formatted to bold.



Reference

- "◆ Bold setting (page 2-73)"

- ◆ **Vertex/intersection removal settings**

The settings are the same as those of the [Text] blocks.



Reference

- "◆ Vertex/intersection removal settings (page 2-27)"

◆ Optimized speed

The settings are the same as those of the [Text] blocks.



Reference

- "◆ Optimized speed (page 2-27)"
-

◆ Repeat setting

The settings are the same as those of the [Text] blocks.



Reference

- "◆ Repeat setting (page 2-28)"
-

◆ Curve surface correction

The settings are the same as those of the [Text] blocks.



Reference

- "◆ Curve surface correction (page 2-28)"
-

◆ Marking operation

The settings are the same as those of the [Text] blocks.



Reference

- "◆ Marking operation (page 2-28)"
-

● [Laser/Scan] tab

◆ Basic

The settings are the same as those of the [Text] blocks.



Reference

- "◆ Basic (page 2-29)"
-

◆ Advanced

The settings are the same as those of the [Text] blocks.



Reference

- "◆ Advanced (page 2-30)"
-



Additional Information

2

- The laser and scanning settings are usually set through the [Laser/Scan] tab in the [Common setting] and used as the common settings for all marking data. (Refer to "2.7 Common Setting (page 2-108)"). Set individual settings through the [Laser/Scan] tab in the properties for each block individually when it is necessary to set values that are different from the common setting. Excluding [Coefficient] and [Power], any items that are checked will become effective as an individual setting for that block which is independent from the [Common setting].
 - Click [Restore default value] to restore the default value. Furthermore, click [Save as default value] to save the settings on the screen as the default values. Note, however, that the above is not applicable to the [Position] settings in the [Form/Position] tab.
 - Click [Environment setting] on the menu bar, and then select [Reset to default value] to restore the factory default settings. (Refer to "6.5 Reset to default value (page 6-14)")
-

[Image] Block

■ **Setting procedure**

- 1 Click **BMP** on the block menu, or click **[Insert]** on the menu bar and then select **[Image]**.
[Image property] is displayed.

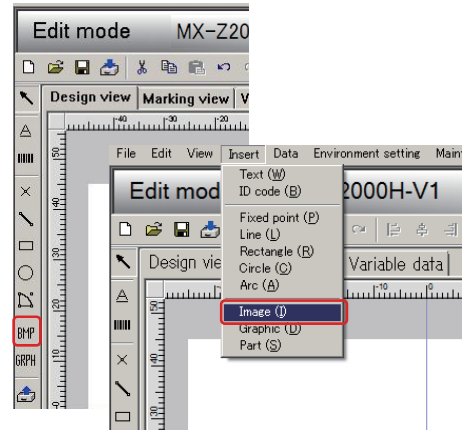

- 2 Click **[Edit]**.
The [Select data] dialog box is displayed.

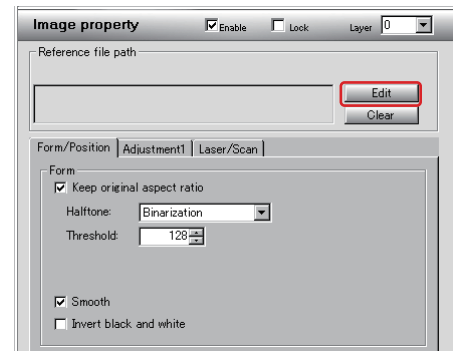

- 3 Select **[Select file]** and click **[OK]**.
All image files (BMP/JPEG/PNG formats) are displayed in the [Pick Image] dialog box.

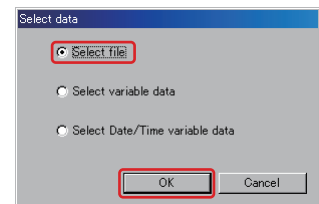

- 4 Select the image file to be marked and click **[Open]**.

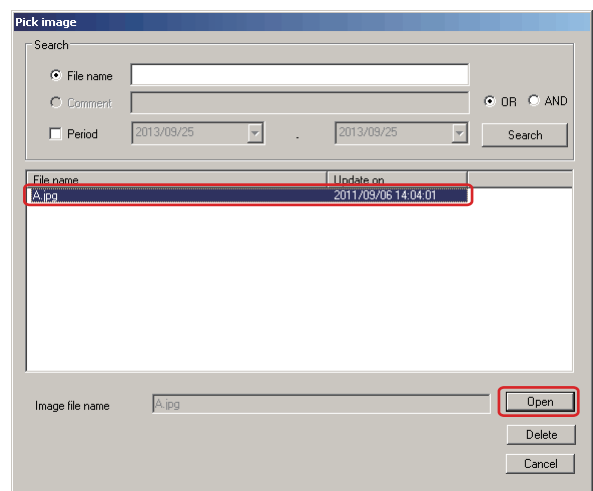

The content of the image file to be marked on the sheet is displayed, and the [Reference file path] displays the selected image file name.

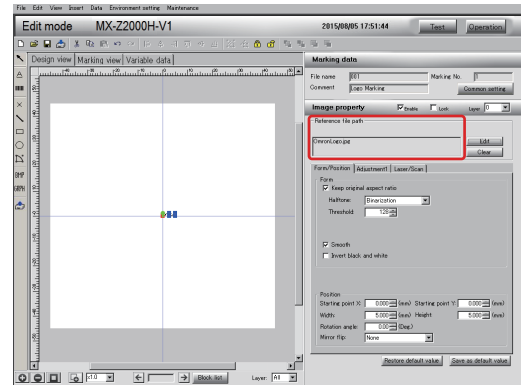

2



Additional Information

- Click [Clear] to clear the selected file name.
- With the [Pick Image] dialog box, you can search image file with the method described below.
 - Search with file name
 - Search with the date (period) of creation
 - Search with file name and the date (period) of creation

In the [Search] box, select the item that you want to use for the search from above, enter the search keyword and/or period, and then click [search].

You can specify OR and AND conditions. When specifying multiple search keywords, separate the keywords with a comma “,” or semicolon “;”.

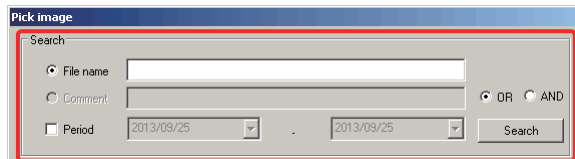

5 Specify the settings in [Image property].



Precautions for Correct Use

When the image block is set, the calculation time is affected depending on the marking data setting and screen operations may take longer than usual.

■ [Image property] setting items

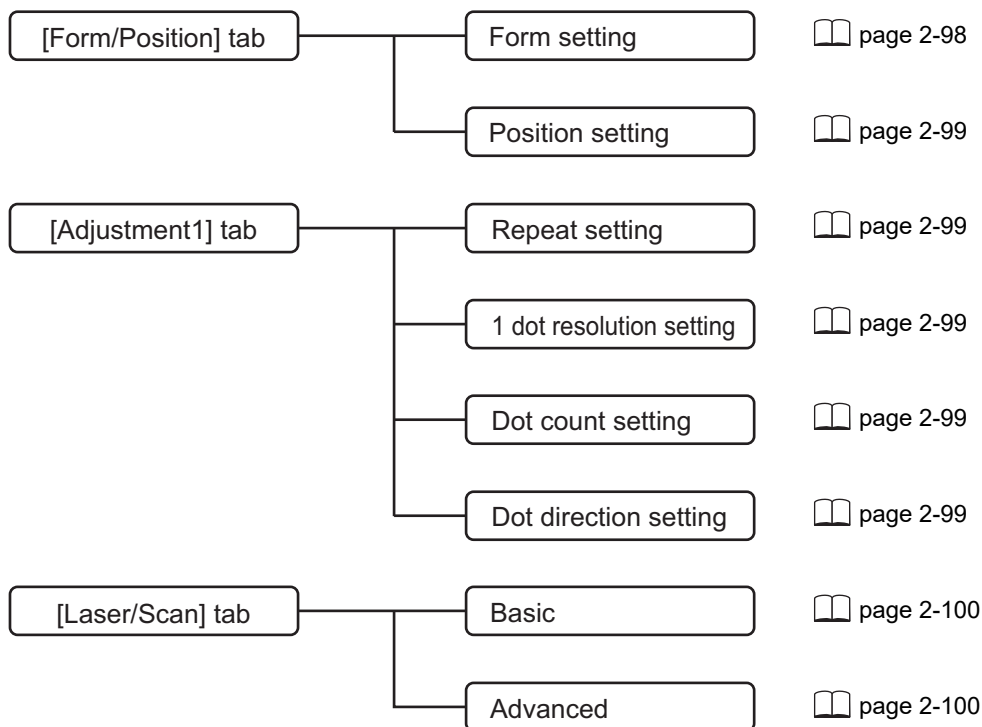

● [Form/Position] tab

◆ Form setting

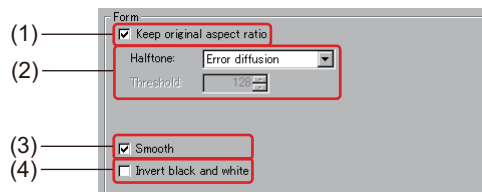

(1) Keep original aspect ratio

This check box is selected to load the image or enlarge/shrink the image while maintaining the original aspect ratio of the image.

When this is cleared, the aspect ratio is adjusted according to the setting range of the marking area.

(2) Halftone

Selects the halftone processing mode.

- Binarization
- Auto-binarization
- Random
- Error diffusion

When “Binarization” is selected, sets [Threshold] (the threshold that determines whether the pixels in the image are output in white or black).

The larger this value is, the greater the amount of black pixels will be.



Additional Information

“Halftone” is a method of expressing a color image or grayscale image in small black and white points (dots).

(3) Smooth

This check box is selected to smooth an image.

**Additional Information**

“Smoothing” is a method of removing noise in an image and/or averaging high-density changes in the pixels to create a smooth and easy-to-view image.

(4) Invert black and white

This check box is selected to invert black and white in the image.

◆ Position setting

The settings are the same as those of the [ID code] blocks.

**Reference**

- "◆ Position setting (page 2-56)"

● [Adjustment1] tab**◆ Repeat setting**

The settings are the same as those of the [Text] blocks.

**Reference**

- "◆ Repeat setting (page 2-28)"

◆ 1-dot resolution setting**(1) X-direction/Y-direction**

Sets the dot size.

The smaller the dots are, the cleaner the image will be. However, setting the input value to a value smaller than 0.050 mm will reduce the processing speed and could make correct marking impossible.

◆ Dot count setting**(1) Pixel dot Count**

Sets the number of dots per image pixel.

◆ Dot direction setting**(1) Direction**

Sets the direction to fill the dots in the image.

- Round trip: Fills both directions.
- One way: Fills one direction.

◆ Curve surface correction

This sets automatic correction for marking on curved surfaces, such as columns. The curve surface correction is always enabled for [Image] block.



Precautions for Correct Use

Place the block for which curve surface correction is performed within the layer diagram. Otherwise, the correction may not be performed properly or the block may not be displayed.

● [Laser/Scan] tab

◆ Basic

The settings are the same as those of the [Text] blocks.

However, this only applies when the frequency is set to a range from 10.0 kHz to 100.0 kHz.



Reference

- "◆ Basic (page 2-29)"
-

◆ Advanced

The settings are the same as those of the [Text] blocks.



Reference

- "◆ Advanced (page 2-30)"
-



Additional Information

- Image blocks will be printed by filling dots, so the drawing method and speed conditions will differ from standard printing.
 - The laser and scanning settings are usually set through the [Laser/Scan] tab in the [Common setting] and used as the common settings for all marking data. (Refer to "2.7 Common Setting (page 2-108)"). Set individual settings through the [Laser/Scan] tab in the properties for each block individually when it is necessary to set values that are different from the common setting. Excluding [Coefficient] and [Power], any items that are checked will become effective as an individual setting for that block which is independent from the [Common setting].
 - Click [Restore default value] to restore the default value. Furthermore, click [Save as default value] to save the settings on the screen as the default values. Note, however, that the above is not applicable to the [Position] settings in the [Form/Position] tab.
 - Click [Environment setting] on the menu bar, and then select [Reset to default value] to restore the factory default settings. (Refer to "6.5 Reset to default value (page 6-14)")
-

[Graphic] block

- 1 Click **GRPH** on the block menu, or click **[Insert]** on the menu bar and then select **[Graphic]**.
[Graphic property] is displayed.

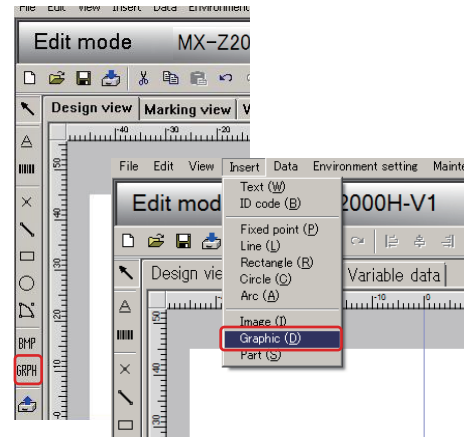

- 2 Click **[Edit]**.
The [Select data] dialog box is displayed.

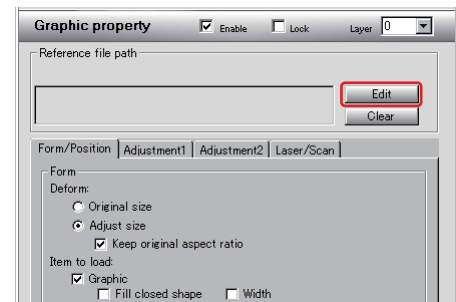

- 3 Select **[Select file]** and click **[OK]**.
All graphic files (DXF format) are displayed in the [Pick Graphic] dialog box.

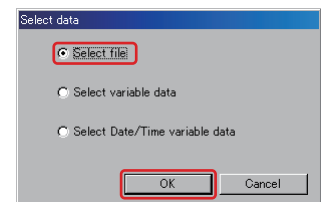

- 4 Select the graphic file to be marked, click **[Open]**.

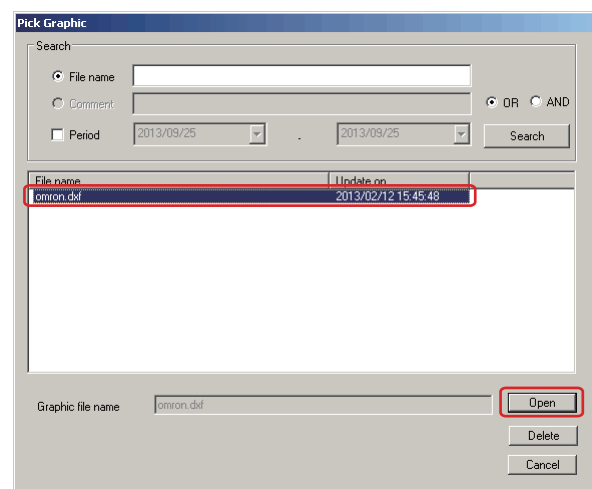

The content of the graphic file to be marked on the sheet is displayed, and the [Reference file path] displays the selected graphic file name.

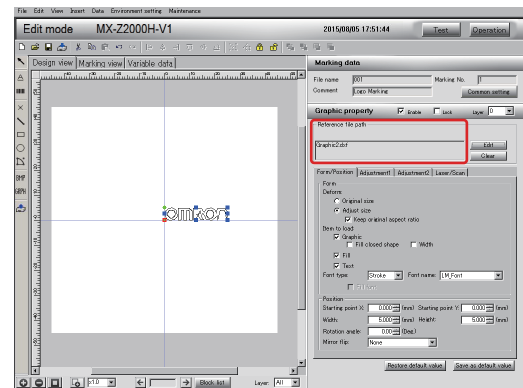

Precautions for Correct Use

- The DXF file cannot be read if it contains single-byte katakana.
- When the graphic block is set, the calculation time is affected depending on the marking data setting and screen operations may take longer than usual.

Additional Information

- Click [Clear] to clear the selected file name.
 - With the [Pick Graphic] dialog box, you can search graphic file with the method described below.
 - Search with file name
 - Search with the date (period) of creation
 - Search with file name and the date (period) of creation
- In the [Search] box, select the item that you want to use for the search from above, enter the search keyword and/or period, and then click [search].
You can specify OR and AND conditions. When specifying multiple search keywords, separate the keywords with a comma “,” or semicolon “;”.

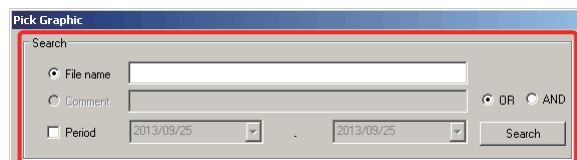

- The logo data (DXF format) to be loaded to the laser marker can be edited using the Font logo editor. (Refer to "Chapter 11 How to Use Font Logo Editor (page 11-1)")

5 Specify the settings in [Graphic property].

■ [Shape prop] setting items

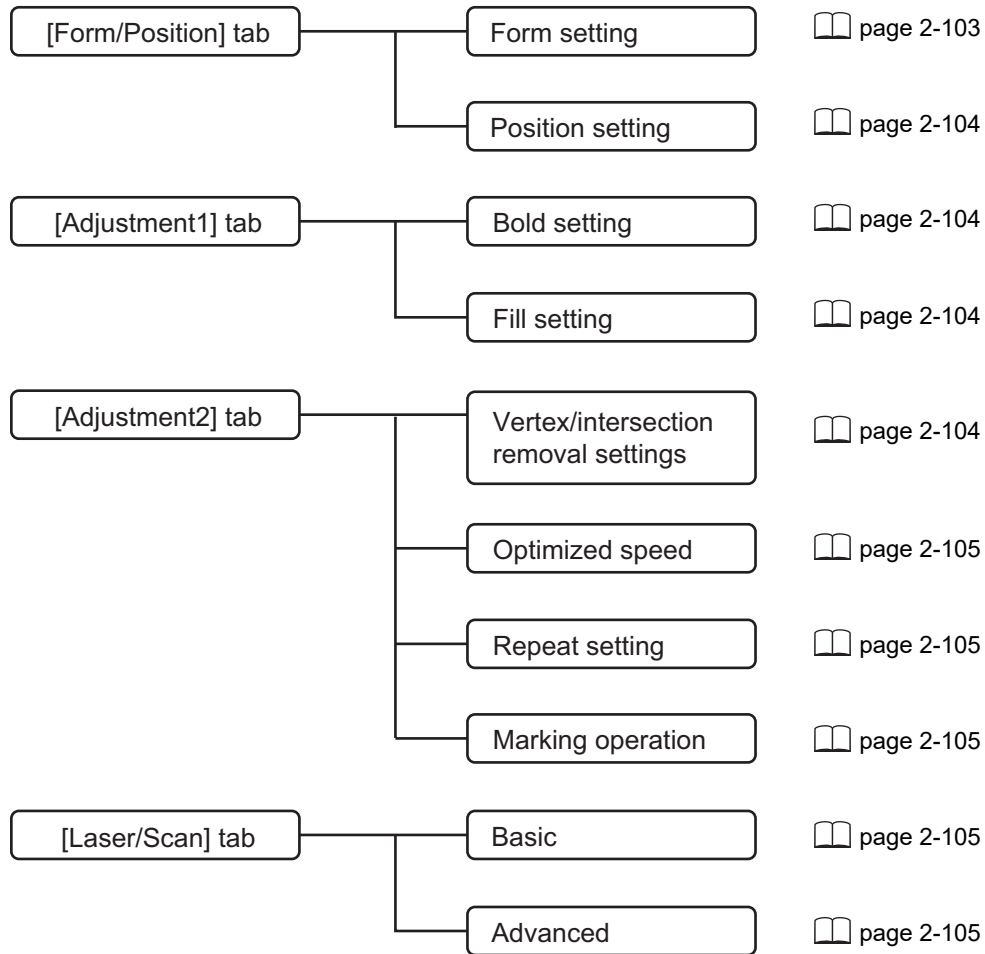

● [Form/Position] tab

◆ Form setting

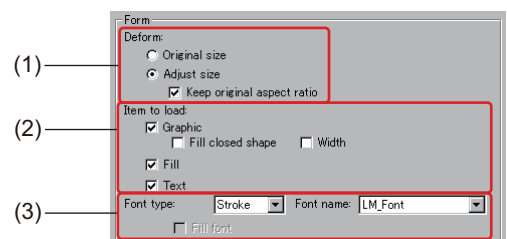

(1) Deform

Sets the method of loading a graphic file and to enlarge/shrink a graphic image.

- Original size: The graphic is loaded in the size of the data in the graphic file (original size).
- Adjust size: The graphic is loaded or enlarged/shrunk according to the marking area setting range.

To keep the actual aspect ratio of the graphic file when [Adjust size] is selected, the check box for [Keep original aspect ratio] is selected.

(2) Item to load

Selects the check box for the type of data in the graphic file to be loaded.

- Graphic
- Fill
- Text

The check box for [Fill closed shape] is selected to fill a closed graphic when [Graphic] is selected, or the check box for [Width] is selected to enable the line width value retained in the data. The [Fill closed shape] will become effective only for shapes made with polylines.

(3) Font

Sets the font type and font name for the text if the graphic file contains text data.

The check box for [Fill font] is selected to fill the text when True Type font is selected.

◆ Position setting

The settings are the same as those of the [Image] blocks.



Reference

- "◆ Position setting (page 2-92)"
-

● [Adjustment1] tab

◆ Bold setting

The settings are the same as those of the [Text] blocks.



Reference

- "◆ Bold setting (page 2-24)"
-

◆ Fill setting

The settings are the same as those of the [Text] blocks.



Reference

- "◆ Fill setting (page 2-25)"
-

● [Adjustment2] tab

◆ Vertex/intersection removal settings

The settings are the same as those of the [Text] blocks.



Reference

- "◆ Vertex/intersection removal settings (page 2-27)"
-

◆ Optimized speed

The settings are the same as those of the [Text] blocks.

 **Reference**

-
- "◆ Optimized speed (page 2-27)"
-

◆ Repeat setting

The settings are the same as those of the [Text] blocks.

 **Reference**

-
- "◆ Repeat setting (page 2-28)"
-

◆ Curve surface correction

The settings are the same as those of the [Text] blocks.

 **Reference**

-
- "◆ Curve surface correction (page 2-28)"
-

◆ Marking operation

The settings are the same as those of the [Text] blocks.

 **Reference**

-
- "◆ Marking operation (page 2-28)"
-

● [Laser/Scan] tab**◆ Basic**

The settings are the same as those of the [Text] blocks.

 **Reference**

-
- "◆ Basic (page 2-29)"
-

◆ Advanced

The settings are the same as those of the [Text] blocks.

 **Reference**

-
- "◆ Advanced (page 2-30)"
-



Additional Information

- The laser and scanning settings are usually set through the [Laser/Scan] tab in the [Common setting] and used as the common settings for all marking data. (Refer to "2.7 Common Setting (page 2-108)"). Set individual settings through the [Laser/Scan] tab in the properties for each block individually when it is necessary to set values that are different from the common setting. Excluding [Coefficient] and [Power], any items that are checked will become effective as an individual setting for that block which is independent from the [Common setting].
- Click [Restore default value] to restore the default value. Furthermore, click [Save as default value] to save the settings on the screen as the default values. Note, however, that the above is not applicable to the [Position] settings in the [Form/Position] tab.
- Click [Environment setting] on the menu bar, and then select [Reset to default value] to restore the factory default settings. (Refer to "6.5 Reset to default value (page 6-14)")

Loading the Part File

Loads a registered part file and place it on the sheet.



Reference

A part file is a file in which multiple blocks are registered. For information on how to register the part file, refer to:

- "5.2 Part File Registration Function (page 5-12)"

Setting procedure

- 1 Click  on the block menu, or click [Insert] on the menu bar and then select [Part].
The [Select Part] dialog box is displayed.

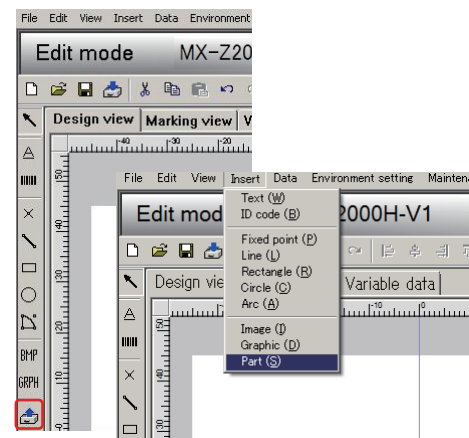

- 2 Select the part file and click [Open].
The content of the part file is displayed.

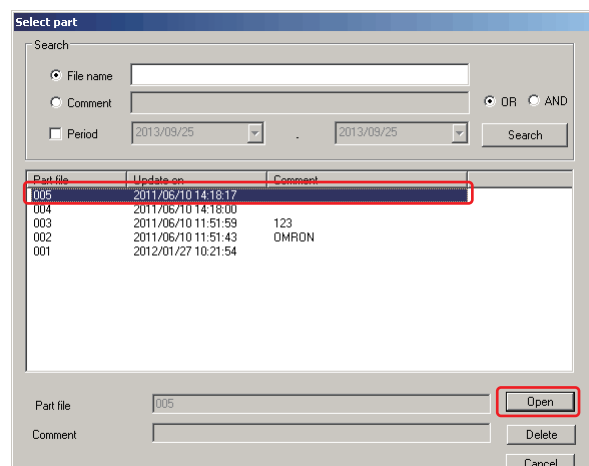



Additional Information

With the [Select part] dialog box, you can search part file with the method described below.

- Search with file name
- Search with comments saved with the part file
- Search with the date (period) of creation
- Search with file name and the date (period) of creation
- Search with comments and the date (period) of creation

You cannot select both [File name] and [Comment] as a search keyword at the same time.

In the [Search] box, select the item that you want to use for the search from above, enter the search keyword and/or period, and then click [search].

You can specify OR and AND conditions. When specifying multiple search keywords, separate the keywords with a comma “,” or semicolon “;”.

The screenshot shows a dialog box titled "Select part" with a "Search" section. It features three radio buttons: "File name" (selected), "Comment", and "Period". There are two text input fields for "File name" and "Comment". Below the "Period" radio button are two date pickers, both showing "2013/09/25". To the right of the input fields are radio buttons for "OR" (selected) and "AND". A "Search" button is located at the bottom right of the dialog.

2.7 Common Setting

This section explains how to specify the marking data common settings.

Click [Common setting] and specify the settings in each tab.

The data set here are applied to the marking data displayed as common settings.



Precautions for Safe Use

The settings of each block property supersedes the common settings.

In the [Laser/Scan] tab, for example, the items set by selecting the check boxes in [Laser/Scan] tab in the block property supersedes the common settings.

■ [Common setting] setting items

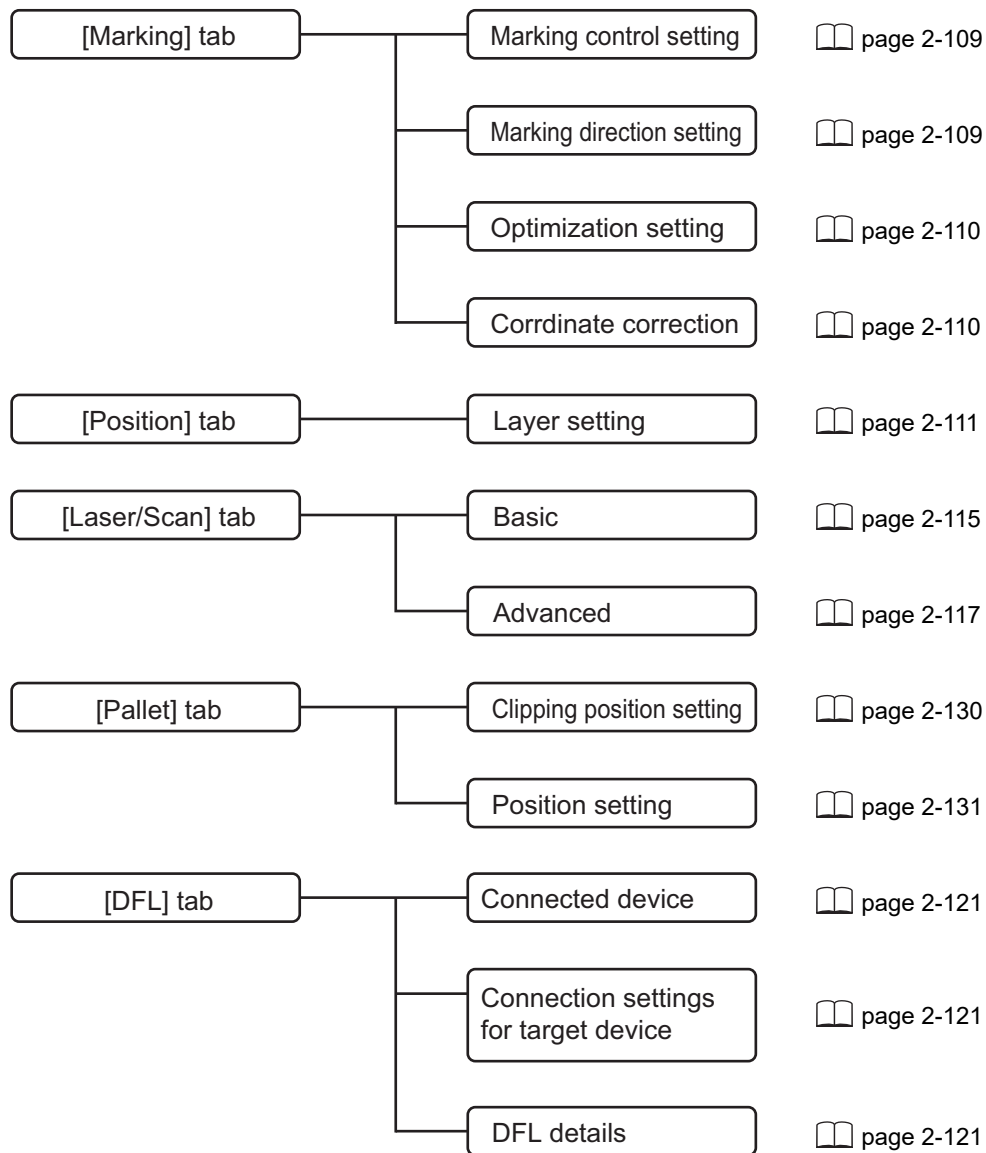

Additional Information

Click [Restore dflt val] to restore the default value. Furthermore, click [Save as dflt value] to save the settings on the screen as the default values.

[Marking] tab● **Marking control setting**

This is set to control marking with an external device.

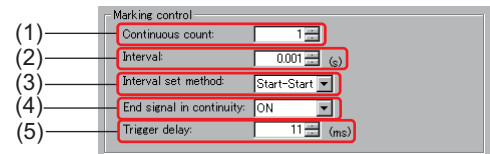
**(1) Continuous count**

Sets the continuous marking count per 1 marking trigger input.

(2) Interval

Sets the marking interval for continuous marking.

(3) Interval set method

Sets when the interval set in “(2) Interval” is to be applied.

- Start-Start: Apply after the pervious marking started until the current marking is started.
- End-Start: Apply after the pervious marking ended until the current marking is started.

(4) End signal in continuity

When performing continuous marking, sets whether or not to output [marking complete output] (external I/O signal) every time one marking is completed.

- None: [Marking complete output] is output when continuous marking is completed.
- ON: [Marking complete output] is output every time one marking is completed.

**Reference**

- “Fiber Laser Marker MX-Z2000H-V1 Setup Manual” (Z415)

(5) Trigger delay

This is set to apply delay time after a marking trigger is input and until the marking is actually started.

● **Marking direction setting**

Specifies the marking settings for all the blocks set on the sheet.

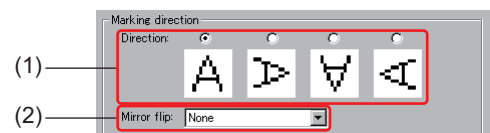
**(1) Direction**

Sets in which direction to mark the blocks.

The specified direction determines the actual marking direction as shown in the figure below.

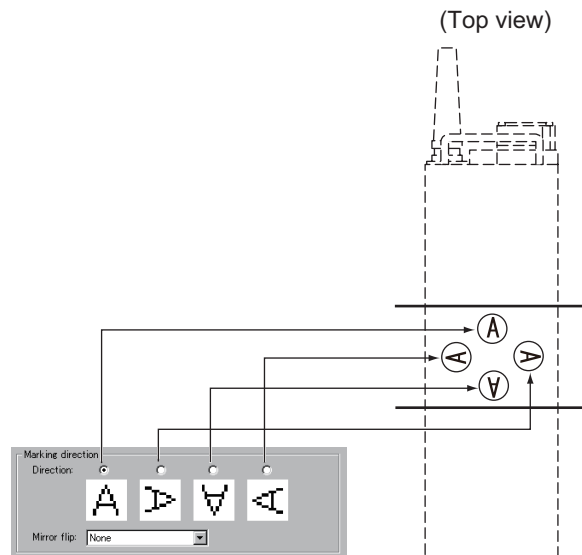

(2) Mirror flip

This is set to flip the blocks.

● **Optimization setting**

This is set to increase the marking speed. When marking is optimized, the system automatically adjusts the marking between multiple, different blocks in order to finish the marking in the shortest amount of time.

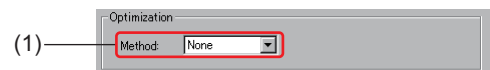

(1) Method

Sets either of the following:

- None: Marking is performed in the preset order without optimization.
- Speed: Marking is optimized in order to finish the marking in the shortest amount of time.

● **Coordinate correct**

Enables the coordinate correct setting to correct the marking coordinates.



(1) Enable

This check box is selected to correct the coordinates.

(2) Correct

Selects the coordinate correct setting.



Reference

- "6.9 Coordinate Correct Setting (page 6-20)"

[Position] tab● **Layer setting**

Set the layer-related settings.

Up to 8 layers can be set per one set of marking data.

(1) Layer count

Sets the layer count.

(2) Select layer diag

Select one of the following according to the work shape.

- Plane
- Column external (X)
- Column external (Y)
- Column internal (X)
- Column internal (Y)
- Cone external (X axis left vertex)
- Cone external (Y axis top vertex)
- Cone external (Y axis bottom vertex)
- Cone external (Z axis vertex)
- Cone internal (X axis right vertex)
- Cone internal (X axis left vertex)
- Cone internal (Y axis top vertex)
- Cone internal (Y axis bottom vertex)
- Cone internal (Z axis vertex)
- Sphere external
- Sphere internal

(3) Correct layer position

Makes position corrections or curved surface settings for the following coordinates and directions for each layer set.

< When [Select layer diag] is [Plane]>

- X correction
- Y correction
- Z correction
- Theta X (θX)
- Theta Y (θY)
- Theta Z (θZ)

<When one of the [Column] shapes is selected for [Select layer diag]>

- X correction
- Y correction
- Z correction
- Radius
- Screen div
- Theta Z (θZ)

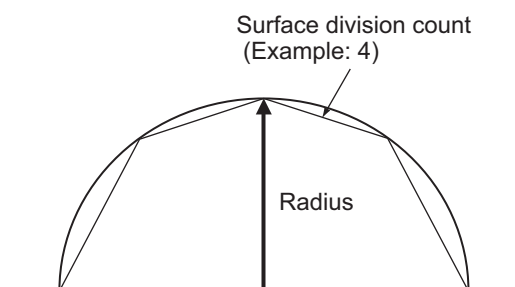
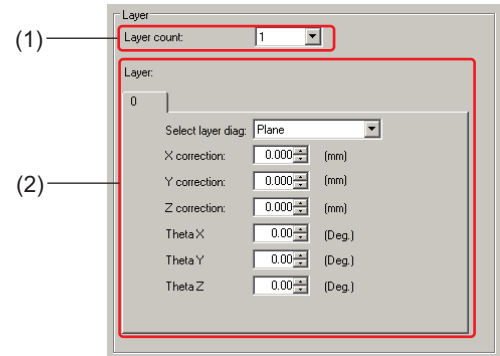

<When one of the [Cone] shapes is selected for [Select layer diag]>

- X correction
- Y correction
- Z correction
- Height
- Surface division count
- θZ correction
- Large circle radius
- Small circle radius
- Cone placement

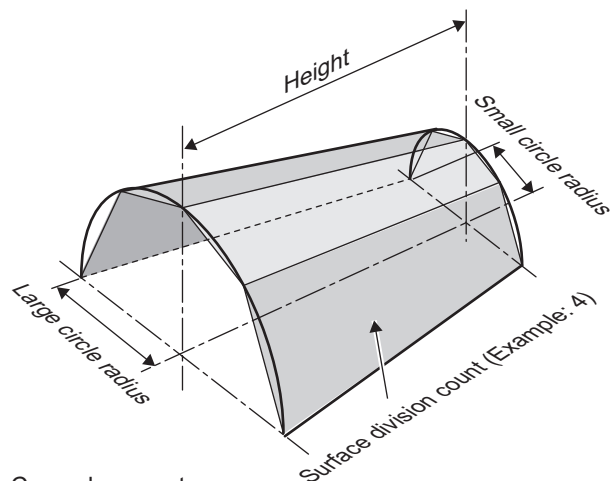

Cone placement

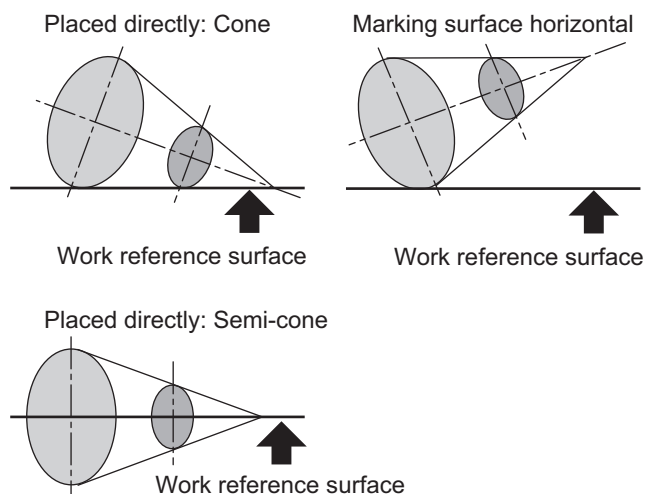

Additional Information

For [Cone external (Z axis vertex)] and [Cone internal (Z axis vertex)], [Cone placement] items are not displayed.

<When one of the [Sphere] shapes is selected for [Select layer diag]>

- X correction
- Y correction
- Z correction
- Horizontal division count
- Vertical division count
- θZ correction
- X radius
- Y radius
- Z radius

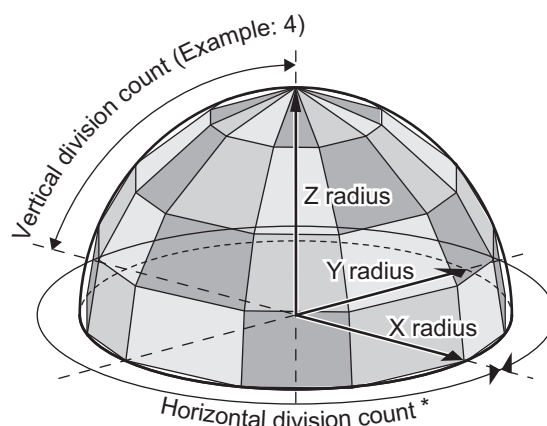

* The number of division of the circumference.
(Example: 12)



Reference

For information on how to create layers and how to switch between layers displayed, refer to:

- "Layer Creation (page 5-9)"
- "Switching Layer (page 5-11)"

For where to focus the pointer during marking, refer to:

- "◆ Focus pointer alignment location (page 1-23)"



Additional Information

2

Layer shape display area

The displayed shape of the layer shape only displays the range that can be marked from the reference.

Using a cone external (placed directly) as an example, the range from the vertex (A) to a location 10 mm^{*1} below it is displayed as the range that can be marked.

When marking within the area indicated by diagonal lines, calculate the diameter from the vertex (B) of the marking area and set the large circle diameter layer setting to that calculated value.

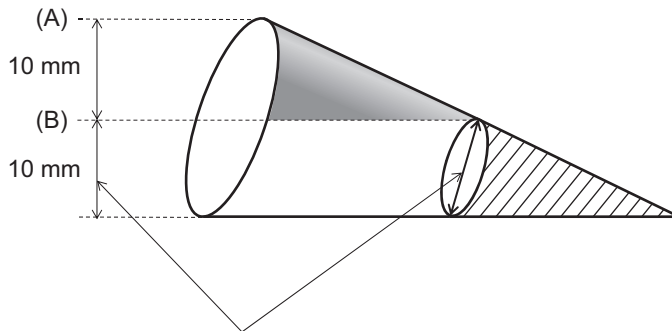

Be careful, as the calculated value is not 10 mm

When using a cone external (Z axis vertex), the range from the vertex (A) to a location 10 mm^{*1} below it is displayed as the range that can be marked.

When marking within the area indicated by diagonal lines, set the large circle diameter layer setting to the diameter of the vertex (B) of the marking area.

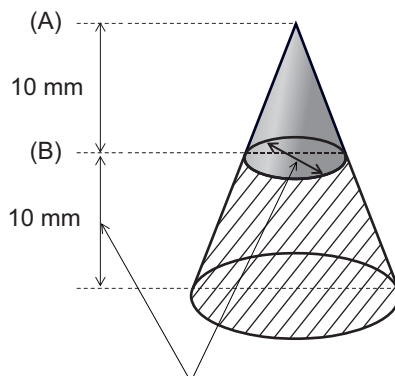

Be careful, as the diameter is not 10 mm

*1 When layer Z correction is 0.00 mm



Additional Information

Marking method that maximizes the adjustment range of the focus distance

The focus distance of the MX-Z2000H-V1 series can be adjusted in the range of ± 10 mm of the reference distance.

A maximum height of 20 mm from the reference point can be marked by setting layer Z correction and the position correction offset.

* Depending on the curvature of the work, it may not be possible to mark a height of 20 mm.

The setting procedure is as follows.

- (1) Select [Common setting] - [Position] and set layer Z correction to 10 mm.
- (2) Select [Maintenance] - [Position correction] and set the offset to 10 mm.
- (3) Align the focus pointer to the work vertex.
- (4) Select [Maintenance] - [Position correction] and return the offset to 0 mm.
- (5) Perform marking.

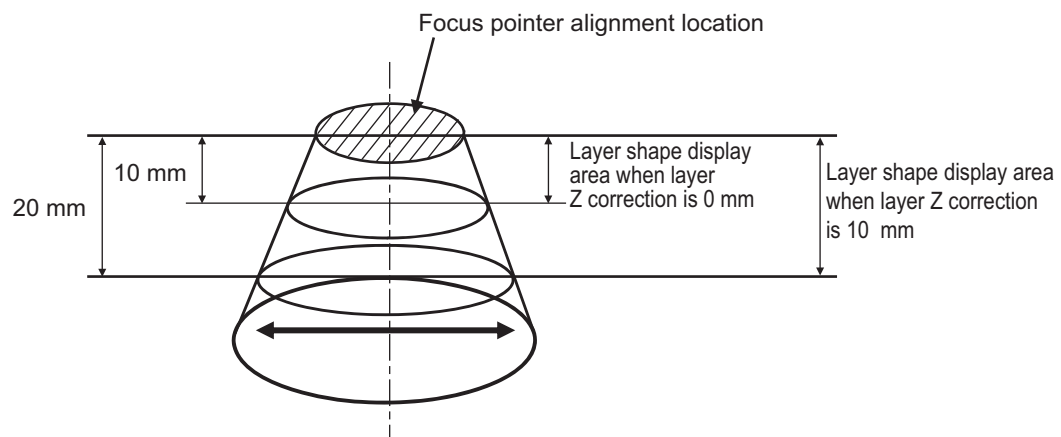
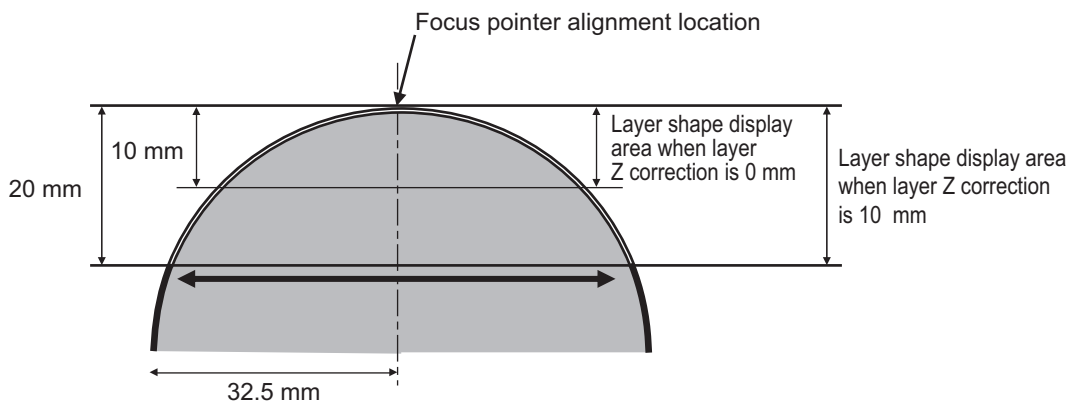

* When the work is a cone external (Z axis vertex), depending on the ratio of the large circle and small circle, it may not be possible to mark a height of 20 mm.

[Laser/Scan] tab● **Basic**

Specifies the basic laser and scanning settings.

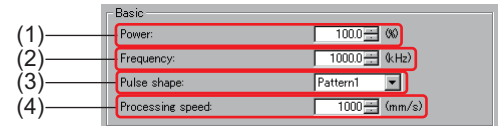
**(1) Power**

Sets the power of the laser.

The power will be limited at or below the 100kHz frequency due to the pulse shape.

Maximum laser power

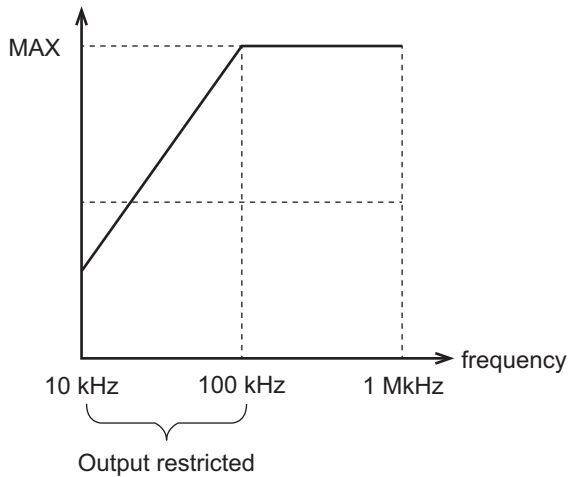

Laser power

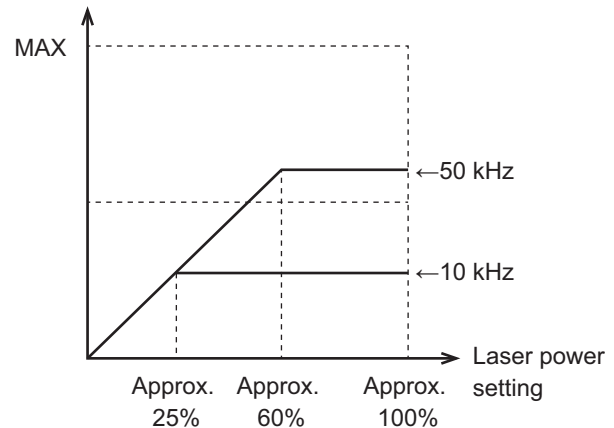

Graph showing restricted laser power when pulse pattern 1 is set

(2) Frequency

Selects the optimum frequency taking the work material, etc. into account.

The frequency can be adjusted in the range between 10.0 and 1000.0 kHz in the standard mode, and in the range between 10.0 to 100.0 kHz in the EE mode.

(3) Pulse shape

Sets the pulse shape of the laser.

The pulse count fluctuates in the range between 7.5 and 300 ns from “Pattern 1” to “Pattern 15” in the standard mode, and in the range between 150 and 450 ns from “Pattern 1” to “Pattern 3” in the EE mode, and the heating time can be adjusted.

Sets the most appropriate pattern based on the work material and purpose.

The group of pulses specified in this pulse shape is emitted in the cycle specified in “(2) Frequency”.

- The laser pulse pattern and the actual number of pulses in the standard mode.

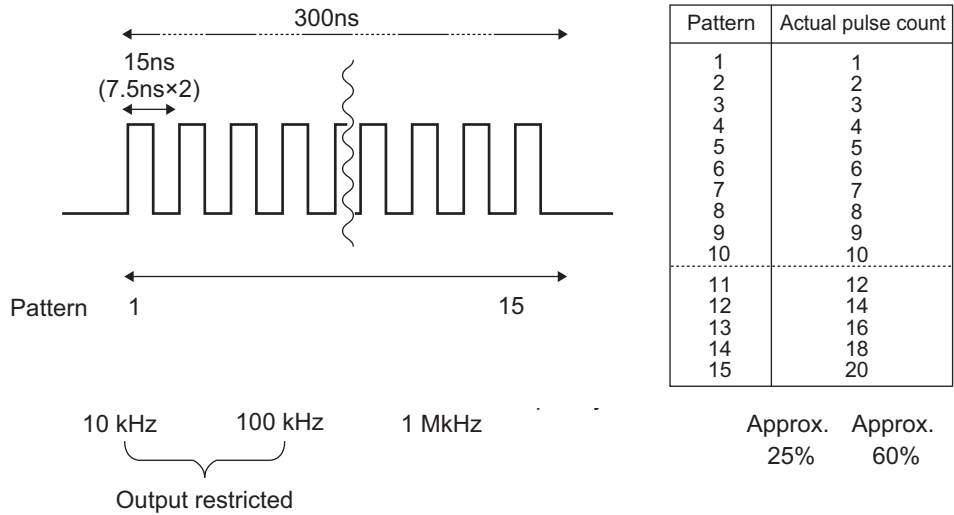

Graph showing restricted laser power when pulse pattern 1 is set



Reference

For details on how to switch between the standard mode and EE mode, refer to:

- "6.10 EE Mode Setting (page 6-24)"

(4) Processing speed

Sets the moving speed when the laser is continuously being emitted (when marking).

- **Advanced**

Specifies the basic laser and scanning settings.

Advanced	
(1)	Moving speed: 1000 (mm/s)
(2)	Wait time after moving: 0.000 (s)
(3)	Vertex wait time: 0.000 (s)
(4)	Vertex wait time effective angle: 45.00 (Deg)
(5)	Runup distance: 0.000 (mm)
(6)	Lead-on distance: 0.000 (mm)
(7)	Runup enable angle: 100.00 (Deg)
(8)	ON delay: 200 (Micro second)
(9)	OFF delay: 200 (Micro second)

(1) Moving speed

Sets the moving speed when the laser is moving between characters or moving to a remote location.

(2) Wait time after moving

Sets the wait time until the next marking after the laser moved.

(3) Vertex wait time

Sets the wait time until the system starts to mark another line after finishing marking a line when marking a vertex.

(4) Vertex wait time effective angle

Sets the angle at which the vertex wait is enabled.

The vertex wait is enabled when the angle is smaller than the value set here.

(5) Runup distance

Sets the distance (runup distance) to start marking another line after finishing marking a line when marking a vertex.

(6) Lead-on distance

Sets the lead-on distance after the marking of a line is finished when marking a vertex.

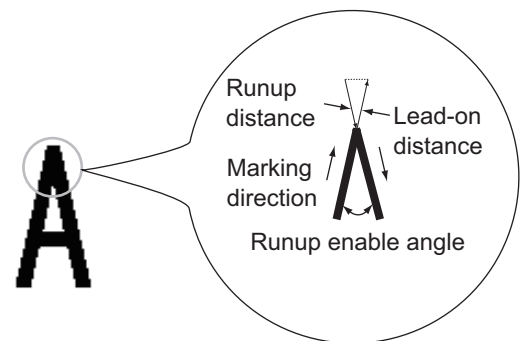

Additional Information

The longer the specified “(5) Runup distance” and “(6) Lead-on distance” are, the shaper the vertex angle will be. Note, however, that the marking speed will go down.

(7) Runup enable angle

Sets the angle at which the runup line is enabled.

The runup line is enabled when the angle is smaller than the value set here.

(8) ON delay

This is set to apply delay time after marking is started and until the laser is actually emitted.

(9) OFF delay

This is set to apply delay time after marking is completed and until the laser is actually emitted.

[Pallet] tab



Reference

For information on the method of pallet marking and the settings, refer to:

- "2.8 Pallet Setting (page 2-125)"
-



Additional Information

- Click [Restore default value] to restore the default value. Furthermore, click [Save as default value] to save the settings on the screen as the default values.
 - Click [Environment setting] on the menu bar, and then select [Reset to default value] to restore the factory default settings. (Refer to "6.5 Reset to default value (page 6-14)")
-

[DFL] tab

The setting procedure for executing DFL is explained using the following as an example.



Reference

For details of DFL setting items, refer to:

- "● [DFL] tab setting items (page 2-121)"
-

● Setting

According to the results of the inspection performed by the FH (IP address: 192.168.0.10), set the marking data that is used when executing marking position correction with the DFL for the text block with "OMRON" entered in block No. 0.

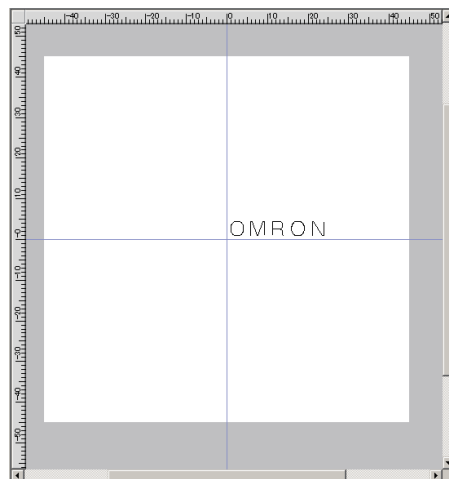

● Setting procedure

- 1 Click  on the block menu, or click [Insert] on the menu bar and then select [Text].
[Text property] is displayed.

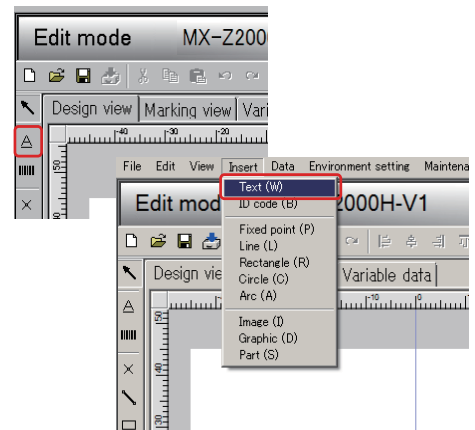

- 2 Set the text to be used as cell data as a block based on the following conditions.

<text>

- Font type/Font name : Stroke/original2
- Text width/Text height : 5 mm/5 mm
- Text spacing/Line spacing : 0.1 mm/0.001 mm
- No font space : Disabled
- Text position : Left
- Coordinate X/Coordinate Y : 0 mm/0 mm

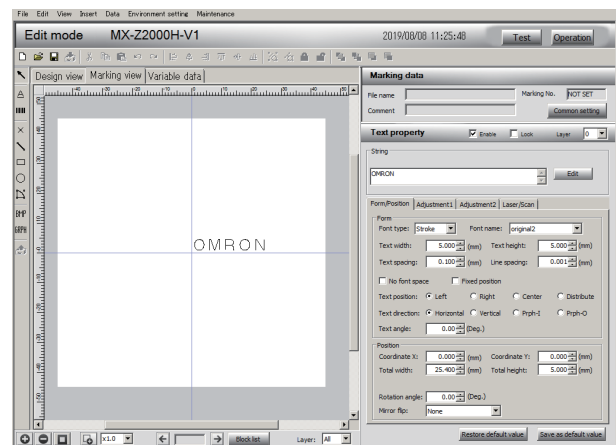

Reference

For information on the [Text] block setting, refer to:

- "[Text] Block (page 2-14)"

- 3 Click [Common setting], and then select the [DFL] tab.

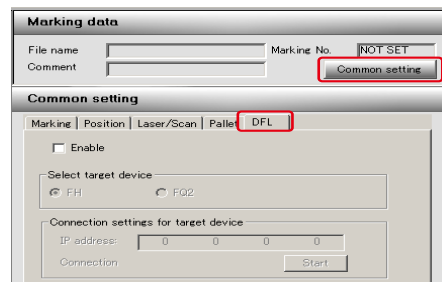

- 4 Select [Enable] and select FH in [Connected Device].

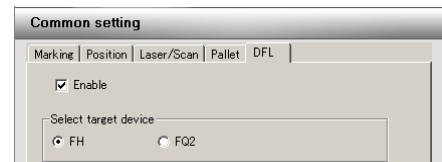

- 5 Set the IP address of the FH to connect in [Connection settings for target device].
IP address: 192.168.250.10

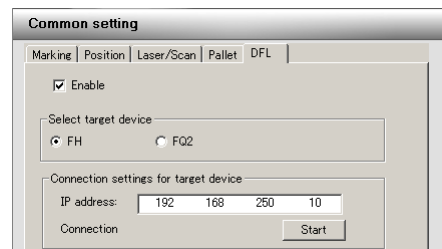

Additional Information

When [Start] in the [Connection test] column is clicked, connection with the FH that has the IP address specified in [IP address] column is confirmed. The dialog box is displayed when a connection failure occurs.
Confirm the connection status of the communication settings and LAN cable.

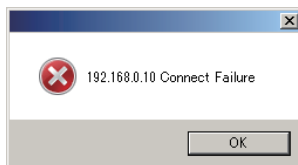

- 6 After checking [Marking position correction scene No.], set it as the block according to the following conditions.

- Marking position correction scene No.: 1
- Block No.: 0
- Timeout: 60s

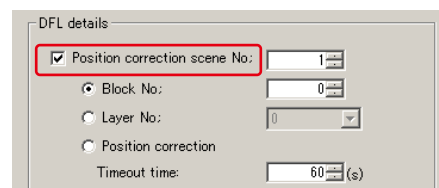

Additional Information

Set the scene number in advance on the FH side.

● [DFL] tab setting items

◆ Target Device

Select the device to connect when using DFL.

(1) Device

Select the inspection device to use with DFL from “FH” or “FQ2”.

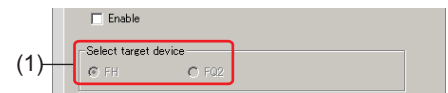

◆ Connection settings for target device

When using DFL, set up a connection for the device to inspect.

(1) IP address

Set the IP address of the connected to the laser marker.

(2) Connection test

Perform a connection test on the whose IP address was set in (1).

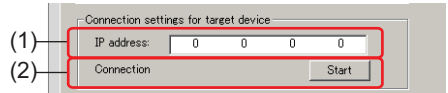

◆ DFL details

Select the inspections to perform with DFL and set the target block and other items.

📄 Precautions for Correct Use

- When FQ2 is selected as a Target Device, items related to marking position correction (1) to (3) cannot be set.

(1) Position correction scene No.

Set the inspection scene for the position correction registered with the FH.

(2) Block No./Layer No./Position correction

Select the marking target for which the position correction is performed.

If you select “Block No.”, correction is performed on the selected block.

If you select “Layer No.”, correction is performed on the entire layer selected.

If you select “Position correction”, correction is performed on the entire area.

(3) Timeout time

Set the time that is judged to be a timeout by the laser marker during the position correction inspection performed by the FH.

When a timeout occurs, the laser marker judges that it is an error and stops the operation.

(4) 2D code inspection scene No.

Set the inspection scene for the 2D code inspection registered with the vision sensor.

(5) Unreadable code detected

Select the marker operation performed when the code is judged to be unreadable during the 2D code inspection performed by the vision sensor.

- Stop...An error alarm is issued by the laser marker.
- Continue...Processed normally by the marker.

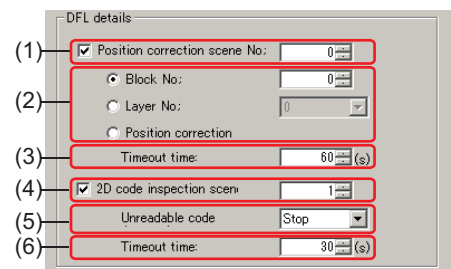

(6) Timeout time

Set the time that is judged to be a timeout by the laser marker during the 2D code inspection performed by the vision sensor.

When a timeout occurs, the laser marker judges that it is an error and stops the operation.



Reference

For details of error codes and their remedial actions, refer to:

- “Fiber Laser Marker MX-Z2000H-V1 series Setup Manual” (Z415)

■ Presettings on the FH

When you use the DFL, the following settings must be specified on the FH.

● Communication settings

The following setting must be specified in [Communication module select].

Item	Set value
Fieldbus	EtherNet/IP

● EtherNet/IP™ output specifications

For communication settings, the following settings must be specified as output specifications of the EtherNet/IP™.

Item	Set value
None	None
Output period	Longer than output time.
Output period	200.0 ms or longer
User area	OFF



Additional Information

Output time

The laser marker checks the FH output signal every 100 ms.

Set the FH output time to a value larger than 200 ms in order to ensure that the FH output signal is obtained.

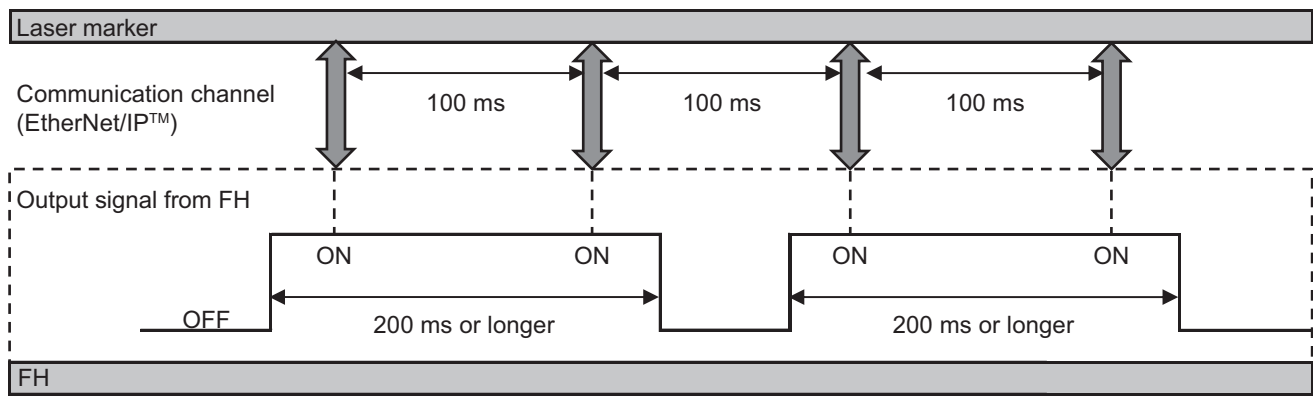

● Output Items registration

◆ Marking position correction

The laser marker performs marking position correction based on the results of the Fieldbus data output from the vision sensor. Add the Fieldbus data output to the scene for which marking position correction is performed.

Specify the items that are output with Fieldbus data output and the output format as follows.

Item	Description	
Fieldbus Data Output	No.0	Correction distance in the X axis direction
	No.1	Correction distance in the Y axis direction
	No.2	Rotation angle θ
Output Format	Decimal output form	Fixed point



Additional Information

- Output the correction distance in the unit of mm.
- The laser marker performs marking position correction with the value output from the FH (rounded off to the fourth decimal place).
- The positive value of the rotation angle indicates left rotation, and the negative value indicates right rotation.

◆ 2D code inspection

Add the processing item “2D Codes” to the scene for which the 2D code inspection is performed. When the inspection results of all processing units registered in the scene for which the inspection was performed by the vision sensor are “Passed”, the code is judged to be readable.



Reference

For information on general usage of the vision sensor FH and operation procedures, refer to:

- “Vision System FH/FZ5 Series User's Manual” (Z365)

For information on how to register inspections configured on the vision sensor FH and their details, refer to:

- “Vision System FH/FZ5 Series Processing Item Function Reference Manual” (Z341)
- “Vision System FH/FZ5 Series User's Manual for Communications Settings” (Z342)

■ Presettings on the FQ2

When you use the DFL, the following settings must be specified on the FQ2.

● Feildbus data output

The following setting must be specified in [Feildbus data output].

Otem	Set value
Comm. Type	EtherNet/IP
Output handshake	No
Output data size	32 bytes
Refreshing task period	10.0ms
Data output period	Longer than Gate output time.
GATE signal ON period	200.0ms or longer



Additional Information

Output time

The laser marker checks the FQ2 output signal every 100 ms.

Set the FQ2 output time to a value larger than 200 ms in order to ensure that the FQ2 output signal is obtained.

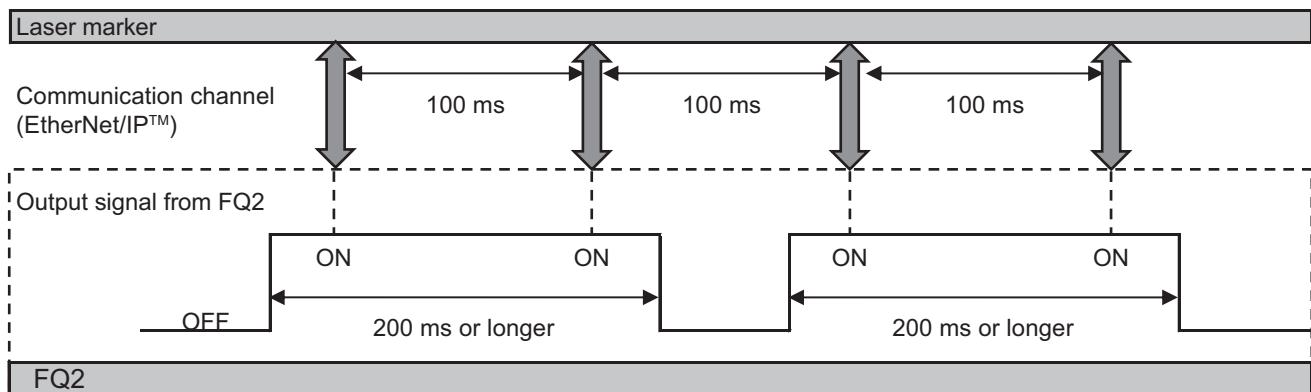

● Output Items registration

◆ 2D code inspection

Add the processing item “2D Codes” to the scene for which the 2D code inspection is performed. Specify the items that are output with Fieldbus data output and the output format as follows.

Otem	Set value	Set value
Output paramater	Reflect	Yes
Link data output	No.0	Judgement
Output charactrer set	String out put off	off
Output format	Output form	Fixed point

When the inspection results of all processing units registered in the scene for which the inspection was performed by the vision sensor are “Passed”, the code is judged to be readable.



Reference

For information on general usage of the vision sensor FQ2 and operation procedures, refer to:

- “Smart camera FQ2-S/CH Series User's Manual” (Z337)

For information on how to register inspections configured on the vision sensor FQ2 and their details, refer to:

- “Smart camera FQ2-S/CH Series User's Manual for Communication Settings” (Z338)

2.8 Pallet Setting

The procedure for setting the pallet when performing pallet marking is explained using the following as an example.

■ Setting

Sets a 3-column by 5-row (cell count: 15) pallet with string, "OMRON" and a 5-digit counter as 1 set of cell data.

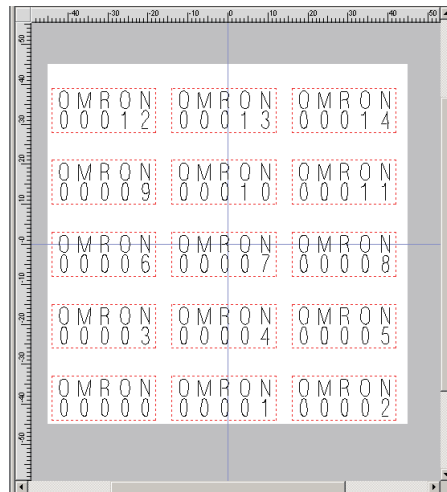

■ Setting procedure

- 1 Click  on the block menu, or click [Insert] on the menu bar and then select [Text].
[Text property] is displayed.

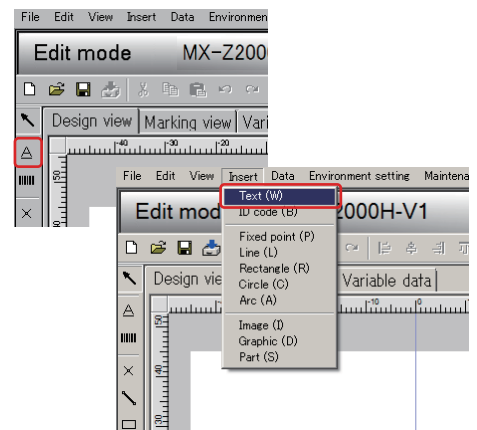

2 Set the string and the counter to be used as cell data as a block based on the following conditions.

<String>

- Font type/Font name : Stroke/original2
- Text width/Text height : 5 mm/5 mm
- Text spacing/Line spacing : 0.1 mm/0.001 mm
- No font space : Disabled
- Text position : Left
- Coordinate X/Coordinate Y : 0 mm/0 mm

<Counter>

- Counter No. : 0
- Initial value/End value : 0/99999
- Step : 1
- Initial timing : Change marking data
- Count timing : Cell
- Align text : Shift to Right
- No zero suppression : Enable
- Digit : 5 digits
- Base : 10

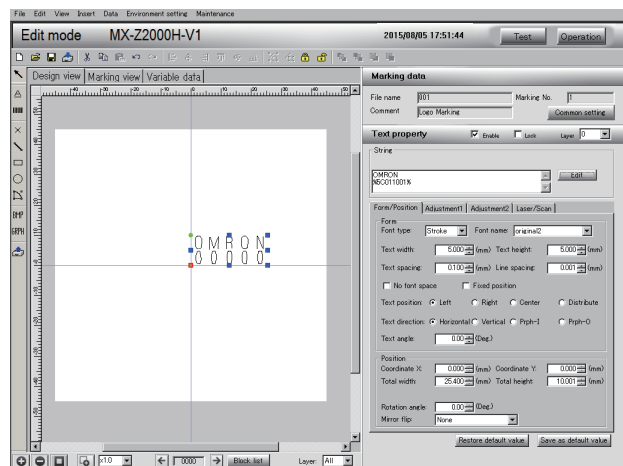

Reference

For information on the string and block setting of the counter, refer to:

- "[Text] Block (page 2-14)"

3 Click [Common setting], and then select the [Pallet] tab.

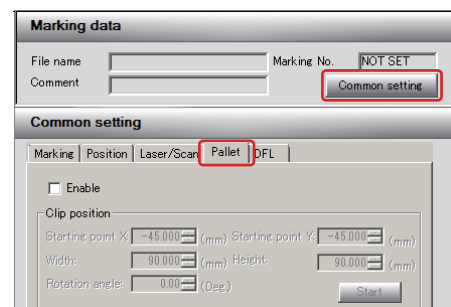

4 Upon selecting the [Enable] check box, set the following values in [Clip position] to clip the data as cell data.

- Starting point X/Starting point Y : -0.5 mm/-0.5 mm
- Width/Height : 26 mm/11 mm

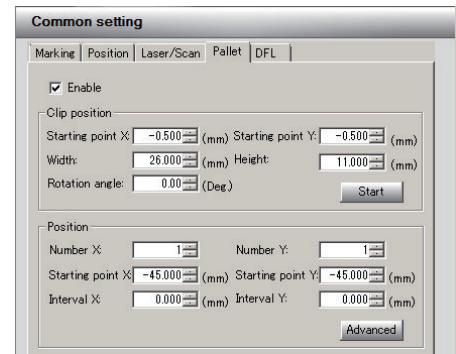

2

 **Additional Information**

Cell data can also be clipped using the mouse. Upon clicking [Start], drag the mouse to specify the clip area, and click [Stop].

5 Select the [Marking view] tab.

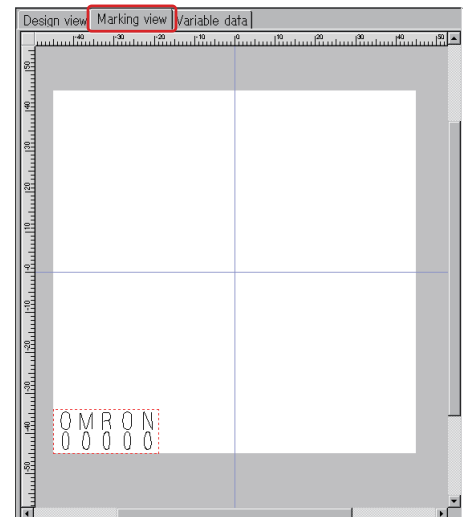

 **Additional Information**

Specify the pallet layout settings in the marking view.

6 Specify the following pallet settings in [Position].

- Number X/Number Y : 3/5
- Starting point X/Starting point Y : -44 mm/-44 mm
- Interval X/Interval Y : 30 mm/18 mm

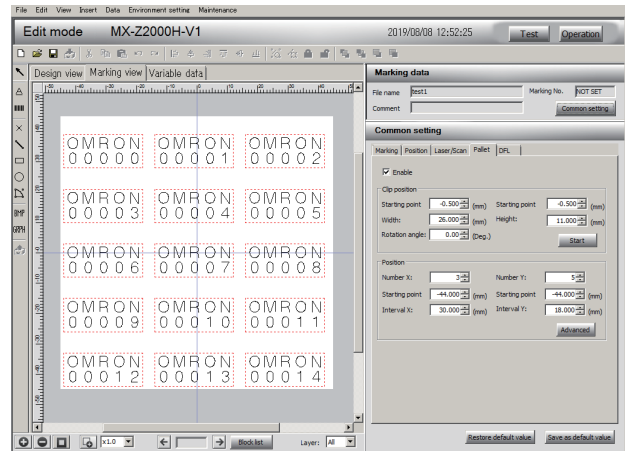

7 Click [Advanced].

The [Pallet advanced settings] dialog box is displayed.

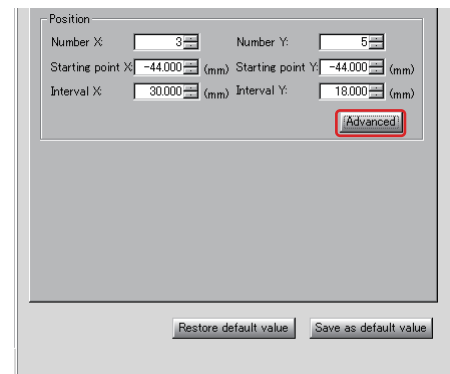

8 After selecting "All" in [Specify by], select the check box for [Enable count-up] in [Change] and click [Change].

The count up setting will be enabled for all cells.

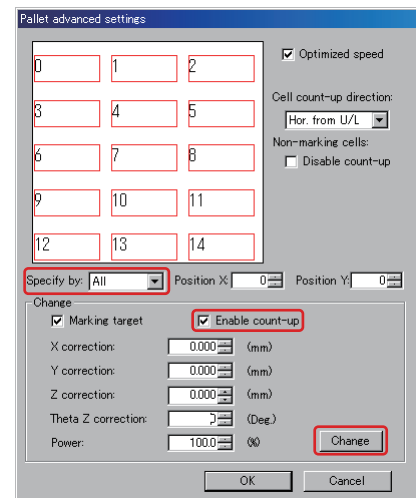

- 9 Set the following and click [OK].
- Cell count-up direction: Hor. From D/L

Pallet advanced settings

12	13	14
9	10	11
6	7	8
3	4	5
0	1	2

Optimized speed

Cell count-up direction:
Hor. from D/L

Non-marking cells:
 Disable count-up

Specify by: All Position X: 0 Position Y: 0

Change

Marking target Enable count-up

X correction: 0.000 (mm)

Y correction: 0.000 (mm)

Z correction: 0.000 (mm)

Theta Z correction: 0 (Deg.)

Power: 100.0 (%)

Change

OK Cancel

The pallet is set based on the conditions specified for the sheet.

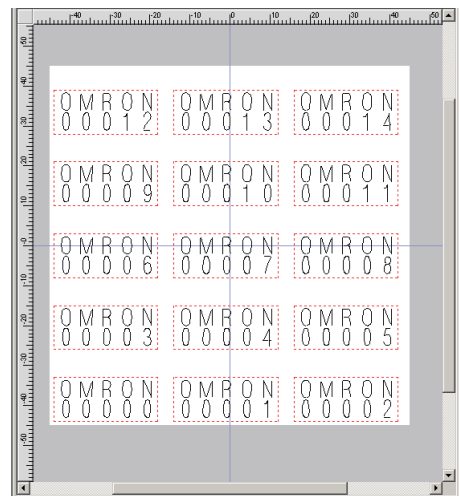

■ [Pallet] tab setting items

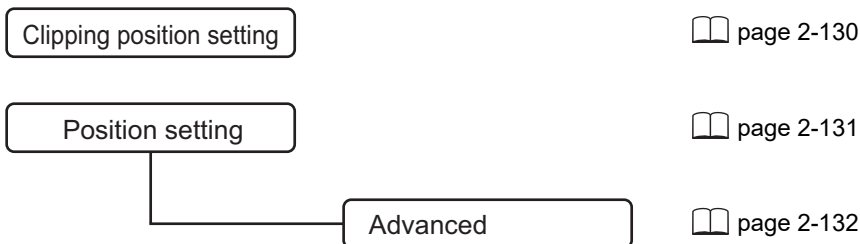

● Clipping position setting

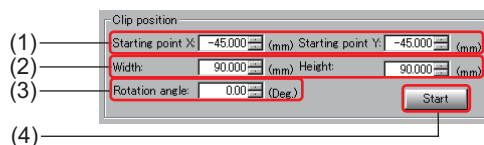

- (1) **Starting point X/Starting point Y**
Sets the start point X and start point Y of the area to be clipped as cell data.
- (2) **Width/Height**
Sets the width and height of the area to be clipped as cell data with the start point set as the reference.

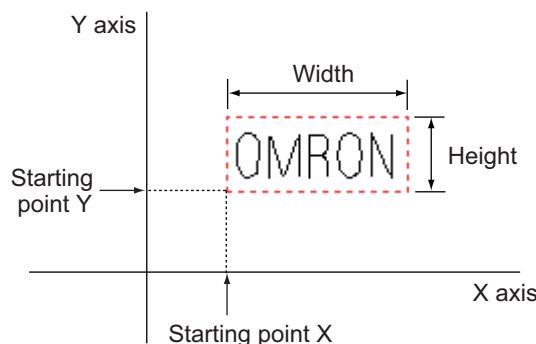

 **Precautions for Correct Use**

Only the blocks completely inside the clipped area are targeted for pallet marking. Blocks of which even a portion of it is outside of the area are not targeted for marking. Blocks that are not targeted for marking will be displayed in red.

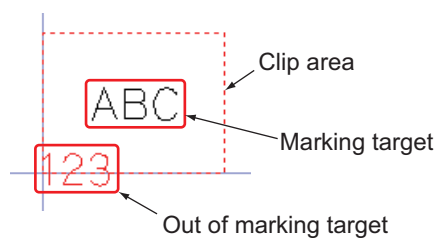

- (3) **Rotation angle**
Sets the rotation angle against X-axis when marking the area clipped as cell data. The block is rotated to the left at the specified angle with the lower left of the area as the reference point.
- (4) **[Start]/[Stop]**
[Start] is clicked to specify the area to be clipped by dragging the mouse. Upon specifying the area, [Stop] is clicked to confirm the area.

● Position setting

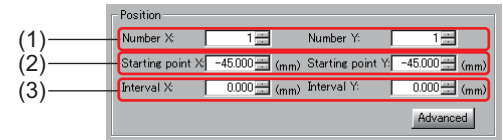

2

(1) Number X/Number Y

Sets the counts X (cell column count) and Y (cell row count) of the cells to be placed on the pallet.

A value between 1 and 255 can be set for each of these values.

(2) Starting point X/Starting point Y

Sets the start point of the cell to be placed on the pallet (the lower-left position of the cell to be placed in the lower-left area of the pallet).

(3) Interval X/Interval Y

Sets the interval X (cell column interval) and interval Y (cell row interval) of the cells to be placed on the pallet.

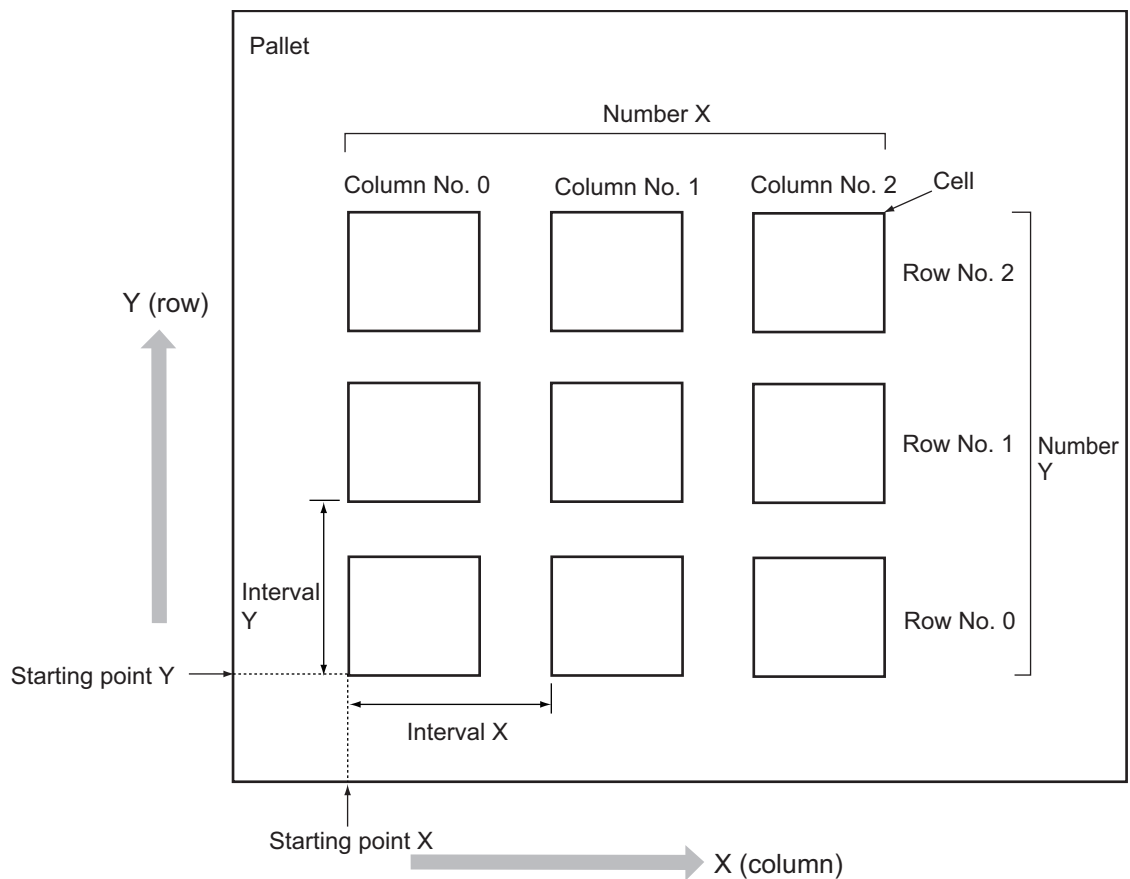

● [Pallet advanced settings] dialog box

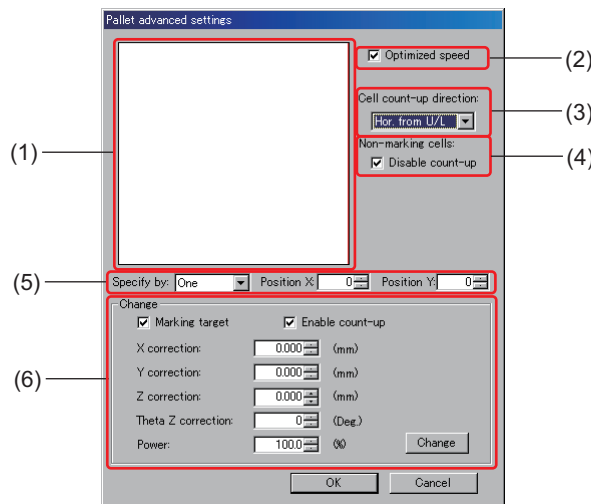

(1) Cell array

The cells in the specified count will be shown in figure.

(2) Optimized speed

- Cleared: If the counter is being used, the count, even if marking is stopped midway, can be resumed at the position where it was stopped.
- Selected: The marking speed is accelerated. If marking is stopped midway when the counter is being used, check the counter value and resume marking.

(3) Cell count-up direction

Sets the count up direction when performing counter marking the cells on the pallet.

When the direction is set, the cells shown in the figure in “(1) Cell array” will be counted up in that direction.

(Example)

• Hor. From D/L

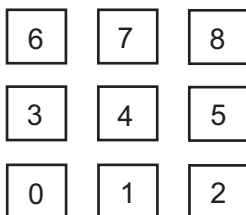

• Vrt. from U/L

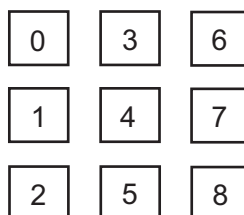

(4) Non-marking cells

If a non-marking cell is present on the pallet and to exclude that cell from the count up, the [Disable count-up] check box is selected.

(5) Specify by/Position X/Position Y

Sets the method of specifying the cells to be targeted for “(6) Change.”

- One: Specifies one cell at a time.
- Hor. fixed: All cells in the row specified in [Position Y] in the cell array are specified as a group.
- Ver. fixed: All cells in the column specified in [Position X] in the cell array are specified as a group.
- All: All cells are specified as a group.

(6) Change

This is set to change the specified cells.

- Marking target: This check box is selected to target the specified cells for marking.
- Enable count-up: This check box is selected to count up the specified cells. When this is cleared, the counter value that equals that of the last cell will be marked.
- X correction/Y correction/Theta Z (θZ) correction: Sets the correction value (offset value) when correcting positions of the specified cells.
- Power: Sets the laser power for the specified cells individually.
- [Change]: Applies changes made to the cells specified in "(5) Specify by."

2.9 Saving the Marking Data

Saves the block settings and the common settings as marking data.



Additional Information

If you create new marking data or turn the system power OFF without saving the marking data, all contents created and edited will be lost.

Save

Overwrites and save the marking data with the same name.

- 1 Click [File] on the menu bar, and then select [Save] (or click  on the toolbar).

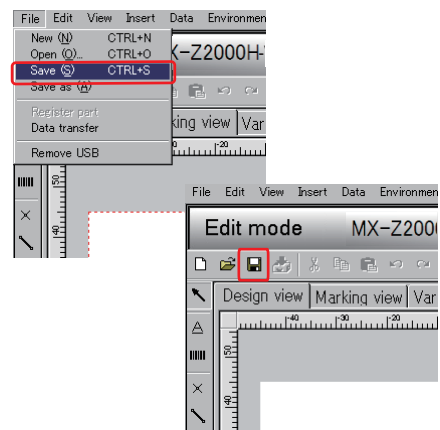

Save As

Saves the marking data with a new name.

- 1 Click [File] on the menu bar, and then select [Save as]. The [Save marking data] dialog box is displayed.

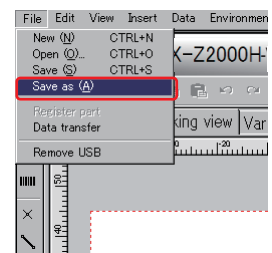

- 2** Enter a desired file name in [File name], any desired comment in [Comment], the marking data number from 0 to 9999 in [Marking No.], select the marking marker software version with [format], and then click [Save].

A marking data number can be a value between 0 and 9999.

File name	Marking No.	Update on	Comment
005	7	2013/08/16 17:42:47	Data001
004	8	2013/08/16 17:43:06	Data002
003	9	2013/08/16 17:43:21	Data003
002	10	2013/08/16 17:43:56	Data004
001	11	2013/08/16 17:44:34	Data005



Additional Information

- Formats

This is specified to use marking data with an old version of the marking software. Select the format supported by the software version.

- ver4.0: Software Ver.4.0x or later
- ver3.1: Software Ver.3.1x or later
- ver3.0: Software Ver.3.0x or later
- ver2.1: Software Ver.2.1x or later
- ver2.0: Software Ver. 2.0x and later
- ver1.4: Software Ver. 1.4x and later
- ver1.3: Software Ver. 1.3x and later
- ver1.2: Software Ver. 1.0x, 1.1x, and 1.2x

Caution: The settings for functions that do not exist in the old version are lost.

- Acquiring an unused number

When an existing file name or marking data number is specified in [File name] or [Marking No.], an overwrite confirmation message is displayed. Unused marking numbers can be assigned with [Acquire open Number].

For file names, only the characters that can be displayed with ASCII codes or S-JIS are supported.

Chapter 3

Performing Test Marking

Perform test marking after creating marking data to determine if the settings are appropriate.

3.1	Performing Test Marking	3-2
-----	-------------------------------	-----

3.1 Performing Test Marking

Perform the test marking with the laser.

Danger

- When shining the laser in order to adjust the marking position, users are required to wear protective goggles in order to protect their eyes, as well as flame-retardant clothing. Use protective goggles with an optical density (OD) appropriate for 1,064 nm wavelengths, and which can be used to confirm laser radiation warnings.
- Do not stare into the laser, as this may result in blindness or burns even if you are wearing protective goggles.

■ Performing procedure

- 1 Click **[Test]** on the **[Edit mode]** screen.
The **[Test marking]** dialog box is displayed.

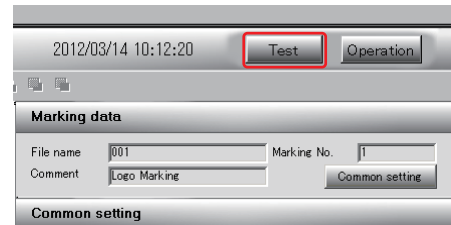

- 2 Confirm that **[Ready]** is displayed.

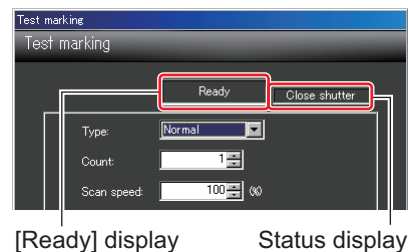

[Ready] display

Status display



Additional Information

The status display that appear in the **[Test marking]** dialog box are as follows.

- **[In operation]**: Marking is currently being performed.
- **[Error]**: An error has occurred on the system.
- **[Emergency stop]**: The emergency stop switch on the system (**[EMERGENCY]** button) is pressed, or external emergency stop input signal is turned ON.
- **[STOP ON]**: External marking stop input signal is turned ON.
- **[Laser OFF]**: External laser control input signal is turned OFF.
- **[Close shutter]**: External shutter closing signal is turned ON.

For details on external control signal, refer to "Fiber Laser Marker MX-Z2000H-V1 series Setup Manual" (Z415).

- 3 Set the settings in the **[Test marking]** dialog box.
Refer to "■ Setting (page 3-4)"

- 4 Click [Start].**
A message confirming a start of marking is displayed.

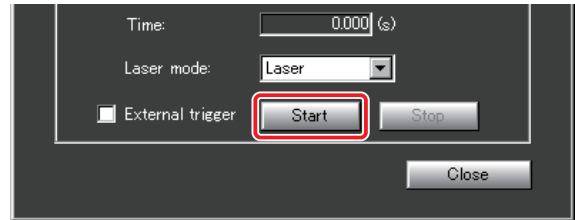

3

- 5 Click [Yes].**
The [Close shutter] display will change to [In operation] and the test marking will start.

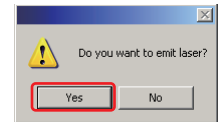

Precautions for Correct Use

Do not turn OFF the breaker of and key switch of this system while test marking is being performed. To stop marking due to an emergency or an error, press the emergency stop switch on the controller ([EMERGENCY] button).

To stop test marking in the middle, click [Stop].

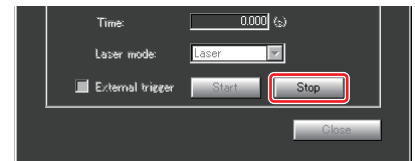

During test marking, the time elapsed from the start of the test marking is displayed in [Time].

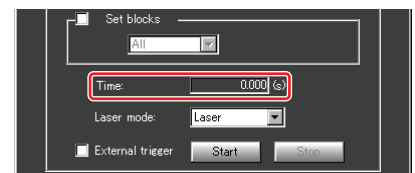

When test marking is completed, laser emission stops and the [In operation] display changes to [Close shutter].

- 6 Click [Close].**

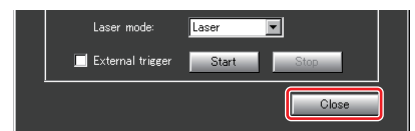

- 7 Upon confirming the marking status, change the marking data settings, if necessary, and repeat test marking to determine the optimum marking conditions.**

■ Setting

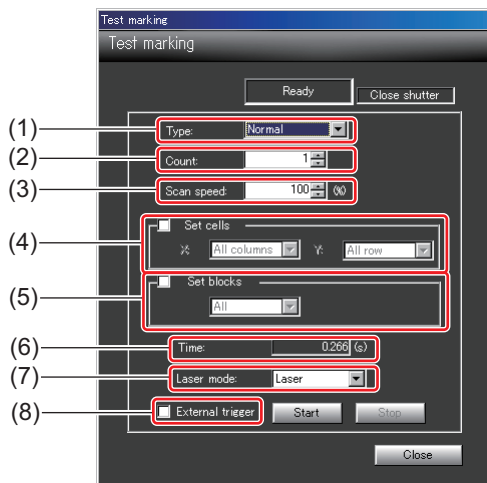

(1) Type

The test marking type from the following is selected.

Item	Description
Normal	Emits the marking target with laser or guide laser (based on the "(7) Laser mode" setting). (Normal status)
Marking frame	Emits the frame specified as the marking target with laser or guide laser. This is used to check the marking position by guide laser, etc.
Block frame	Emits each block frame with laser or guide laser. This is used to check the marking position by guide laser, etc.
Marking area	Emits the maximum frame of the marking area (MX-Z2000H-V1: 90 x 90 mm / MX-Z2050H-V1/Z2055H-V1: 160 x 160 mm) by laser or guide laser.
Area guide	Emits a guide laser pattern of a square divided into four equal squares (MX-Z2000H-V1: 45 x 45 mm / MX-Z2050H-V1/Z2055H-V1: 80 x 80 mm) by laser or guide laser.
Center point	Emits the center of the marking area with laser or guide laser.

(2) Count

Sets the number of times to perform test marking.

This setting supersedes the marking count specified in [Common setting] in the [Edit mode] screen.

(3) Scan speed

Sets the scan speed for test marking when the scan speed setting specified in [Common setting] and in the block property setting is set as 100%.

(4) Set cells

This checkbox is selected to specify the cell for test marking when performing pallet marking. Sets the cell column number in [X] and the cell row number in [Y].

(Example)

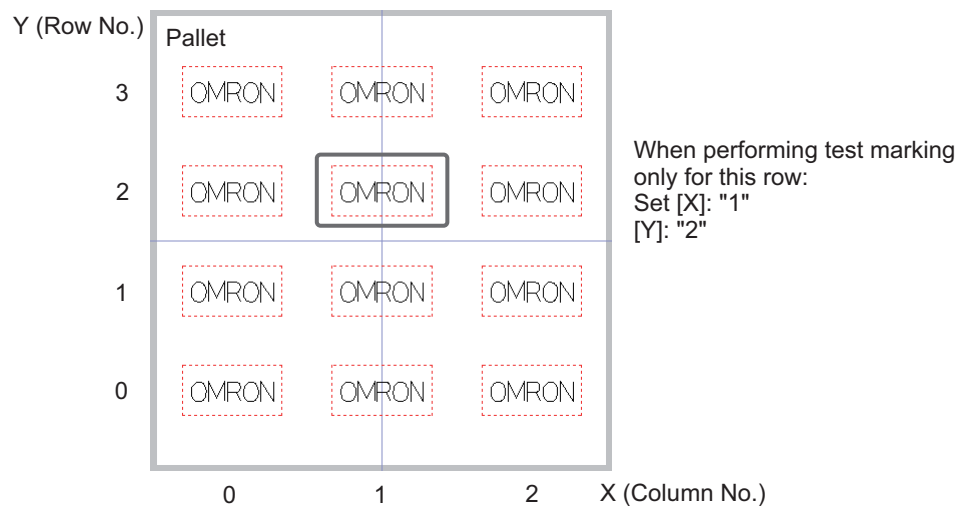
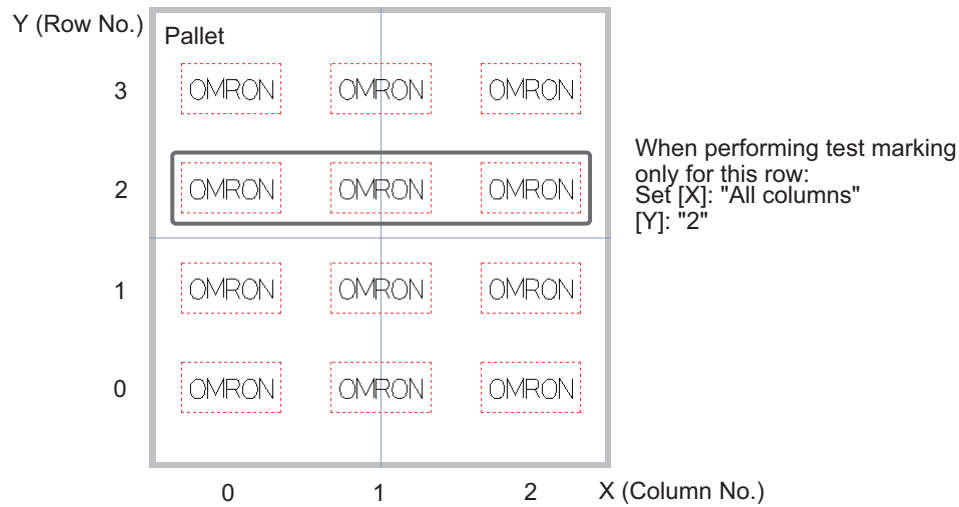
**(5) Set blocks**

This checkbox is selected to specify the block for test marking, and the block number is set. This is enabled when "Normal" or "Block frame" is specified in "(1) Type."

(6) Time

The time elapsed from the start of the test marking is displayed.

(7) Laser mode

Either of the following is selected.

Item	Description
Laser	Marking is executed with actual laser.
Guide laser	Marking content is scanned with guide laser.

(8) External trigger

This checkbox is selected to perform test marking with external trigger signal input.



Additional Information

[Start]/[Stop] are enabled even when external trigger is enabled.

Chapter 4

Marking

Call and perform marking on the marking data that has been created.

4.1	Flow of Marking Tasks	4-2
4.2	Screen Configuration	4-3
4.3	Loading the Marking Data	4-5
4.4	Starting Marking	4-7
4.5	Monitoring Marking Status	4-9
4.6	Monitoring Error Status	4-14

4.1 Flow of Marking Tasks

The flow of performing an actual marking task is as illustrated in the figure below.

Call and perform marking on the marking data in the operation mode.

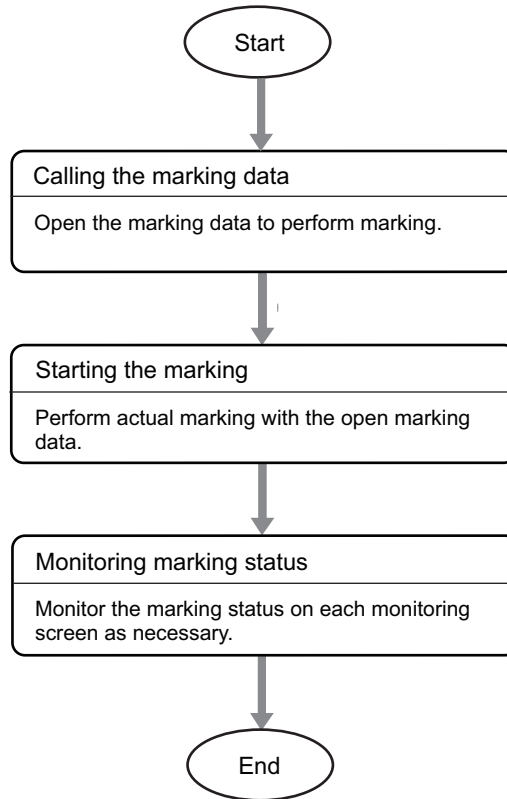

4.2 Screen Configuration

The configuration of the [Operation mode] screen is explained.

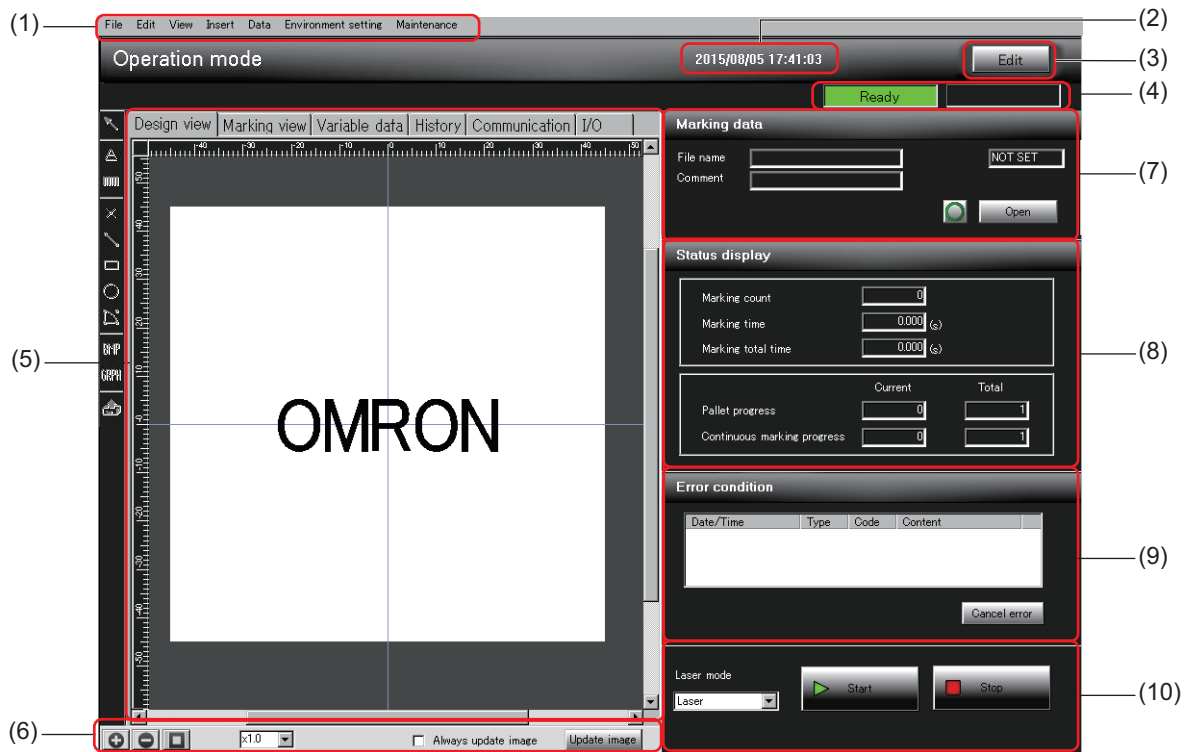

(1) Menu bar

This is the marker software function menu.
The functions that can be used are limited in the operation mode.

Reference

- "A.1 Specifications of Menu Bar and Toolbar (page A-2)"

(2) Current date/time

The current date and time are displayed.

(3) Screen mode selection area

Switches to the [Edit mode] screen to create or edit marking data.

(4) Marking ready display area

Indicates whether or not the system is ready for marking.

(5) Sheet

Marking content is displayed.

Also, the counter, time hold and variable data settings are specified, and the marking status is monitored by switching tabs.

(6) View setting/Update image area

Enlarges/shrinks the sheet and updates the marking image.

(7) Marking data information display area

The file name, marking data number, and comment for the marking data that is currently open are displayed.

The marking data is opened by clicking [Open].

(8) Status display area

The current marking status is displayed.

(9) Error status display area

Error status is displayed when an error has occurred.

(10) Laser mode selection and Marking start/stop operation area

Operates to select the laser output mode for marking and start or stop marking.

4.3 Loading the Marking Data

Load and open the marking data to be marked.

- 1 Click **[Open]** on the **[Operation mode]** screen.
The **[Select marking data]** dialog box is displayed.

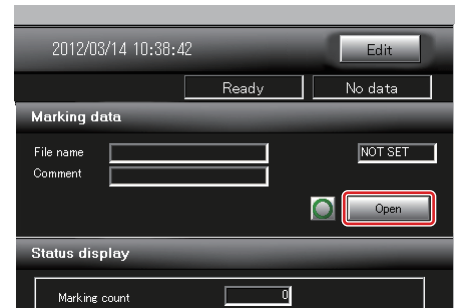

Additional Information

- If the lock button to the left of **[Open]** is turned ON, **[Open]** is disabled. Click the lock button to unlock it.



Lock button
(Lock ON)

You can specify in the startup settings whether to start up the system with the lock turned ON or OFF. (Refer to "■ Setting at startup (page 1-15)")

- If you perform this operation without saving the marking data currently being created, a message confirming unsaved data will be displayed. To save the data, click **[No]** and save the data. Click **[Yes]** to open new marking data without saving it. In this case, the marking data being created will be deleted.

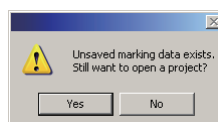

2 Select the marking data to be marked, and click [Open].

Marking data will open.

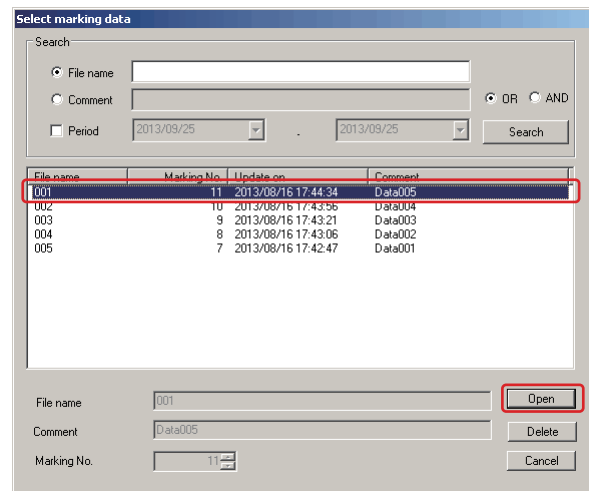

Additional Information

- With the [Select marking data] dialog box, you can search marking data with the method described below.
 - Search with file name
 - Search with comments saved with the marking data
 - Search with the date (period) of creation
 - Search with file name and the date (period) of creation
 - Search with comments and the date (period) of creation

You cannot select both [File name] and [Comment] as a search keyword at the same time.

In the [Search] box, select the item that you want to use for the search from above, enter the search keyword and/or period, and then click [search].

You can specify OR and AND conditions. When specifying multiple search keywords, separate the keywords with a comma "," or semicolon ";".

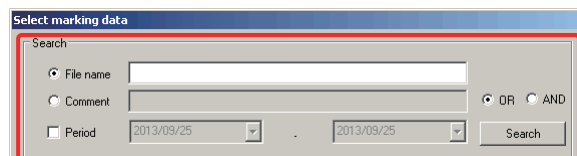

- Select the marking data in the [Select marking data] dialog box and click [Delete] to delete the selected marking data.
- Click [Update image] to update the marking image to the latest image. In addition, if you select the [Always update image] checkbox, the marking image gets updated every time the marking target is changed. This is used in situations, such as when monitoring the current counter value on the screen. Clear the checkbox, however, if there is no particular need for this function as using it will slow down the marking speed. This setting is automatically saved and will be applied when the system is started next time.

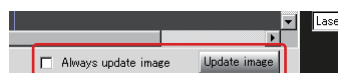

4.4 Starting Marking

Check the marking content and perform marking.

- 1 Confirm that [Ready] is displayed in green in the marking ready display area.

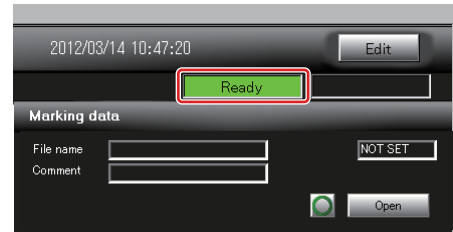

Additional Information

If anything other than [Ready] in green is displayed, the system is not ready for marking, and marking cannot be performed. (Refer to "3.1 Performing Test Marking (page 3-2)")

- 2 In [Laser mode] in the Laser mode selection and Marking start/stop command area, select one of the following laser output modes.

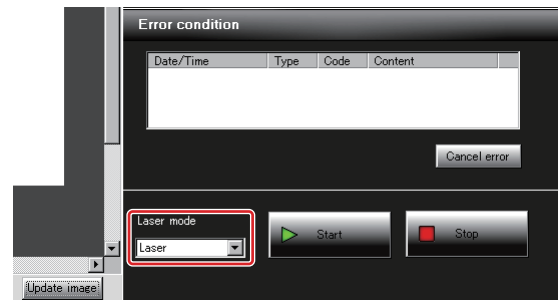

Item	Description
Laser	Marking is executed with actual laser.
Guide laser	Marking content is scanned with guide laser.

- 3 Click [Start].
A message confirming a start of marking is displayed.

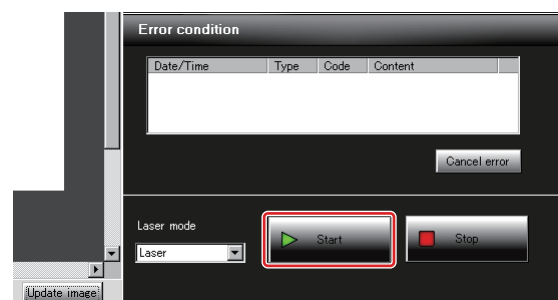

- 4 Click [Yes].
Marking is started.

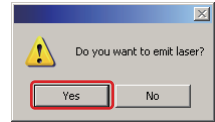

To stop marking in the middle, click [Stop].

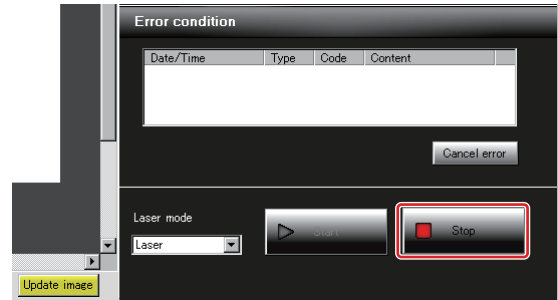

Precautions for Correct Use

Do not turn OFF the breaker and key switch of this system while marking is being performed. To stop marking due to an emergency or an error, press the emergency stop switch on the controller ([EMERGENCY] button).

When the marking of the specified marking data is completed, the laser emission will stop.

4.5 Monitoring Marking Status

The marking status can be monitored on the [Operation mode] screen.

4

Monitoring Current Marking Status

The current marking progress is displayed in the status display area.

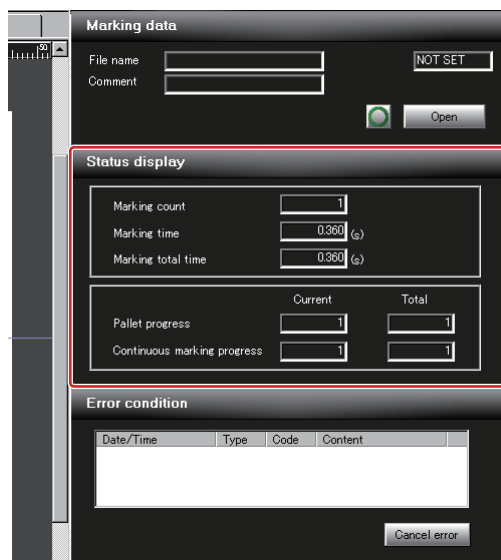

The details of each item are as follows:

Item	Description
Marking count	Displays the number of marking operations from the start of the marking to the current.
Marking time	Displays the marking time from the start of the marking to the current.
Marking total time	Displays the total marking time (accumulative) from the start of the marking to the current.
Pallet progress	Displays the number of pallets processed by pallet marking (current count and total count).
Continuous marking progress	Displays the number of marking processed by continuous marking (current count and total count).



Additional Information

The monitor display is reset when marking data is replaced.

Monitoring Counter, Time Hold and Variable Data

With the [Variable data] tab selected, the current status can be monitored during a marking operation using counter marking, time hold time, and a variable data table.

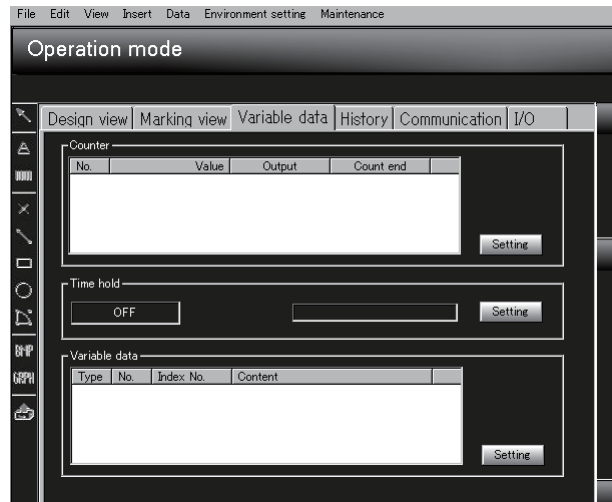

■ Counter monitor

When a counter is being marked, the counter number, current value, output destination upon completion, and the count complete/incomplete status are displayed.

■ Time hold monitor

When the time hold setting is enabled by selecting [Data] - [Time hold] on the menu bar, or through an external signal, this area indicates [ON] and the setting time is displayed on the right side.

■ Variable data monitor

The table type, table number, index number and index content are displayed when data from a variable data table is being marked.



Additional Information

Click [Setting] to display the setting dialog box for each item.

Monitoring Marking Operation History/Error History

The marking operation history and the error history (date/time and description) can be monitored by clicking the [History] tab.

Switch the view of the history type in [Select trace type].

Up to 100 items can be displayed.

4

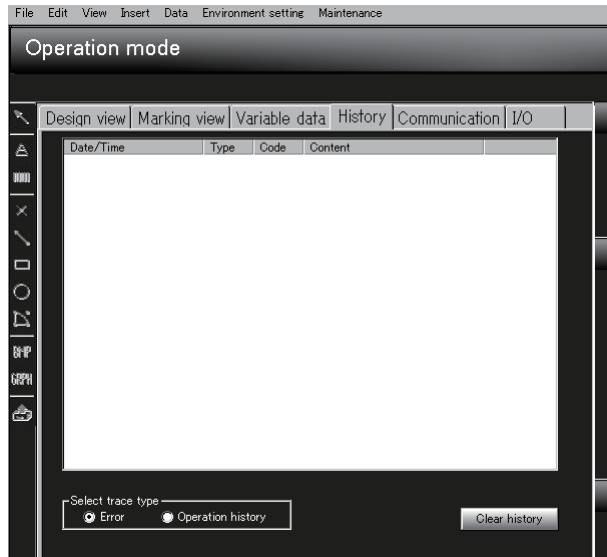

■ Selecting history type to view

Select either [Error] or [Operation history] under [Select trace type].

■ Clear history

Click [Clear history] to clear all that is displayed on the screen.

Communication Monitor

Select the [Com] tab to monitor command bit/data of the I/O communication with an external device, marking trigger input and serial communication, Ethernet communication, and EtherNet/IP™ communication commands/responses when external control is performed.

Up to 100 items can be displayed.

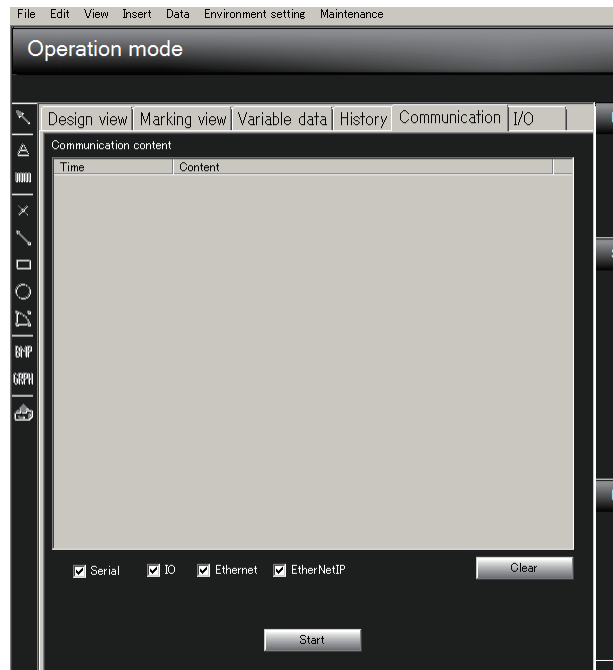

■ Communication content

Time	Shows the time when the command was sent/received.
Description	Shows the communication type, sending/receiving, and the command content.

- Communication type IO I/O communication
 - SCI Serial communication
 - Ether Ethernet communication
 - EtherNetIP EtherNetIP™ communication
- Sending/receiving Snd Laser marker sends a data
 - Rcv Laser marker receives a data



Additional Information

For details on commands shown for I/O communication, refer to "Fiber Laser Marker MX-Z2000H-V1 series Setup Manual" (Z415).

For examples of commands shown for serial communication, Ethernet communication, and EtherNet/IP™ communication, refer to: "● Control command example (page 8-7)".

■ Selecting the communication type to monitor

Select [Serial] to monitor serial communication, [IO] to monitor I/O communication, [Ethernet] to monitor Ethernet communication, and [EtherNet/IP] to monitor EtherNet/IP™ communication.

■ Starting/stopping monitoring

Click [Start] to start monitoring and [Stop] to stop monitoring.

■ Clearing the view

Click [Clear] to clear all that is displayed on the screen.

I/O Monitor

Select the [I/O] tab to the button, I/O terminal block and I/O connector ON/OFF status can be monitored.

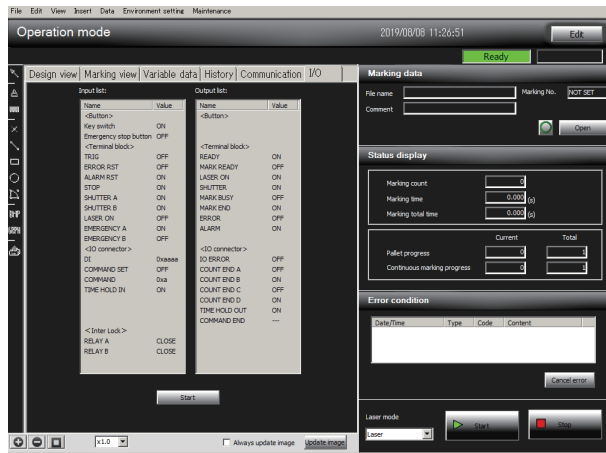

■ Starting/stopping monitoring

Click [Start] to start monitoring and [Stop] to stop monitoring.

4.6 Monitoring Error Status

The error status can be monitored on the [Operation mode] screen.

Monitoring Error Status

If an error (major trouble) or an alarm (maintenance notice) is generated during marking, the error status display area will indicate the date and time of the error or alarm, error type (ERROR-A or ERROR-B), and its details. The error can be also cancelled.

The content of information (minor trouble), if occurred, will also be displayed.

The screenshot shows a control panel with the following sections:

- Status display:**
 - Marking count: 1
 - Marking time: 0.360 (s)
 - Marking total time: 0.360 (s)
 - Pallet progress: Current 1, Total 1
 - Continuous marking progress: Current 1, Total 1
- Error condition:**

Date/Time	Type	Code	Content

Cancel error
- Laser mode:**
 - Dropdown menu: Laser
 - Start button (green play icon)
 - Stop button (red stop icon)

Description of Error Status Display

For details of the description displayed, refer to "Fiber Laser Marker MX-Z2000H-V1 series Setup Manual" (Z415).

Cancelling the Error

Troubleshoot the error and click [Cancel error] to clear all error display.



Additional Information

This function restores the system to the same condition as when the key switch is reset from OFF to ON.

Chapter 5

Useful Functions

This chapter explains the functions that are useful for creating marking data and for performing marking.

5.1	View Setting Function.....	5-2
5.2	Part File Registration Function.....	5-12
5.3	Block List Display Function	5-13
5.4	Variable Data Table Setting Function	5-17
5.5	Date/Time Variable Data Table Setting Function.....	5-30
5.6	Counter Setting Function	5-45
5.7	Time Hold Calculation Function	5-48
5.8	Marking Time Calculation Function	5-49
5.9	Other Functions.....	5-50

5.1 View Setting Function

This section explains the sheet view setting functions to create and edit marking data efficiently.

Zoom In/Zoom Out

You can zoom in/out (x 0.5 to x 512) on the sheet.

- 1 Click [View] on the menu bar and, and then select [Zoom], and select one of the following from the sub-menu.

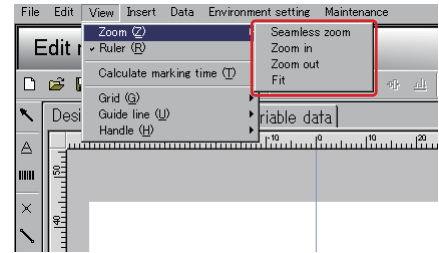

Item	Description
Seamless zoom	Zooms in on the area specified by a dragging of the mouse.
Zoom in	Zooms in at x 2 of the current display magnification ratio.
Zoom out	Zooms out at x 1/2 of the current display magnification ratio.
Fit	Sets to the magnification ratio of x 1.0 (100%) regardless of the current display magnification ratio.



Additional Information

The view area can be zoomed in/out with the buttons below the sheet to change the view setting and blocks.

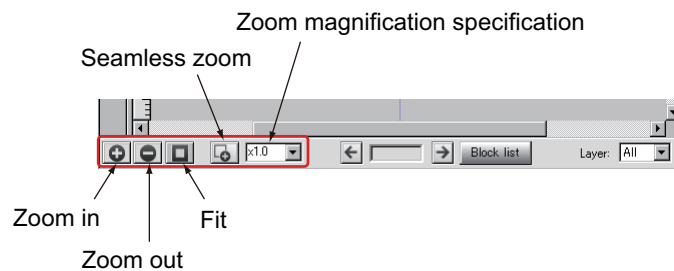

Ruler View

Rulers are displayed on the sheet.

- 1 Click [View] on the menu bar, and then select [Ruler].

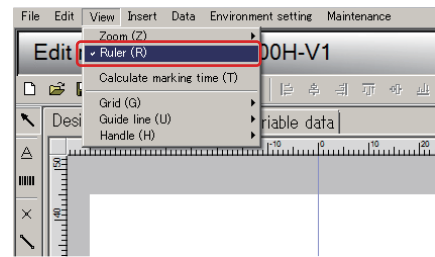

A check mark is placed on the left side of the menu display, and the rulers are displayed at the top and left sides of the sheet.

When you select [View] - [Ruler] again, the rulers will disappear.

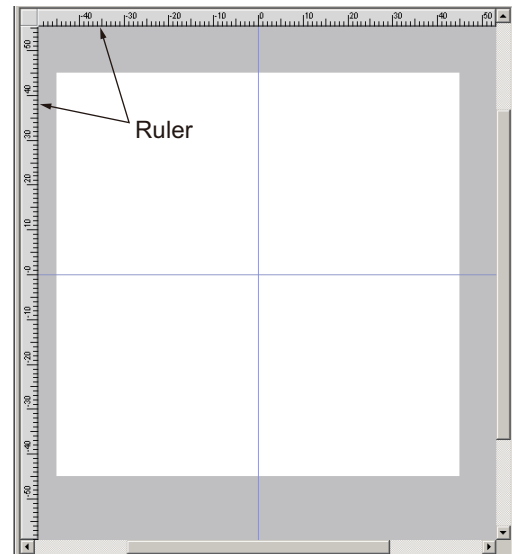

Additional Information

The rulers are set to "View" in the default setting.

Grid View

Grids are displayed on the sheet.

- 1 Click [View] on the menu bar, and then select [Grid] and [View].

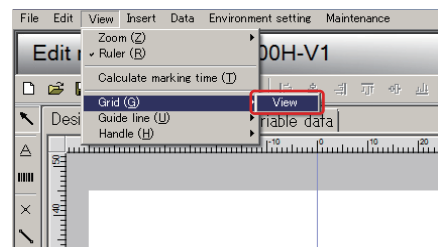

A check mark is placed on the left side of the menu display, and grids are displayed on the sheet.

When you select [View] - [Grid] - [View] again, the grids will disappear.

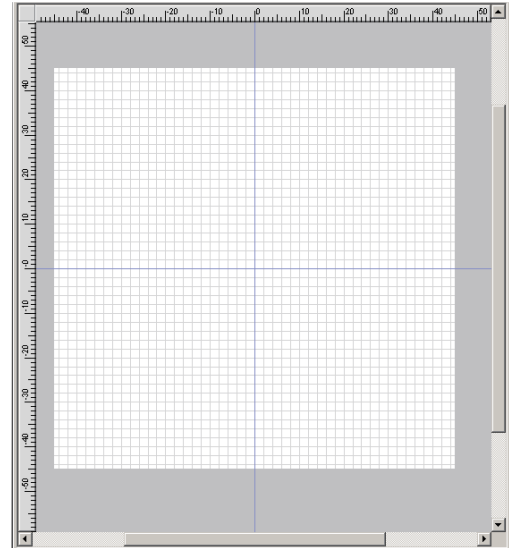

Additional Information

You can specify the grid intervals and whether or not to display grids when you start the marker software in the [Edit setting] dialog box that is displayed when you select [Environment setting] - [Edit] on the menu bar. (Refer to "6.2 Edit Setting (page 6-8)")

Guide Line View

A guideline is displayed on the sheet.

Up to 10 guide lines can be displayed vertically and horizontally each on 1 sheet.

- 1 Click [View] on the menu bar, and then select [Guide line] and [View].

A check mark is placed on the left side of the menu display.

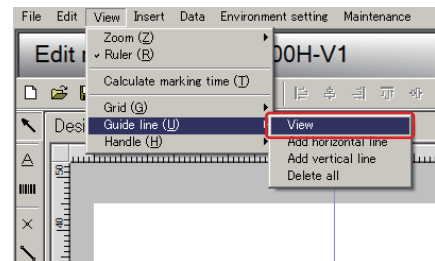

- 2 Click [View] on the menu bar, and then select [Guide line] and [Add horizontal line]/[Add vertical line].

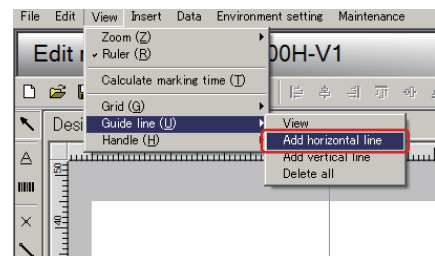

A check mark is placed on the left side of the menu display, and a guide line (red) is displayed on the center line (blue) in the view area.

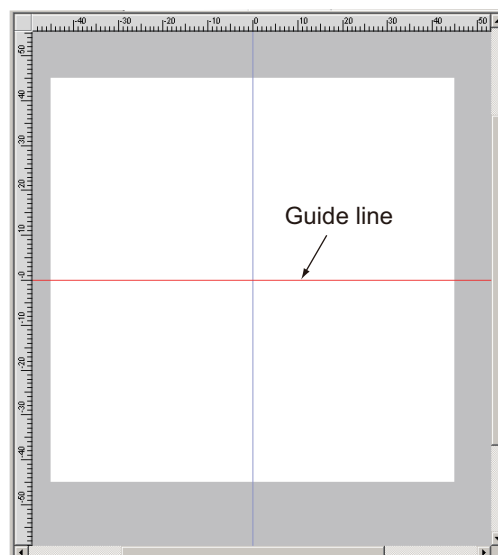

5

3 Drag the guide line to any position.

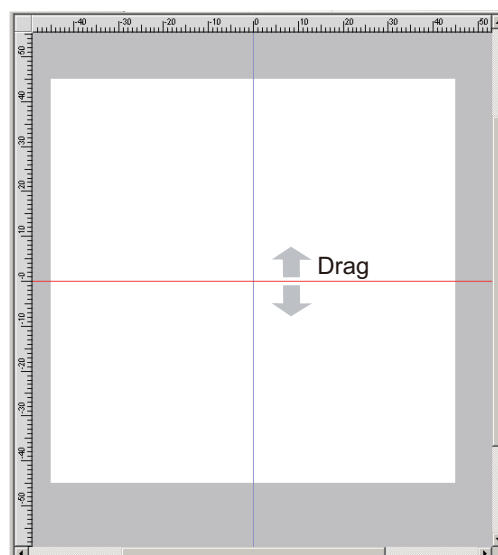

To display multiple guide lines, repeat steps 2 to 3.

When you select [View] - [Guide line] - [View] again, all guide lines will be hidden. By selecting [View] - [Guide line] - [View], switch between displaying/hiding all guide lines.

■ Deleting the guide line

When you select [View] - [Guide line] - [Delete all] on the menu bar, all guide lines on the sheet will be deleted.

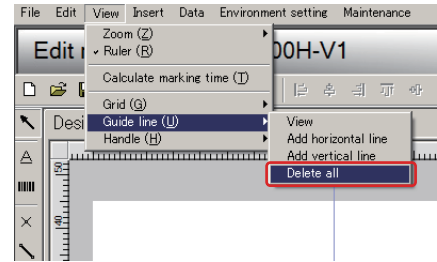

Additional Information

You can specify whether or not to display guide lines when you start the marker software in the [Edit setting] dialog box that is displayed when you select [Environment setting] - [Edit] on the menu bar. (Refer to "6.2 Edit Setting (page 6-8)")

Handle Snap Setting

When there are multiple blocks, the handle of the selected block can be snapped to the handle of another block within the set distance.

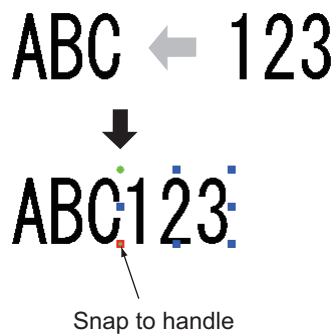

- 1 Select the block to which the handle is to be snapped.
- 2 Click [View] on the menu bar, and then select [Handle] and [Snap].

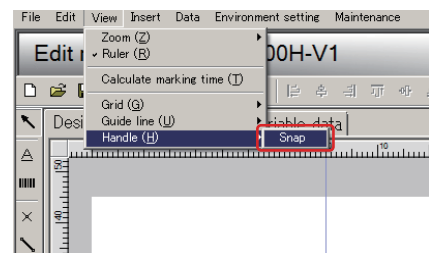

Additional Information

You can specify the distance between the handles to be snapped and whether or not to specify the handle snap setting when you start the marker software in the [Edit setting] dialog box that is displayed when you select [Environment setting] - [Edit] on the menu bar. (Refer to "6.2 Edit Setting (page 6-8)")

Non-marking Target Setting/Lock Setting

When multiple blocks are created on a sheet, a particular block can be removed from the marking target, or it can be locked so that its position cannot be moved.

■ Non-marking target setting

Select the block to be set as non-marking target, and clear the [Enable] checkbox.

5

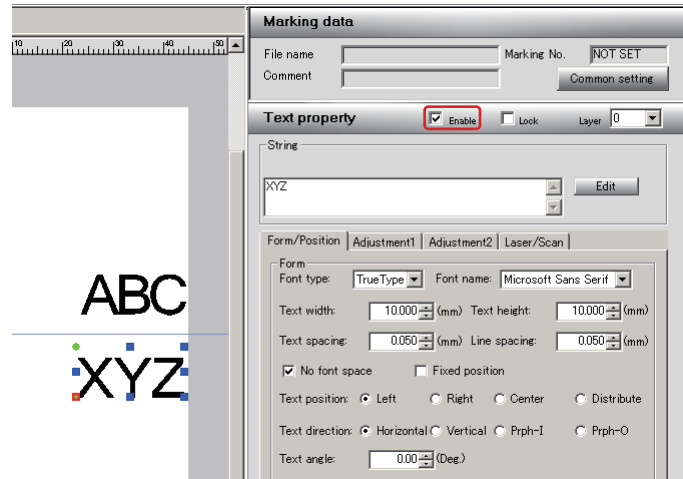

The specified block will now be displayed in light gray and will be set as non-marking target.

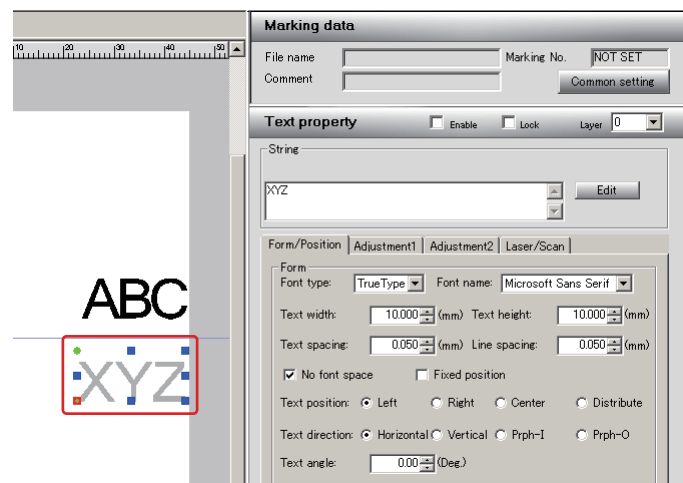

Additional Information

Data can still be edited for the non-marking target blocks.

■ Lock setting

Select the blocks to be locked, and select the [Lock] checkbox.

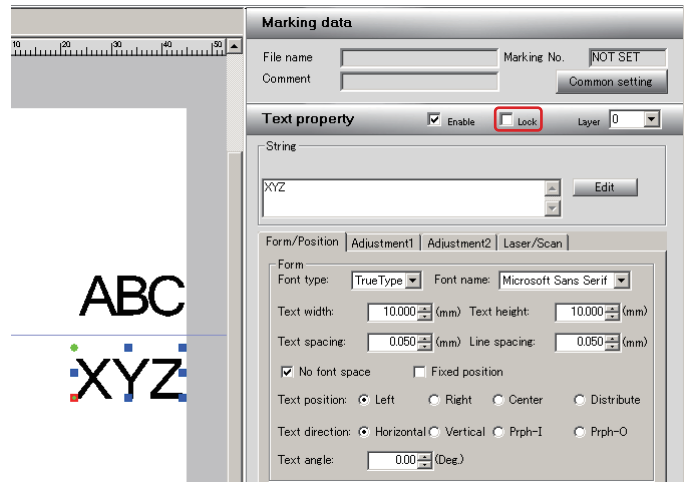

The specified block will now be displayed in light green and will be locked so that it cannot be moved.

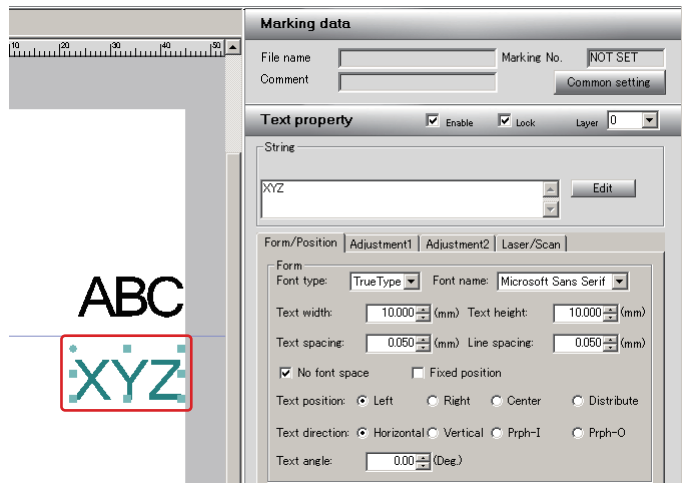

To unlock, clear the [Lock] check box.



Additional Information

- Select [Edit] - [Lock]/[Unlock] on the menu bar to specify the same setting.
- Unless set as non-marking target, even locked blocks are included for marking.

Layer Creation

Follow the procedure below when creating a layer on the sheet.
Up to 8 layers can be created on one sheet.

- 1 Click [Common setting] on the [Edit mode] screen.

[Common setting] is displayed.

The screenshot shows the software interface with the following elements:

- Top bar: 2012/03/14 11:37:10, Test, Operation
- Marking data section: File name, Marking No. (NOT SET), Comment, and a red-bordered button labeled 'Common setting'.
- Text property section: Enable (checked), Lock (unchecked), Layer (0), and a String input field with an Edit button.
- Form/Position section: Adjustment1, Adjustment2, Laser/Scan tabs.
- Form section: Font type (TrueType), Font name, Text width (15.000 mm), and Text height (15.000 mm).

- 2 Select the [Position] tab.

The screenshot shows the 'Common setting' dialog box with the following elements:

- Marking data section: File name, Marking No. (NOT SET), Comment, and a 'Common setting' button.
- Common setting section: Marking, Position (selected), Laser/Scan, Pallet, DFL tabs.
- Layer section: Layer count (1), Layer (0).
- Select layer diag: Plane (selected).
- X correction: 0.000 (mm)
- Y correction: 0.000 (mm)
- Z correction: 0.000 (mm)
- Theta X: 0.00 (Deg.)
- Theta Y: 0.00 (Deg.)
- Theta Z: 0.00 (Deg.)

- 3 Set the number of layers to be created in [Layer count].

The same number of [Layer] tabs as the number of layers to be created will be displayed.

Numbers in the tab indicate the layer number.

The screenshot shows the 'Common setting' dialog box with the following elements:

- Marking data section: File name, Marking No. (NOT SET), Comment, and a 'Common setting' button.
- Common setting section: Marking, Position, Laser/Scan (selected), Pallet, DFL tabs.
- Layer section: Layer count (3), Layer (0).
- Select layer diag: Plane (selected).
- X correction: 0.000 (mm)
- Y correction: 0.000 (mm)
- Z correction: 0.000 (mm)
- Theta X: 0.00 (Deg.)
- Theta Y: 0.00 (Deg.)
- Theta Z: 0.00 (Deg.)

4 Create the same number of blocks for marking as the number of layers.

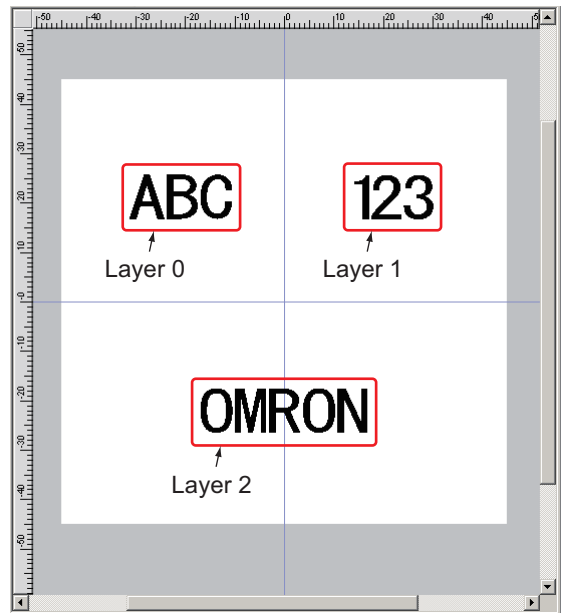

5 Select a block, and assign a layer number to the block in [Layer].

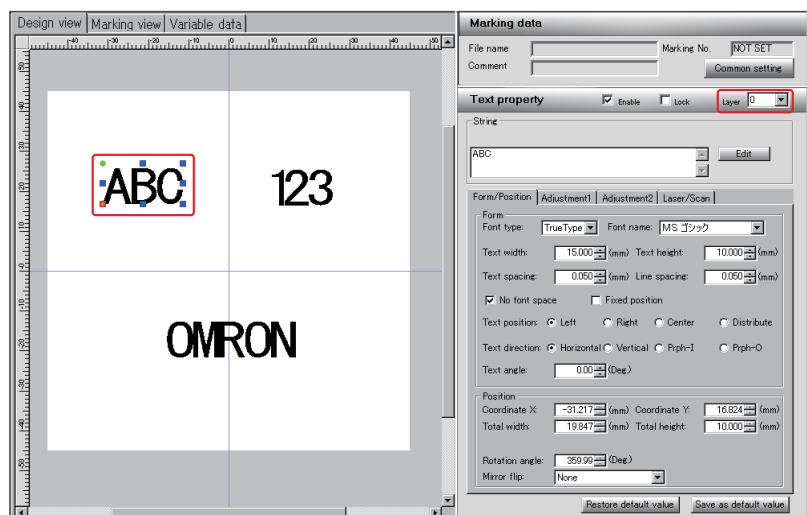

6 When necessary, select the layer number tab within the [Position] tab in [Common setting], select the layer shape, and perform the position correction for each layer or make the curve settings.

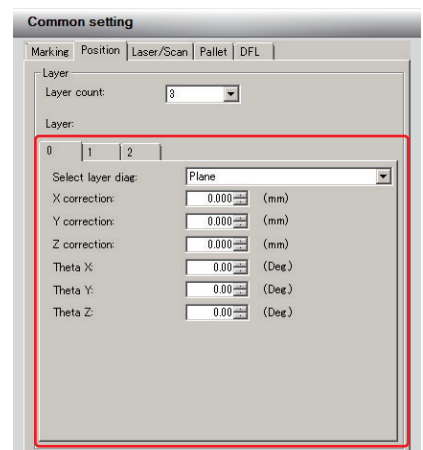

Switching Layer

When the marking data that creates the layer is displayed, you can change the marking image view between layers.

- 1** In [Layer], select the layer to be displayed on the sheet ("All" or "0" to "7").

The block that corresponds to the selected layer will be displayed on the sheet.



5

5.2 Part File Registration Function

Registers a single or multiple blocks to a single part file.

- 1 Upon specifying the blocks to be registered to a part file by specifying a range with the mouse or by selecting them with a left-click while holding down the [Ctrl] key on the keyboard, click [File] on the menu bar and select [Register part].

The [Register part] dialog box is displayed.

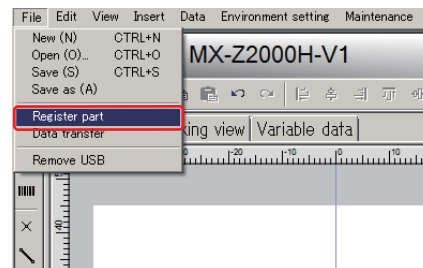

- 2 Enter a part file name in [Part file], a comment in [Comment], select the marking marker software version with [format], and then click [Save].

The part file will be saved.

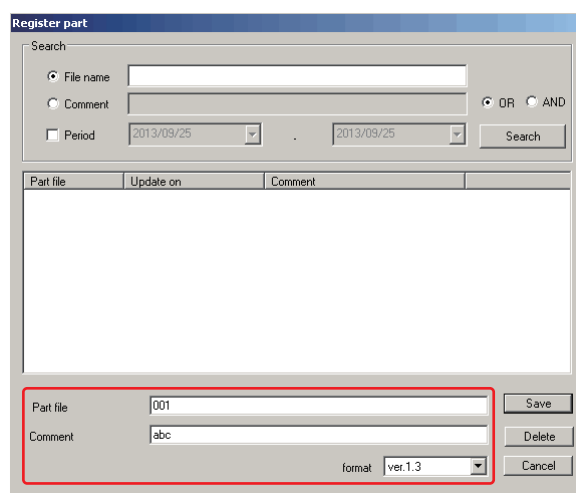

Additional Information

- Select a part file in [Register part] dialog box and click [Delete] to delete the selected part file.
- With the [Resister part] dialog box, you can search part file with the method described below.
 - Search with file name
 - Search with comments saved with the part file
 - Search with the date (period) of creation
 - Search with file name and the date (period) of creation
 - Search with comments and the date (period) of creation

You cannot select both [File name] and [Comment] as a search keyword at the same time.

In the [Search] box, select the item that you want to use for the search from above, enter the search keyword and/or period, and then click [search].

You can specify OR and AND conditions. When specifying multiple search keywords, separate the keywords with a comma "," or semicolon ";".

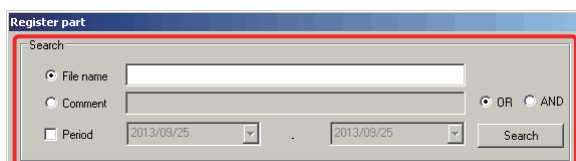

5.3 Block List Display Function

The blocks that were created are numbered to be managed individually by the marker software. This section explains the function to display the block list.

Block List

The block list is displayed.

- 1 Click [Data] on the menu bar, and then select [Block list].

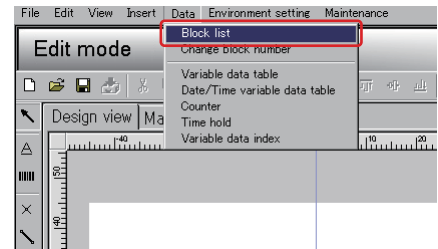

The [Block list] dialog box is displayed.

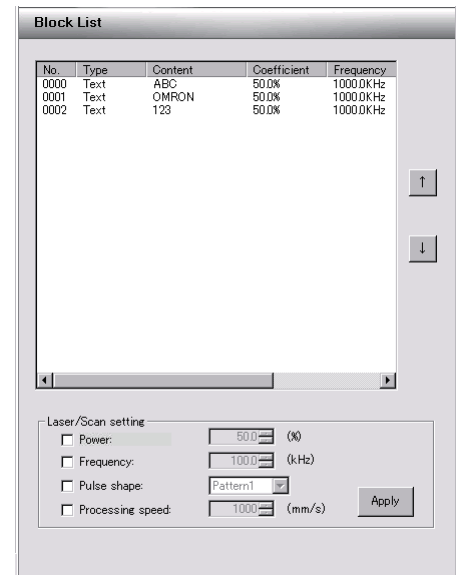

Additional Information

- You can also display the block list by clicking [Block list] on the [Edit mode] screen.



- When you select a block in the block list, the object on the drawing area will also be selected and the object can be selected from the list.

■ **Sorting the blocks displayed**

Select a block and click [↑]/ [↓] to move the block display position up/down by one.

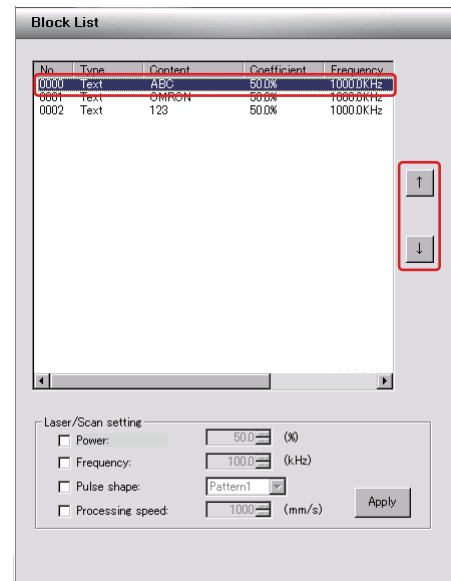

Additional Information

In an actual marking process in general (with no marking optimization, etc.), the block list is sorted from top down. Use this function to change the marking order.

■ **Deleting the block**

Select the block and click [Delete] key.

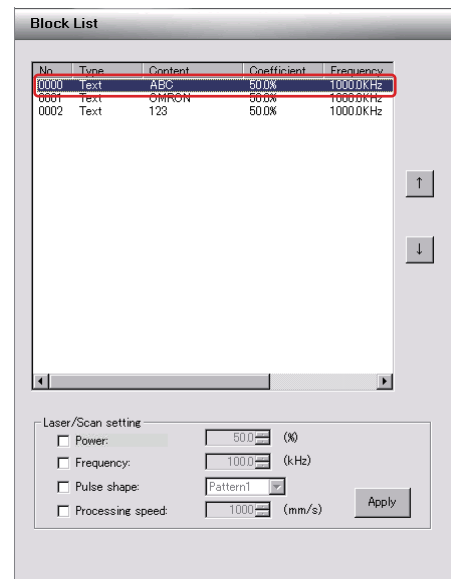

■ Laser/Scan settings for each block

Laser/Scan settings for marking can be made for each block in the block list.

- 1 Select the block (multiple selection allowed) and set each item for [Laser/Scan setting].

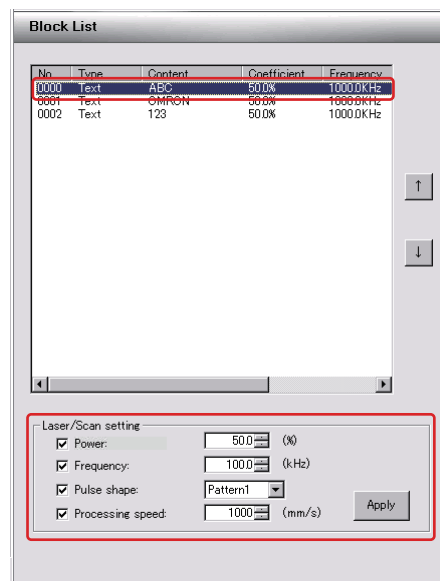

5



Additional Information

When you select a block, the object on the drawing area will also be selected.



Reference

The settings for [Laser/Scan setting] are the same as the settings for each block. For details, refer to the explanation of [Laser/Scan] tab settings for each block.

- 2 Click [Apply].
A message to confirm the settings to be saved is displayed..

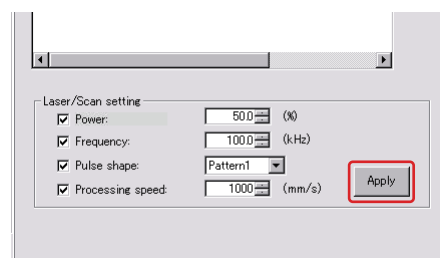

- 3 Click [Yes].

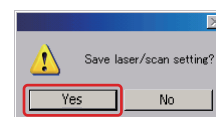

■ **Changing the block number**

The block number can be changed.

- 1 Click [Data] on the menu bar, and then select [Change block number].
The [Change block number] dialog box is displayed.

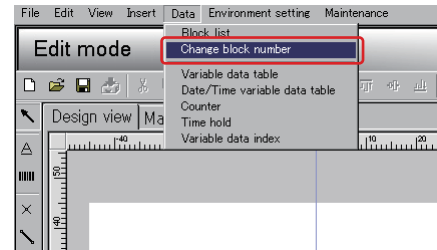

- 2 Select the block of which the block number is to be changed, and click [Change number].

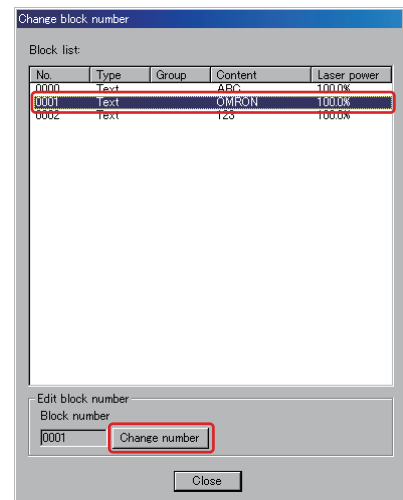

- 3 Set a new block number in [New block number], and click [OK].

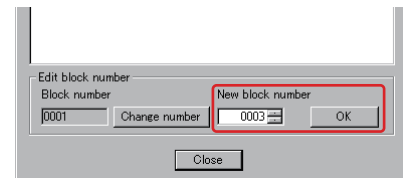

Additional Information

The following message will be displayed if an existing block number is set in [New block number].

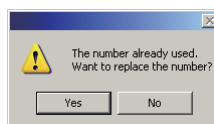

Click [Yes] to change the block number.

5.4 Variable Data Table Setting Function

When the text, image or graphic to be marked or processed needs to be frequently changed due to setup change, etc., the marking item can be quickly set up by registering it to a table (variable data table) that has been arranged beforehand and simply by specifying the index number (element number in the table) when you start marking.

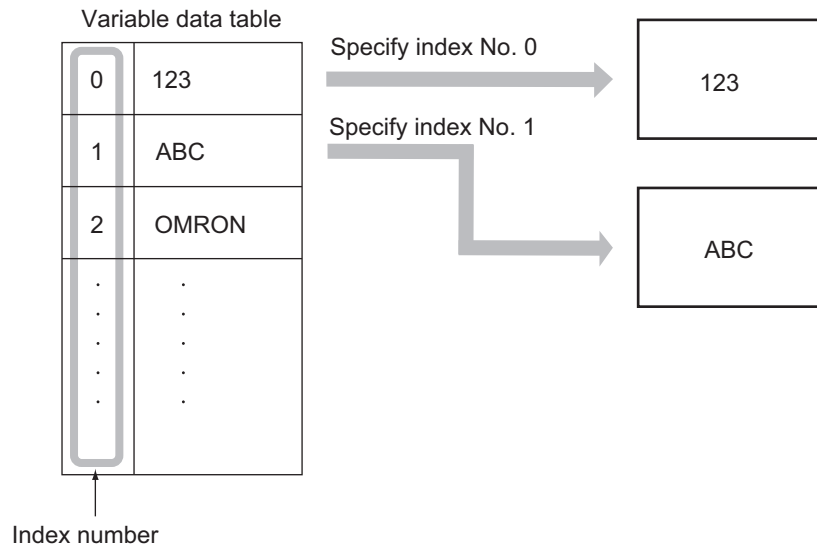

Up to 64 variable data tables can be registered each for the "string," "image" and "graphic" types (data table Nos. 0 to 63), and up to 256 elements can be registered per table (index Nos.0 to 255).

String table (Set the string.)

Data table No. 0		Data table No. 1		Data table No. 63	
0	123	0	456	0	
1	ABC	1	DEF	1	
2	OMRON	2	OMRON	2	
⋮		⋮		⋮	
⋮		⋮		⋮	
255		255		255	

Image table (Set the image file.)

Data table No. 0		Data table No. 1		Data table No. 63	
0	aaaaa.bmp	0	dddd.bmp	0	
1	bbbbb.bmp	1	eeeee.bmp	1	
2	ccccc.bmp	2	ffff.bmp	2	
⋮		⋮		⋮	
⋮		⋮		⋮	
255		255		255	

■ Variable data table counter link function

A counter can be set for a variable data table created and each time the current value of that counter changes, the character string/image/shape for the variable data table index number corresponding to the current value can be marked.

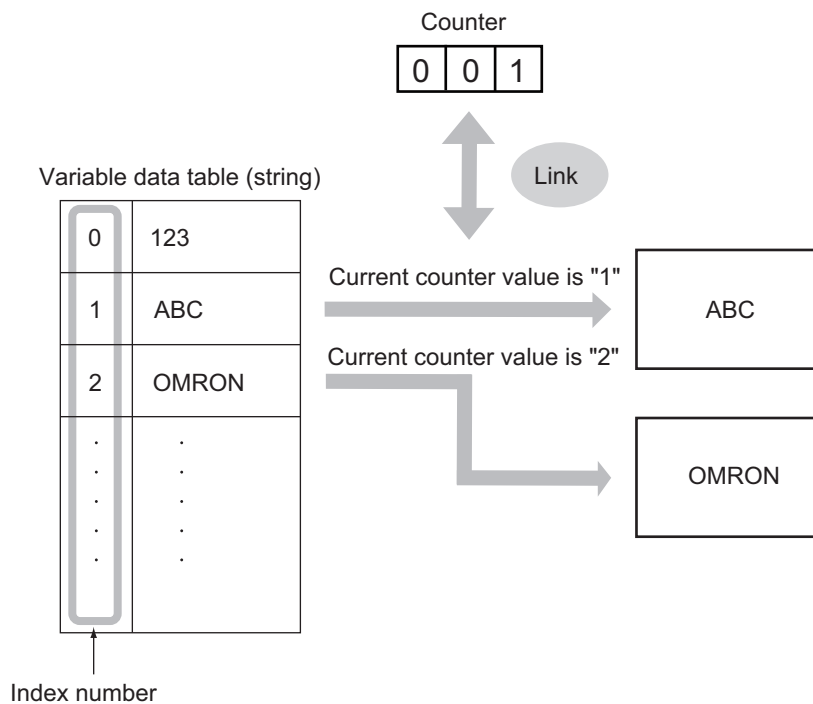

For example, in the figure above, when the current counter value becomes "1", the "ABC" for Index number 1 is marked, and when the current counter value becomes "2", the "OMRON" for Index number 2 is marked.



Reference

- "5.6 Counter Setting Function (page 5-45)"

Creating Variable Data Table

Create the variable data table.

- 1 Click [Data] on the menu bar, and then select [Variable data table].

The [Variable data table setting] dialog box is displayed.

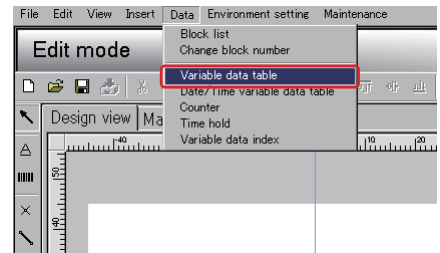

- 2 Select the tab of the table type to be set ([String table]/[Image table]/[Graphic table]).

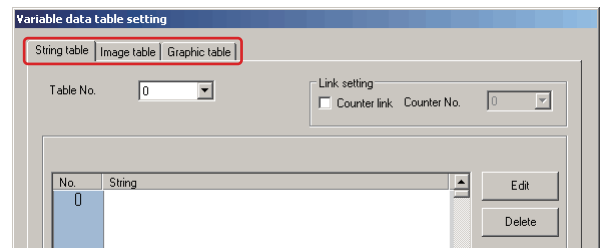

- 3 Specify the number of the table to be created in [Table No.].

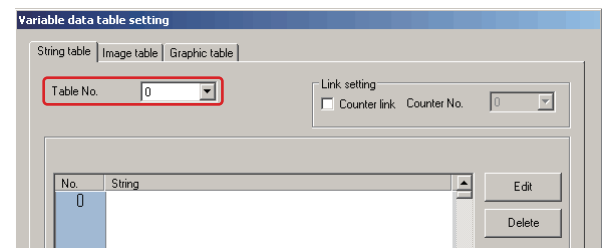

- 4 To link with a counter, check [Counter link] and select the counter number to link to.

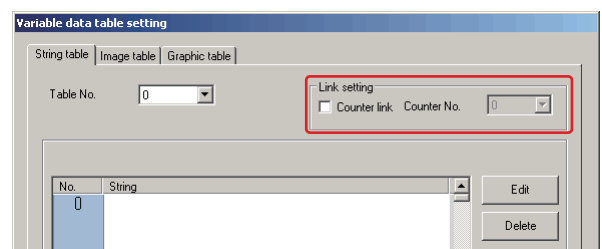

- 5 Select the text box for the index number for which a string or file name is to be set, and click [Edit].

The [Enter string] dialog box is displayed for a string table, and the [Enter file] dialog box for an image or graphic table.

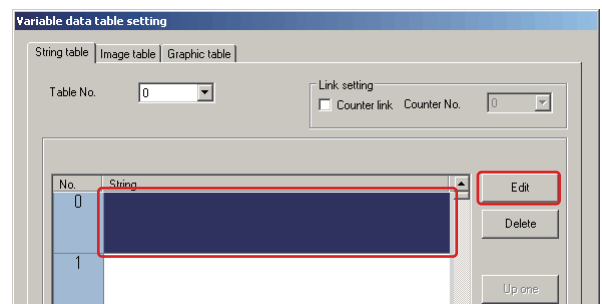

- 6 Enter a string in the text box in the case of a string table, or click [Browse] in the case of an image or graphic table to select a filename, and click [Setting]

The item specified is displayed in the text box for the index number.

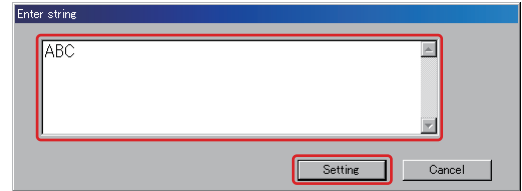

- 7 When the setting has been completed, click [OK].

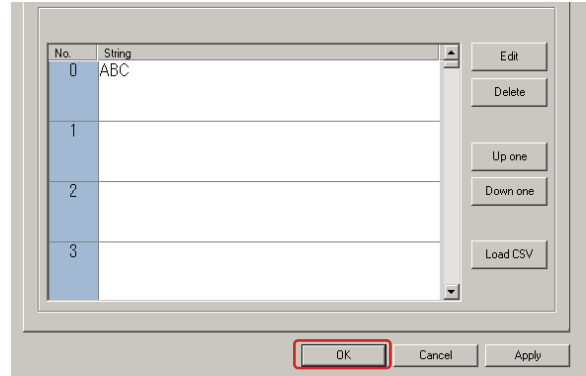

Additional Information

Click [Delete] in the [Variable data table setting] dialog box to delete the selected item. Click [Up one]/[Down one] to move the selected item above/below the index by one.

Setting Blocks Using the Variable Data Table

Follow the procedure below when using the items in the variable data table for blocks.

■ [Text] block

- 1 Click  on the block menu, or click [Insert] on the menu bar and then select [Text]. [Text property] is displayed.
- 2 Click [Edit]. The [Edit] dialog box is displayed.

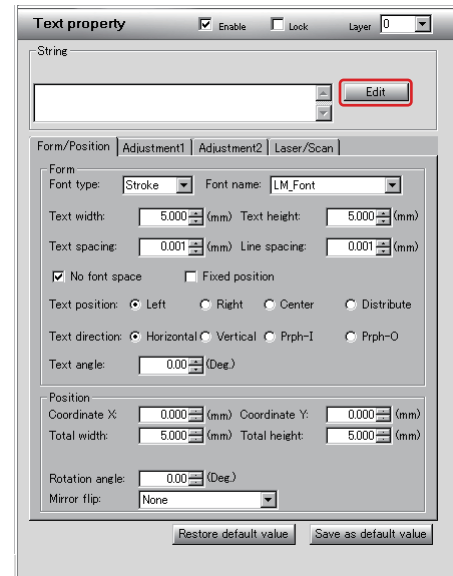

3 Select the [Variable data table] tab.

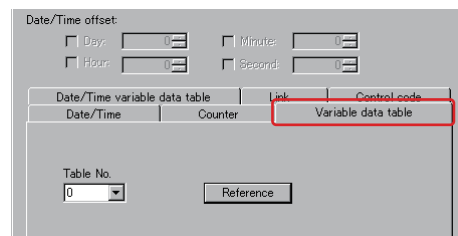

4 Specify the number of the data table in which the items to be marked are registered, and click [Add].

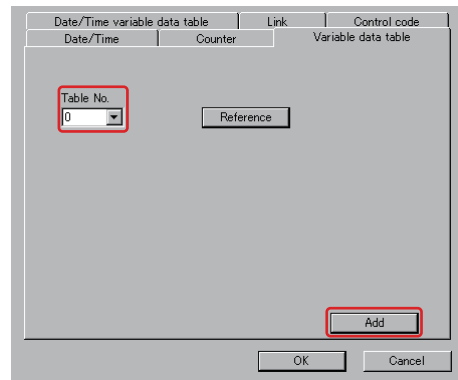

The display code for the variable data table is displayed in [Content].

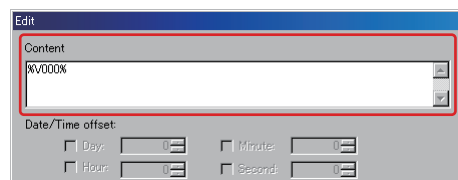

 **Reference**

- "A.6 List of Display Codes (page A-23)"

 **Additional Information**

Click [Browse] to display the [Variable data table setting] dialog box, in which the data table items can be viewed and edited.

5 Click [OK].

■ [Image] block/[Graphic] block

1 Click **BMP / GRAPH** on the block menu, or click **[Insert]** on the menu bar and then select **[Image]/[Graphic]**.
[Image property]/[Graphic property] is displayed.

2 Click **[Edit]**.
The [Select data] dialog box is displayed.

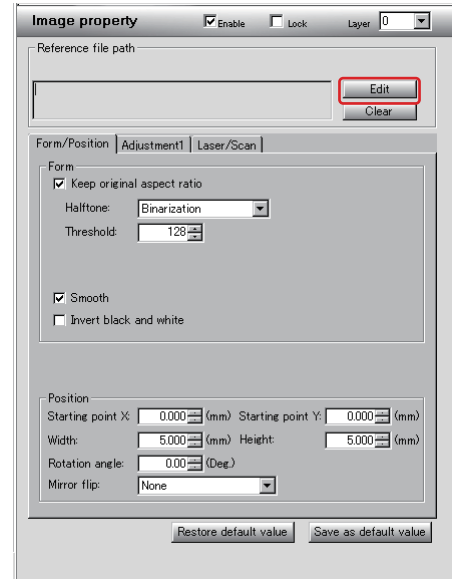

3 Select **[Select variable data]** and click **[OK]**.
[Select variable data] dialog box is displayed.

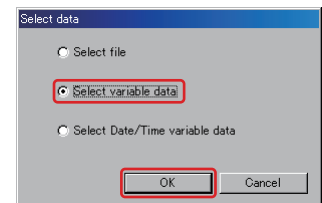

4 Specify the number of the data table to be marked, and click **[OK]**.

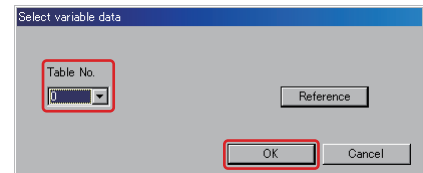

The display code of the variable data table is displayed in [Reference file path] of [Image property] or [Graphic property].

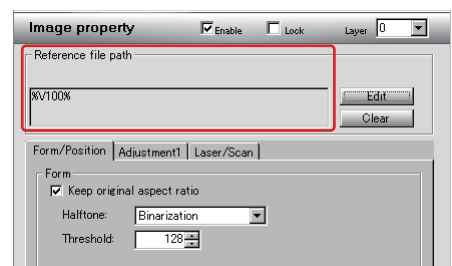

Reference

- "A.6 List of Display Codes (page A-23)"

Additional Information

Click **[Browse]** to display the [Variable data table setting] dialog box, in which the data table items can be viewed and edited.

5 Click [OK].

Changing Index Numbers

If a variable data table is used for the marking data blocks, the index numbers that are used can be viewed and changed.

(Use example)

Using a variable data table (string table) of table No. 0 in which string "123" is registered to index No. 0 and "ABC" to index No. 1 for [Text] block, change the index number to be used for marking of table No. 0 to 1 when it is set to 0.



Additional Information

When a new variable data table is created, the initial value of the index number of that table number is 0.

1 Display the sheet that includes the blocks that are using the variable data table.

In this example, the table No. 0 and index No. 0 content is displayed.

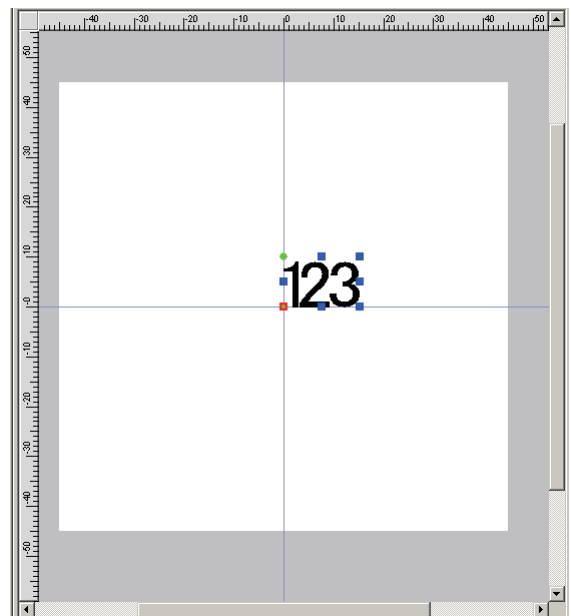

2 Click [Data] on the menu bar, and then select [Variable data index].

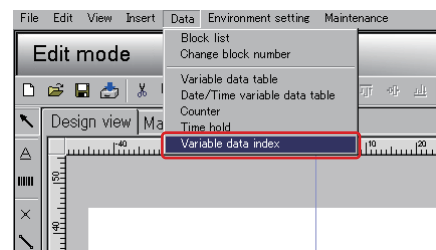

The [Variable data index setting] dialog box is displayed, and the index number to be used for marking is displayed in [Setting].

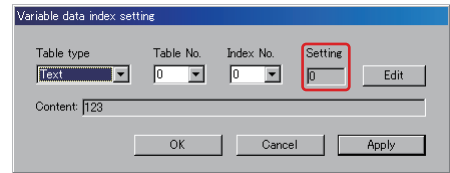

The index number to be used for marking can be set for each variable data table. If multiple variable data tables are used, the index number specified for each of the variable data tables is displayed in [Setting] when the [Table type] or [Table No.] is changed.

In [Content], you can also view the variable data table content (string or graphic/image file path) specified in [Table type], [Table No.] and [Index No.].

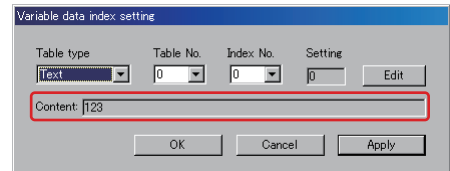

- 3 To change the index number, specify, in [Table type] and [Table No.], the variable data table for which the index number is to be changed, and the index number to be changed in [Index No.], and then click [Apply].

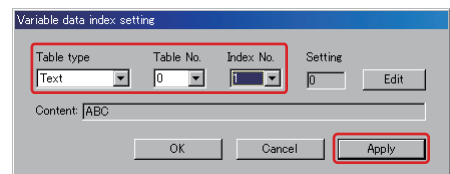

The new index number is displayed in [Setting].

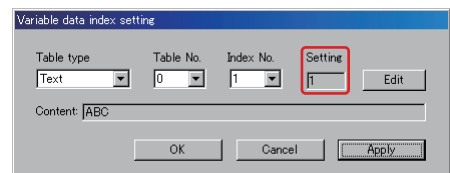

Additional Information

Click [Edit] to display the [Variable data table setting] dialog box and edit the variable data table.

- 4 Click [OK].

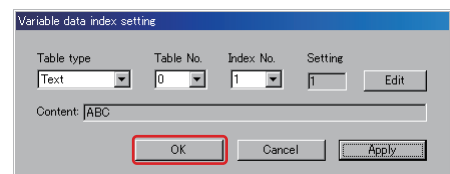

5 Click on a sheet.

The sheet display gets updated, and the variable data table content specified by the new index number is displayed.

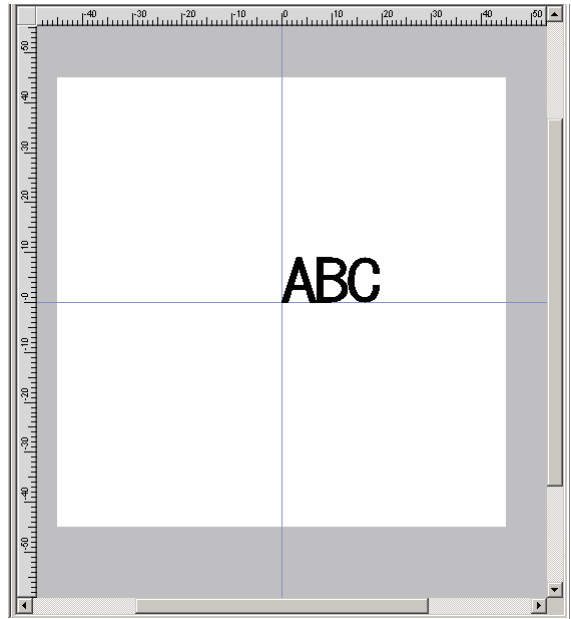

5

**Additional Information**

The index number can also be changed on the [Operation mode] screen. Select the [Variable data] tab and click [Setting] in [Variable data] to display the [Variable data index setting] dialog box, and perform the same operation as above. (Refer to "Monitoring Counter, Time Hold and Variable Data (page 4-10)")

Example of Creating Variable Data Table

Create the following variable data table.

String table

Data table No. 0

0	Sample1
1	Sample2
2	Sample3

Image table

Data table No. 0

0	sample1.bmp
1	sample2.bmp
2	sample3.bmp

■ Creating method

● Creating the string table

- 1 Click [Data] on the menu bar, and then select [Variable data table].

The [Variable data table setting] dialog box is displayed.

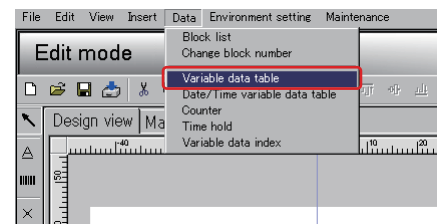

- 2 Select the [String table] tab.

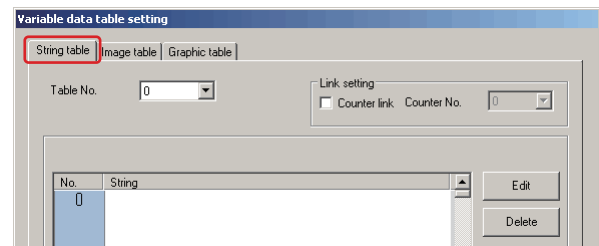

- 3 Select "0" under [Table No.].

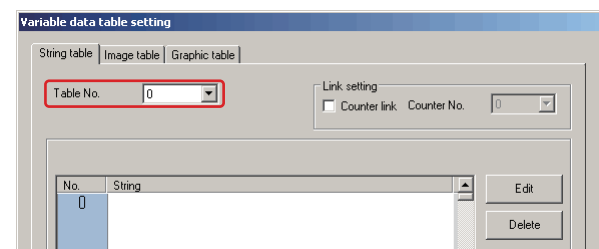

- 4 Select the text box of index No. 0, and click [Edit].

The [Enter string] dialog box is displayed.

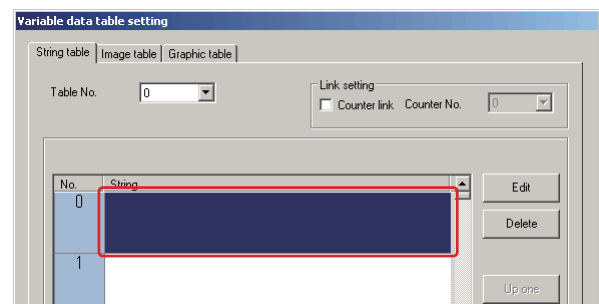

- 5** Enter "Sample1" in the text box, and click [Setting].
String "Sample1" will be set in index No. 0.

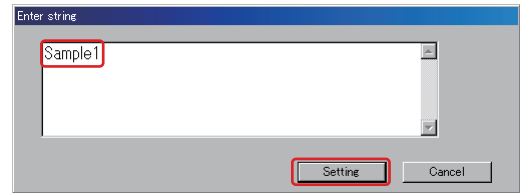

- 6** Select the text box of index No. 1, and click [Edit].
The [Enter string] dialog box is displayed.

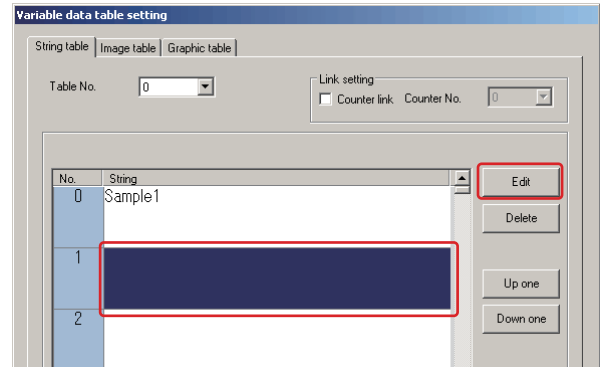

- 7** Enter "Sample2" in the text box, and click [Setting].
String "Sample2" will be set in index No. 1.

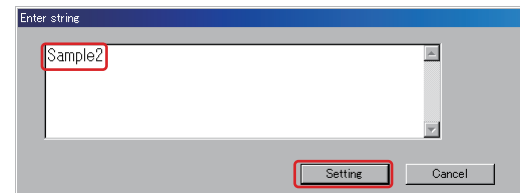

- 8** In the same manner, set the string "Sample3" in the text box of index No. 2.

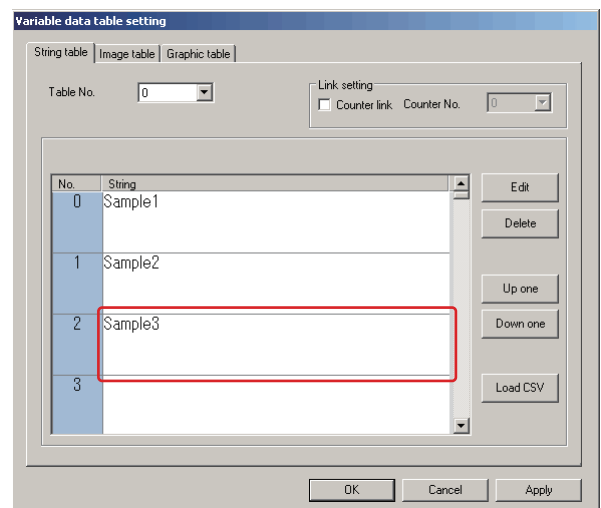

● **Creating the image table**

1 Select the [Image table] tab.

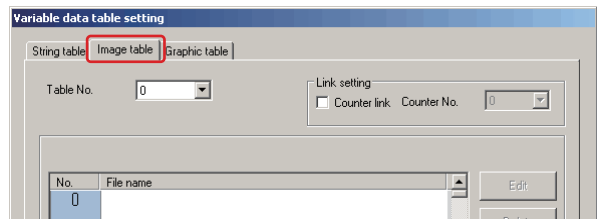

2 Select "0" under [Table No.].

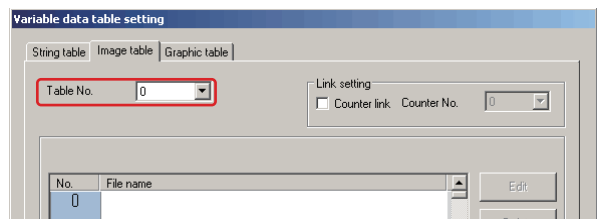

3 Select the text box of index No. 0, and click [Edit].

The [Enter file] dialog box is displayed.

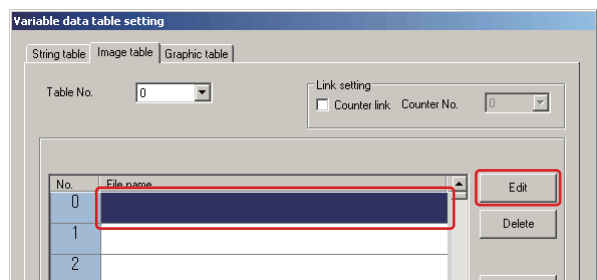

4 Click [Browse] and, in the [Pick image] dialog box, select an image file, "sample1.bmp," and then click [Open]. When the selected image file name is displayed in the [Enter file] dialog box, click [Setting]

The image file name, "sample1.bmp" will be set to index No. 0.

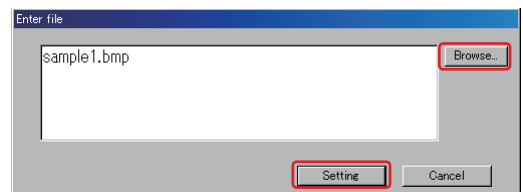

Additional Information

To display the list of file names in the [Pick image] or [Pick Graphic] dialog box, the image or graphic data must be installed on the marker software from USB memory, etc. in advance by clicking [File] on the menu bar and selecting [Data transfer]. (Refer to "■ Installing data to the system or offline editing software (page 1-10)".)

- 5** Select the text box of index No. 1, and click [Edit].

The [Enter file] dialog box is displayed.

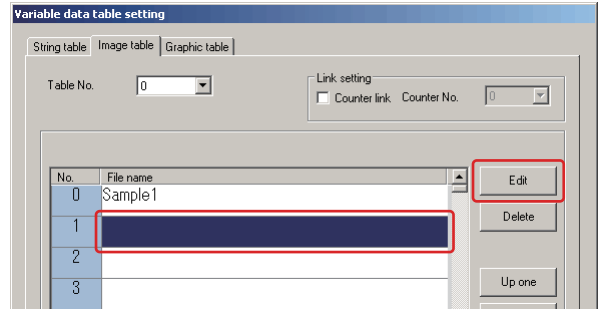

5

- 6** Click [Browse] and, in the same manner, select an image file, "sample2.bmp", and then click [Setting].

The image file name, "sample2.bmp" will be set to index No. 1.

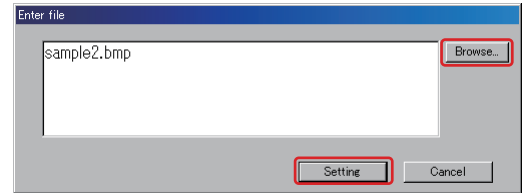

- 7** In the same manner, set the image file name, "sample3.bmp" in the text box of index No. 2.

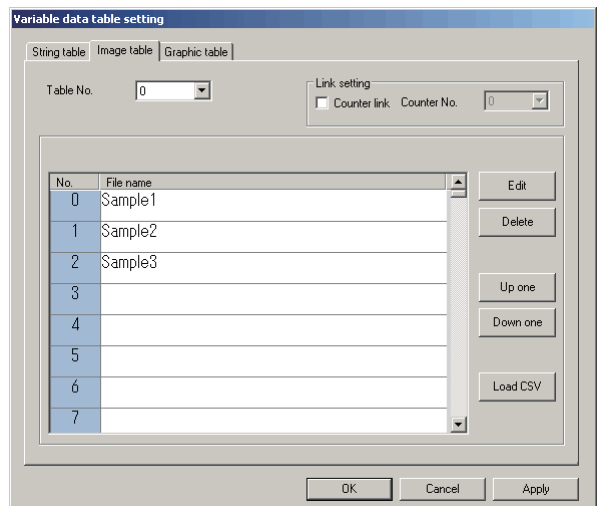

- 8** Click [OK].

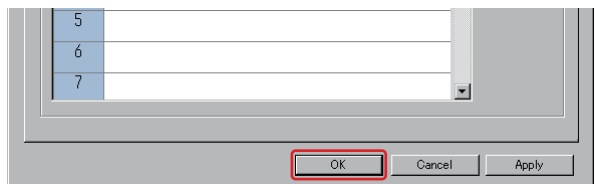

A variable data table is now created.

5.5 Date/Time Variable Data Table Setting Function

As in the case of the variable data table, when you are changing the text, image or graphic to be marked or processed by date or time, pre-register these items in the date/time variable data table, and when that day or time arrives, the item can be marked based on that.

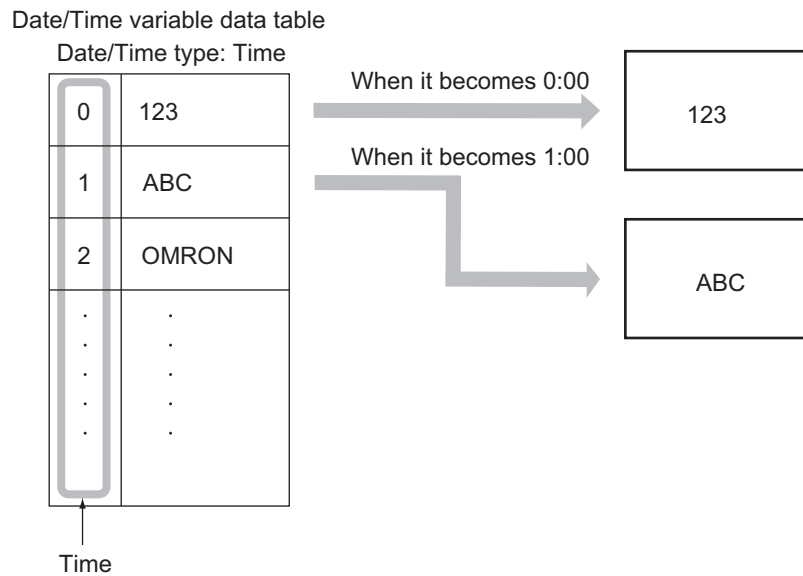

Precautions for Correct Use

When the date/time variable data table is set, the calculation time is affected depending on the marking data setting and screen operations may take longer than usual.

Up to 64 date/time variable data tables can be registered for "string," "image" and "graphic" types each, and data table can be created individually by the date/time type ("Month," "Day," "Hour," "Minutes," "Week day," "Week," and "Period").

String table (Set the string.)

Data table number

Month	Day	Period
1 Jan	1 1st	0:00 to 1:00
2 Feb	2 2nd	1:00 to 2:00
3 Mar	3 3rd	2:00 to 3:00
⋮	⋮	⋮
12	31	23:00 to 0:00

Data table No. 1

Month	Day	Period
1 January	1 1st	0:00 to 1:00
2 February	2 2nd	1:00 to 2:00
3 March	3 3rd	2:00 to 3:00
⋮	⋮	⋮
12	31	23:00 to 0:00

Image table (Set the image file.)

Data table No. 0

Month	Day	Period
1 jan.bmp	1 1st.bmp	0:00 to 1:00
2 feb.bmp	2 2nd.bmp	1:00 to 2:00
3 mar.bmp	3 3rd.bmp	2:00 to 3:00
⋮	⋮	⋮
12	31	23:00 to 0:00

Data table No. 1

Month	Day	Period
1 winter.bmp	1 first.bmp	0:00 to 1:00
2 winter.bmp	2 second.bmp	1:00 to 2:00
3 spring.bmp	3 third.bmp	2:00 to 3:00
⋮	⋮	⋮
12	31	23:00 to 0:00

Creating Date/Time Variable Data Table

Create the date/time variable data table.

- 1 Click [Data] on the menu bar, and then select [Date/Time variable data table].
The [Date/Time variable data table set.] dialog box is displayed.

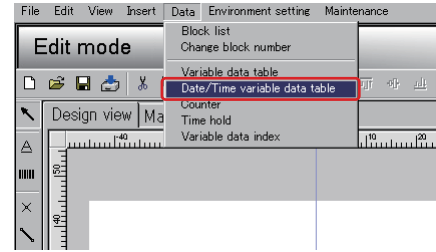

- 2 Select the tab of the table type to be set ([String table]/[Image table]/[Graphic table]).

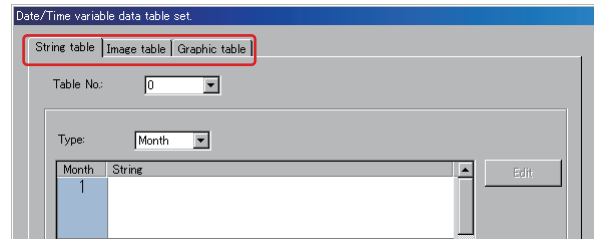

- 3 Specify the number of the table to be set in [Table No.].

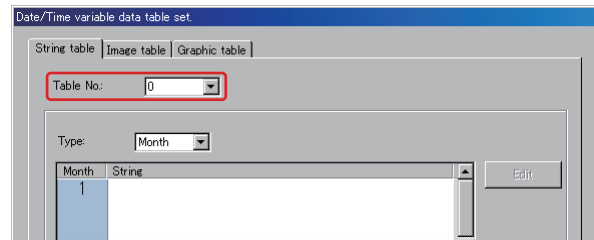

- 4 Set the date/time type to be set in [Type].
The type can be set to "Month", "Day", "Hour", "Minute", "Week day", "Week" or "Period."

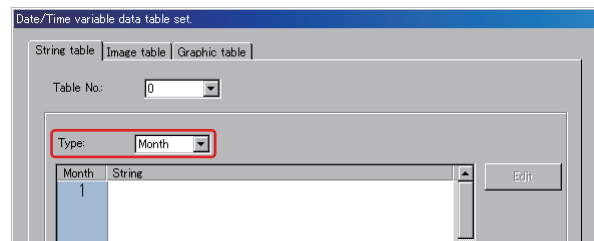

- 5 Select the text box for the index number for which a string or file name is to be set, and click [Edit].
The [Enter string] dialog box is displayed for a string table, and the [Enter file] dialog box for an image or graphic table.

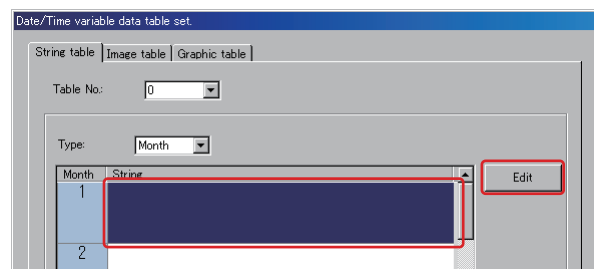

- 6** Enter a string in the text box in the case of a string table, or click [Browse] in the case of an image or graphic table to select a filename, and click [Setting].

The item specified is displayed in the text box for the index number.

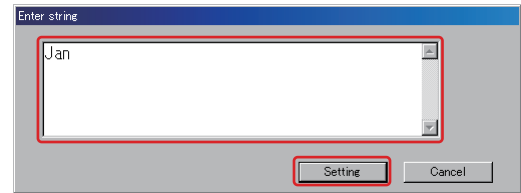

- 7** When the setting has been completed, click [OK].

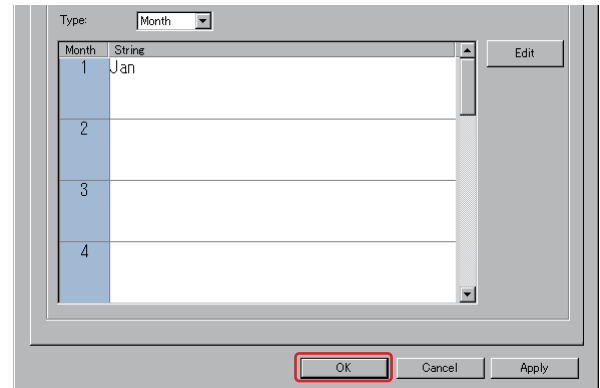

■ Setting the period

When the date/time type was set to "Period" in step 4, set the period based on the following procedure.

- [1]** Select the text box for the index number for which a string or file name is to be set, and click [Edit].

The [Period] dialog box is displayed.

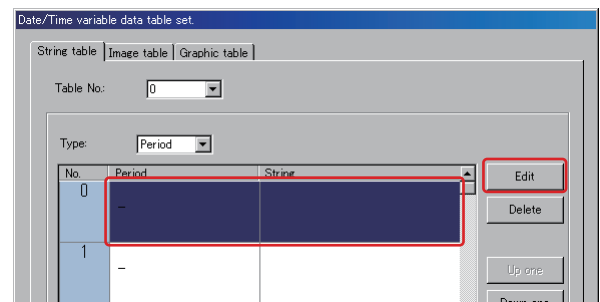

Additional Information

Click [Delete] to delete the selected item when the date/time type is set to "Period" in the [Date/Time variable data table set.] dialog box. Click [Up one]/[Down one] to move the selected item up or down by one.

[2] Under [Period type], select the period.

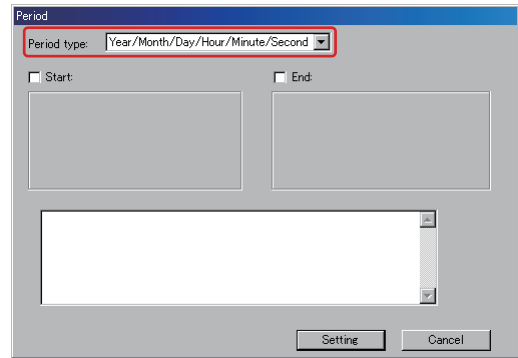

[3] Select the checkbox for [Start] or [End], and set the start date/time or end date/time.

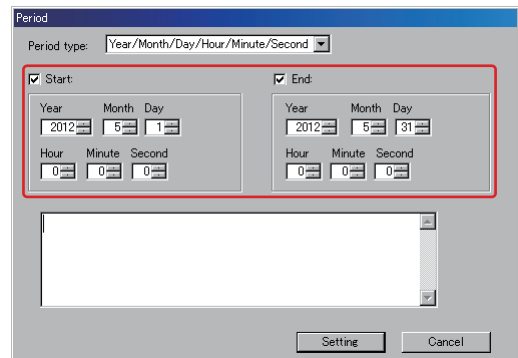

[4] Enter a string or a file name in the text box, and click [Setting].

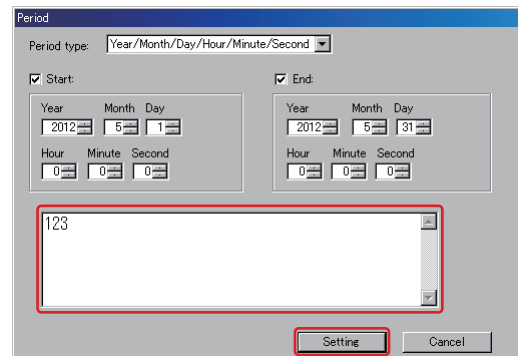

Setting Blocks Using the Date/Time Variable Data Table

Follow the procedure below when using the items in the date/time variable data table for blocks.

■ [Text] block

- 1 Click **A** on the block menu, or click [Insert] on the menu bar and then select [Text].
[Text property] is displayed.
- 2 Click [Edit].
The [Edit] dialog box is displayed.

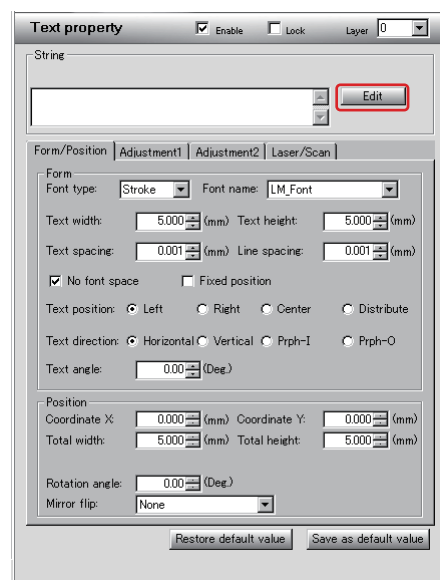

- 3 Select the [Date/Time variable data table] tab.

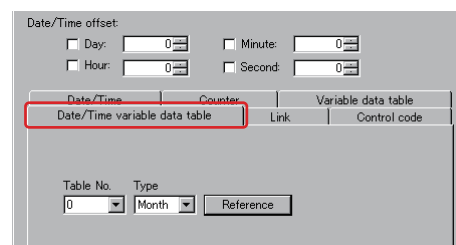

- 4 Specify the number of the table to be marked and the date/time type, and click [Add].

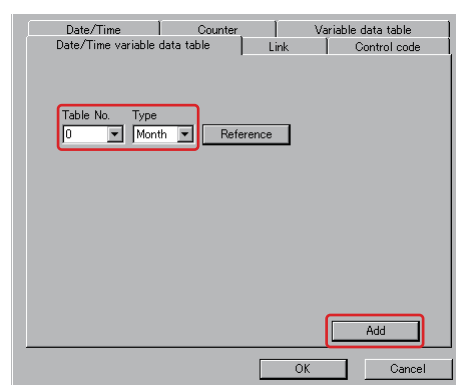

The display code for the date/time variable data table is displayed in [Content].

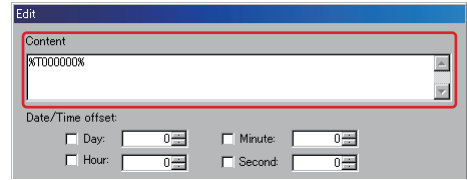

Reference

- "A.6 List of Display Codes (page A-23)"



Additional Information

Click [Reference] to display the [Date/Time variable data table set.] dialog box, in which the data table items can be viewed and edited.

5 Click [OK].

■ [Image] block/[Graphic] block

1 Click **BMP / GRPH** on the block menu, or click [Insert] on the menu bar and then select [Image]/[Graphic].
[Image property]/[Graphic property] is displayed.

2 Click [Edit].
The [Select data] dialog box is displayed.

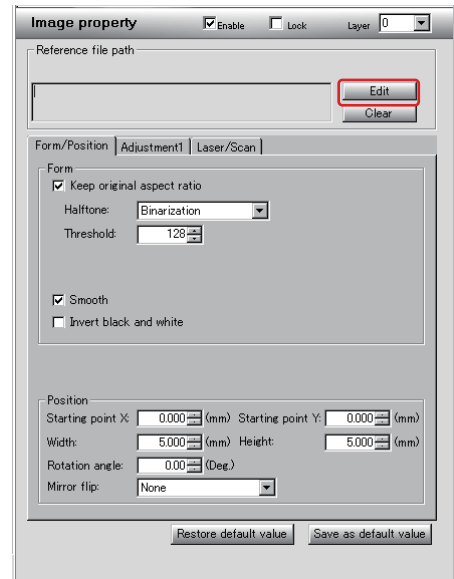

3 Select [Select Date/Time variable data] and click [OK].

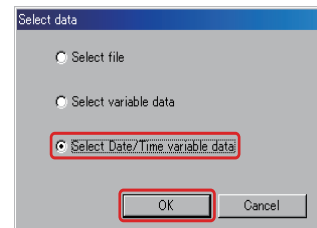

- 4 Specify the number of the data table to be marked and the index number, and click [OK].**

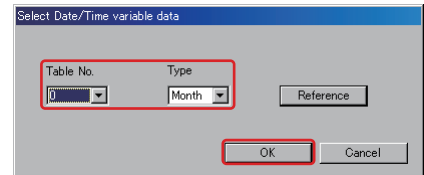

The display code for the date/time variable data table is displayed in [Reference file path].

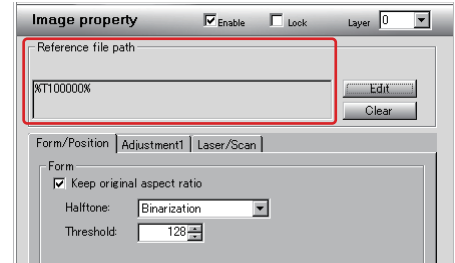

Reference

- "A.6 List of Display Codes (page A-23)"

Additional Information

Click [Reference] to display the [Date/Time variable data table set.] dialog box dialog box, in which the data table items can be viewed and edited.

Example of Creating Date/Time Variable Data Table

Create the following date/time variable data table.

String table
Data table No. 0

"Day" table		"Period" table	
1	Sample1	0:00 to 1:00	Sample4
2	Sample2	1:00 to 2:00	Sample5
3	Sample3	2:00 to 3:00	Sample6

Image table
Data table No. 0

"Month" table	
1	sample1.bmp
2	sample2.bmp
3	sample3.bmp

■ Creating method

● Creating the string table

◆ Creating the "Day" table

- 1 Click [Data] on the menu bar, and then select [Date/Time variable data table].
The [Date/Time variable data table set.] dialog box is displayed.

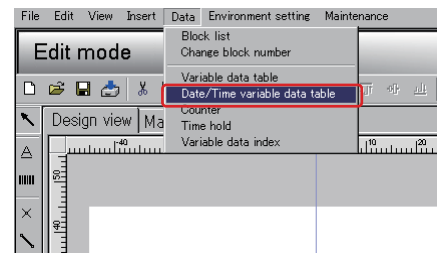

- 2 Select the [String table] tab.

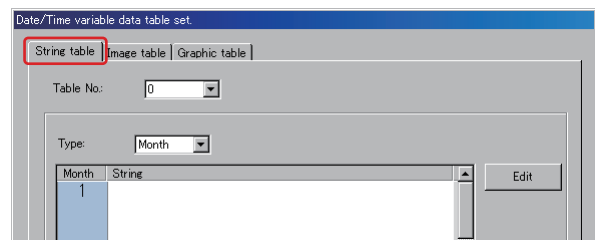

- 3 Select "0" under [Table No.]

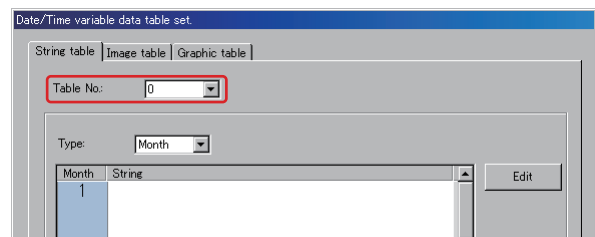

- 4 Select "Day" under [Type].

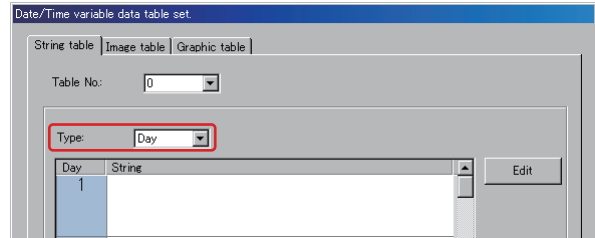

- 5 Select the text box of the "1," and click [Edit].

The [Enter string] dialog box is displayed.

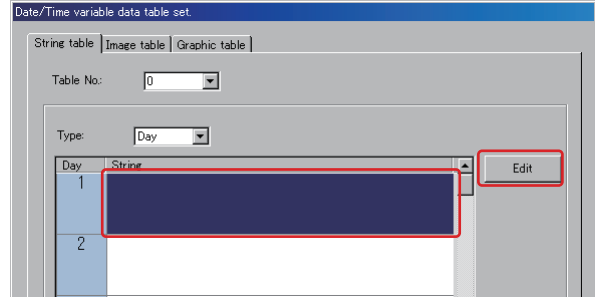

- 6 Enter "Sample1" in the text box, and click [Setting].

String "Sample1" will be set in "1."

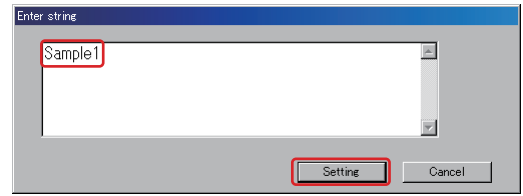

- 7 Select the text box of the "2," and click [Edit].

The [Enter string] dialog box is displayed.

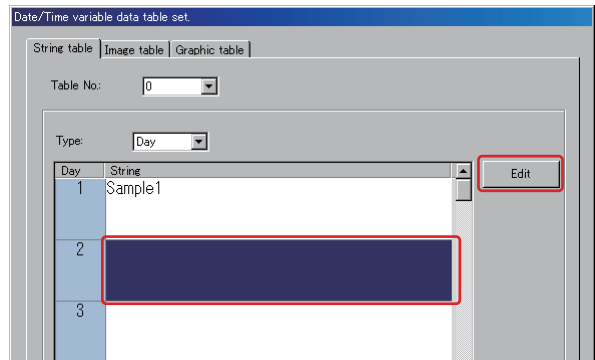

- 8 Enter "Sample2" in the text box, and click [Setting].

String "Sample2" will be set in "2."

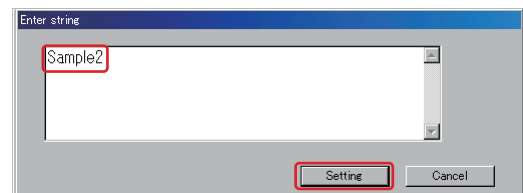

- 9 In the same manner, set the string "Sample3" in the text box of index "3."

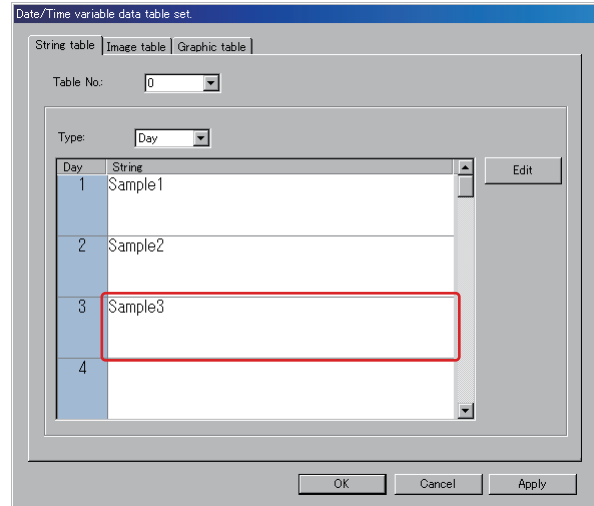

♦ Creating the "Period" table

- 1 Select "Period" under [Type].

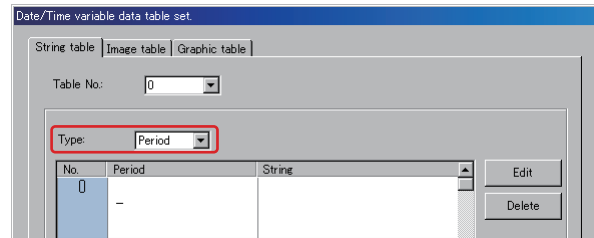

- 2 Select the text box of No. 0, and click [Edit].
The [Period] dialog box is displayed.

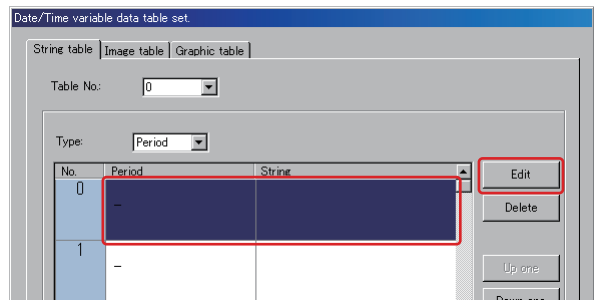

- 3 Select "Hour" under [Period type].

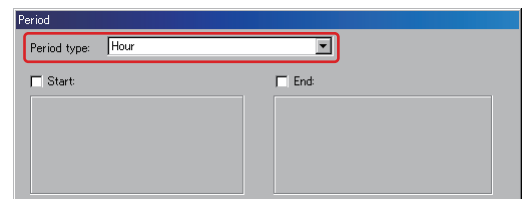

- 4 Select the [Start] checkbox, and set the start time to "0" in "Hour".

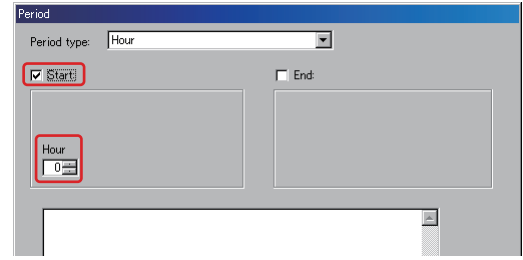

- 5 Select the [End] checkbox, and set the end time to "1" in "Hour".

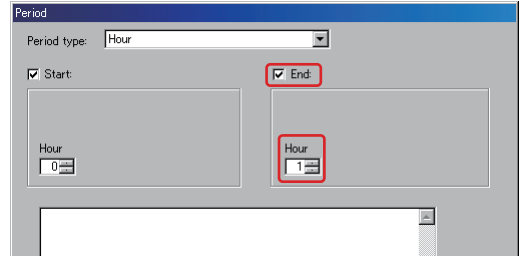

- 6 Enter "Sample4" in the text box, and click [Setting].
Period "00 to 01" (hour) and string "Sample4" will be set for No. 0.

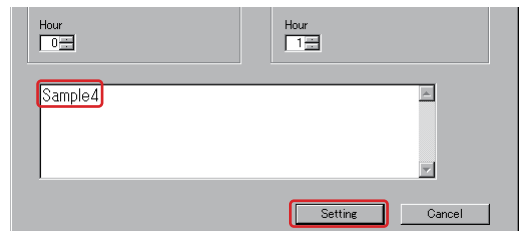

- 7 Select the text box of No. 1, and click [Edit].
The [Period] dialog box is displayed.

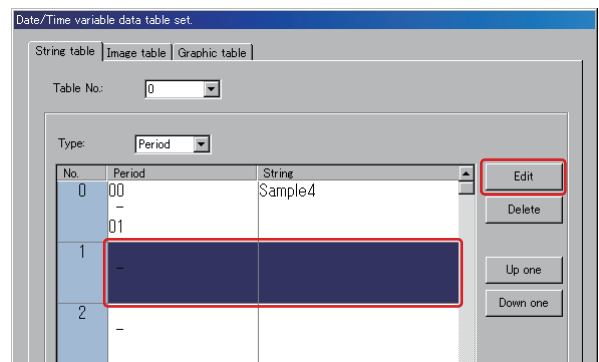

- 8 Select "Hour" under [Period type].

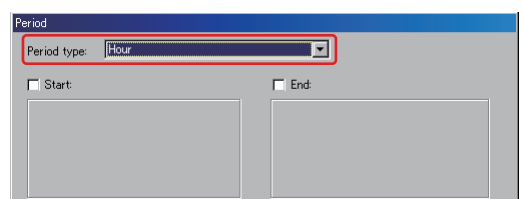

- 9 Select the [Start] checkbox, and set the start time to "1" in "Hour".

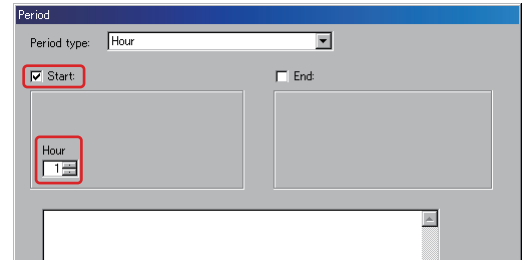

- 10 Select the [End] checkbox, and set the end time to "2" in "Hour".

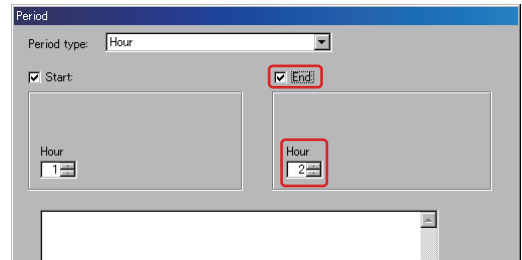

- 11 Enter "Sample5" in the text box, and click [Setting].
Period "01 to 02" (hour) and string "Sample5" will be set for No. 1.

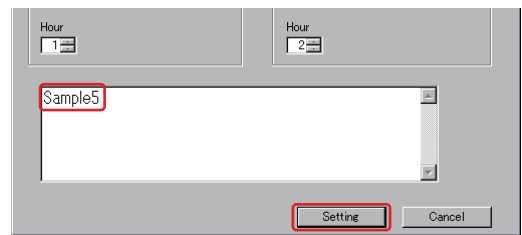

- 12 In the same manner, set the period "02 to 03" and string "Sample6" in the No. 3 text box.

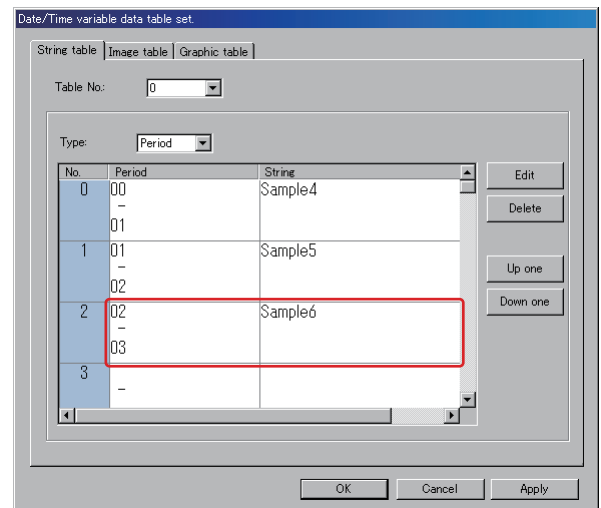

- **Creating the image table**

1 Select the [Image table] tab.

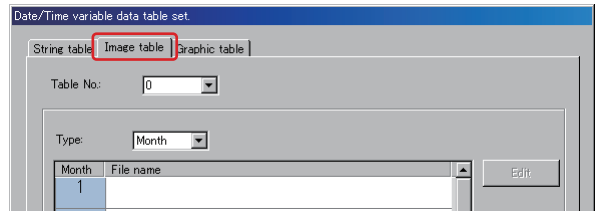

5

2 Select [0] under [Table No.]

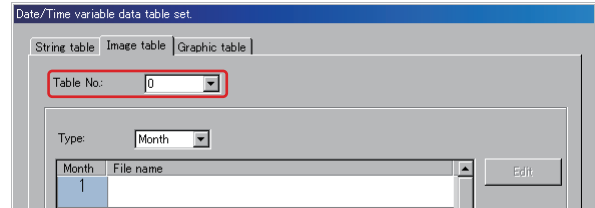

3 Select "Month" under [Type].

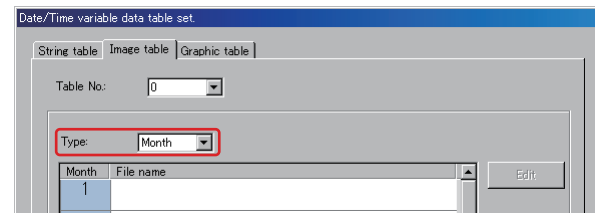

4 Select the text box of the "1," and click [Edit].
The [Enter file] dialog box is displayed.

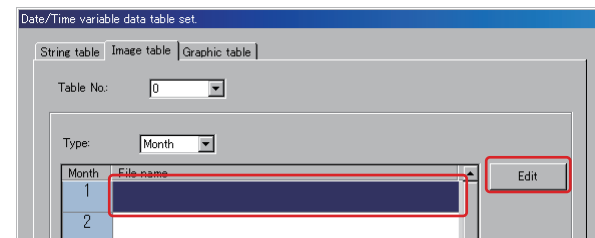

5 Click [Browse] and, in the [Pick image] dialog box, select an image file, "Sample1.bmp," and then click [Open]. When the selected image file name is displayed in the [Enter file] dialog box, click [Setting.]

The image file name, "Sample1.bmp" will be set to "1."

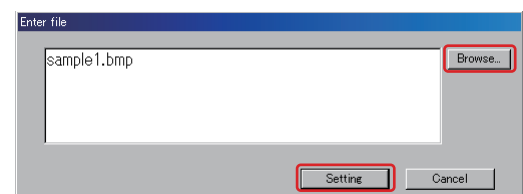



Additional Information

To display the list of file names in the [Pick image] or [Pick Graphic] dialog box, the image or graphic data must be installed on the marker software from USB memory, etc. in advance by clicking [File] on the menu bar and selecting [Data transfer]. (Refer to "■ Installing data to the system or offline editing software (page 1-10)")

- 6 Select the "2" text box, and click [Edit].**
The [Enter file] dialog box is displayed.

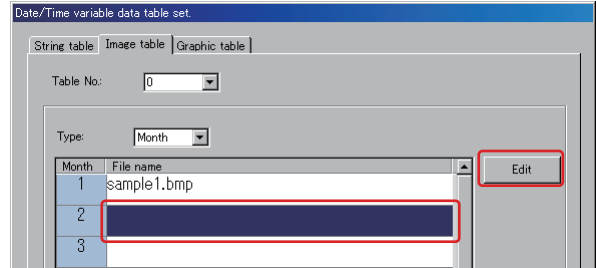

- 7 Click [Browse] and, in the same manner, select an image file, "Sample2.bmp," and then click [Setting]**
The image file name, "Sample2.bmp" will be set to "2."

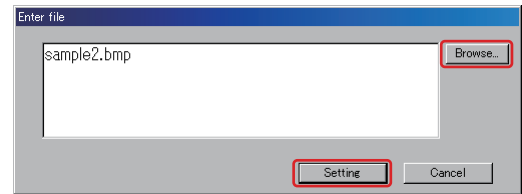

- 8 In the same manner, set the image file name, "sample3.bmp" in the text box of "3."**

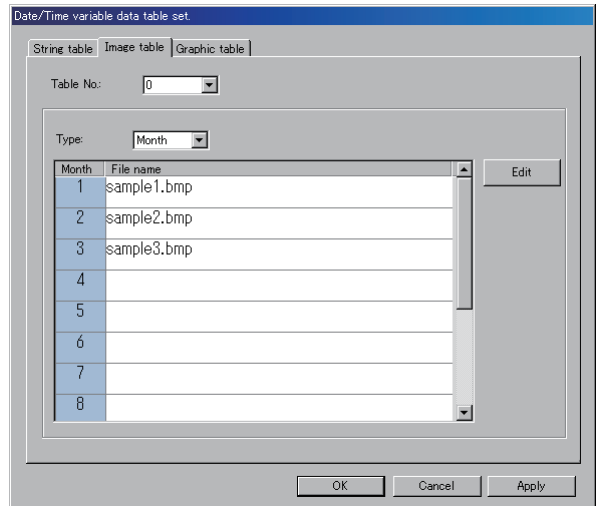

- 9 Click [OK].**

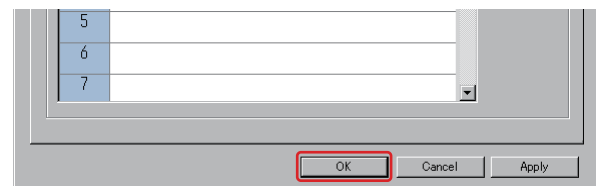

A date/time variable data table is now created.

5.6 Counter Setting Function

Set the counter for marking the counter.

- 1 Click [Data] on the menu bar, and then select [Counter].

The [Counter setting] dialog box is displayed.

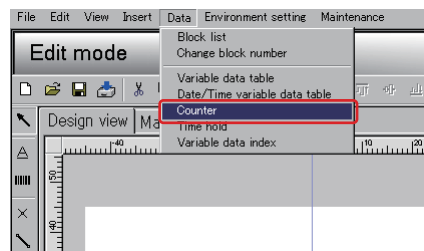

5

Additional Information

When creating a text block, the same dialog box can be displayed by clicking [Counter setting] under the [Counter] tab in the [Edit] dialog box. The counter can be set on either screen.

- 2 Select a new counter number or the number to be edited in [Counter No.], and set each item.

Refer to "■ Setting (page 5-46)"

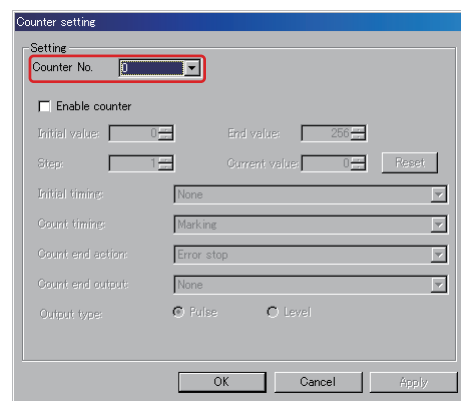

- 3 When the setting has been completed, click [OK].

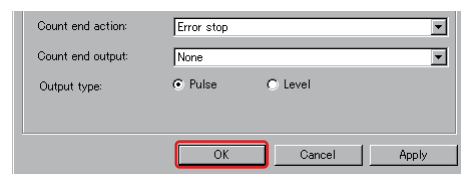

Additional Information

A counter can be linked to a variable data table to mark the data for the variable data table index number corresponding to the current counter value. (Refer to "5.4 Variable Data Table Setting Function (page 5-17)").

■ Setting

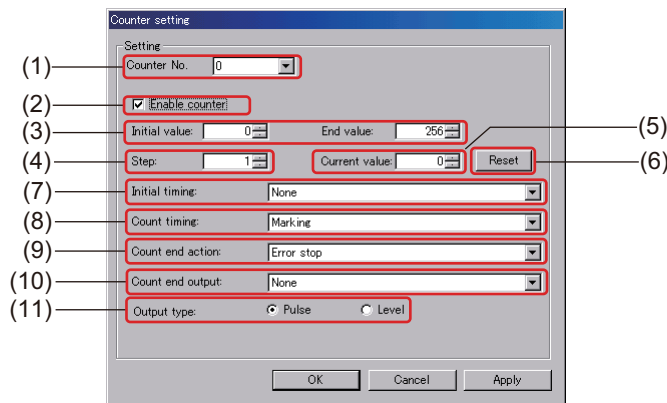

(1) Counter No.

Selects the counter number used for setting.

- Counter 0 to 7: Marking data counter (Individual)
- Counter 8 to 15: System counter (Common)

Data transfer is possible with system counter.

Use system counter if sharing the counter among marking data and other devices.

(2) Enable counter

This checkbox is selected to enable the counter displayed in "(1) Counter No."

(3) Initial value/End value

Sets the initial value (start value) and the end value of the counter.

The counting up/down type is also determined based on the value set here.

- Initial value < End value: Count up
- Initial value > End value: Count down

(4) Step

Sets the step value (variable range) per 1 count.

(5) Current value

The current counter value is displayed.

The value displayed changes based on the count up/down.

(6) [Reset]

Changes "(5) Current value" to the same value as "(3) Initial value."

(7) Initial timing

Sets the timing to initialize (reset) the counter.

When initialized, the initial counter value is restored.

Item	Description
Start marking	The counter is initialized every time marking is started.
New sheet	When [Common setting] - [Continuous count] is set, the counter is initialized every time a sheet is completed.
Power on	The counter is initialized when the system is started by turning ON the system power supply.
None	The counter is not initialized.
Change marking data	The counter is initialized every time the marking data is changed.

(8) Count timing

Sets the timing for counting.

Item	Description
Marking	Counting is executed every time marking is started.
Sheet	Counting is executed every time the sheet to be marked changes.
Cell	Counting is executed every time the cell to be marked changes in pallet marking.
Command change only	Counting is executed only when I/O command, "Count up/Count down" is entered on the input terminal block of the system or when the "Count up" command is received via serial communication.

**Reference**

For details on I/O command, refer to:

- "Fiber Laser Marker MX-Z2000H-V1 series Setup Manual" (Z415)

(9) Count end action

Sets the operation to be performed when the counter reaches the end value in count up/count down.

Item	Description
Error stop	Treats it as abnormality and stops the counter operation and puts the system in an error status.
Stop counter, resume at initial value.	Stops the count up/count down operation by the counter, and resumes marking at the initial value.
Stop counter, resume at end value.	Stops the count up/count down operation by the counter, and resumes marking at the end value.
Auto-loop	Returns to the initial value, and resumes count up/count down until a stop command is issued.

(10) Count end output

When the counter reaches the end value, selects from which terminal the [COUNT END] (counter end output) signal output from the system should be output.

Item	Description
None	Signal is not output.
A	Signal is output from the [COUNT END] (counter end output _A) terminal.
B	Signal is output from the [COUNT END] (counter end output _B) terminal.
C	Signal is output from the [COUNT END] (counter end output _C) terminal.
D	Signal is output from the [COUNT END] (counter end output _D) terminal.

(11) Output type

Selects the output type when [COUNT END] output is enabled in "(9) Count end output."

Item	Description
Pulse	Outputs the pulse signals, only once, of the width set in [I/O set.] (Refer to "I/O Setting (page 6-2)") when the counter reaches the end value.
Level	The level is set to ON when the counter reaches the end value.

**Reference**

For details on [COUNT END] (counter end output), refer to:

- "Fiber Laser Marker MX-Z2000H-V1 series Setup Manual" (Z415)

5.7 Time Hold Calculation Function

Time hold (time shifting) can be performed at the date or time specified in date/time marking.
Marking is performed based on the date/time set here.

- 1 Click [Data] on the menu bar, and then select [Time hold].

The [Time hold setting] dialog box is displayed.

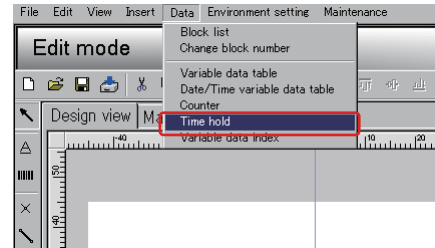

- 2 Select [ON].

The current date/time is displayed in [Set Date/Time].

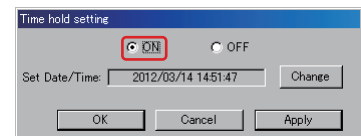

- 3 Click [Change].

The [Date/Time setting] dialog box is displayed.

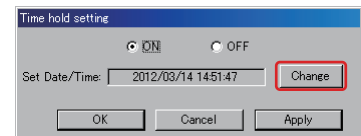

- 4 Set the date and time for time hold, and click [OK].

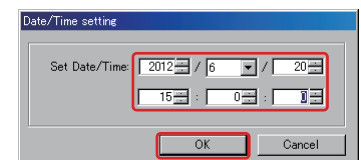

- 5 Click [OK].

The time hold time will be set.

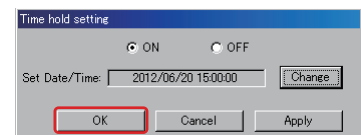

■ Cancelling the time hold setting

Select [OFF] in the [Time hold setting] dialog box and click [OK].

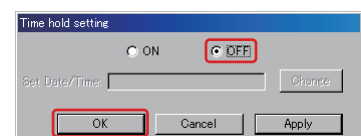

5.8 Marking Time Calculation Function

You can calculate and display the required amount of time between the start and end of marking.

- 1 Click [View] on the menu bar, and then select [Calculate marking time].
The [Calculate marking time] dialog box is displayed, and the total distance of the laser and the required marking time are calculated and displayed.

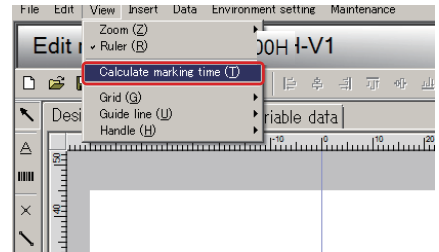

- 2 Click [Close] upon checking the dialog box.

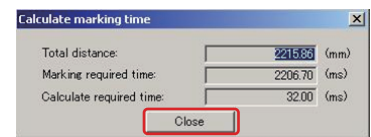

Additional Information

[Marking required time] displayed in the [Calculate marking time] dialog indicates the period of time from the start of laser emission to the end of laser emission. The time spent on the inspection using the DFL is not included in [Calculate marking time].
Use actual marking to confirm the time that is actually required.

5.9 Other Functions

Starting the Font Logo Editor (Offline Editing Software Only)

Starts the Font logo editor from the offline editing software.

- 1 Click [Tool] on the menu bar of the offline editing software, and then select [Font logo editor].

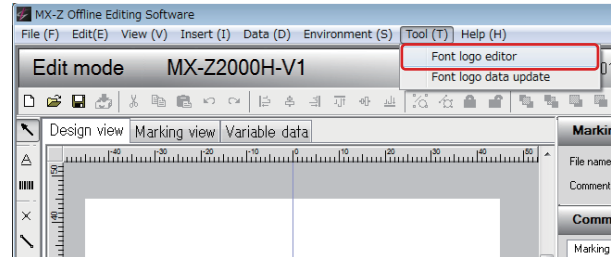

Reference

- "Chapter 11 How to Use Font Logo Editor (page 11-1)"

View Manual (Offline Editing Software Only)

Opens this manual (PDF file) from the offline editing software.

- 2 Click [Help] on the menu bar of the offline editing software, and then select [Manual].

This manual opens.

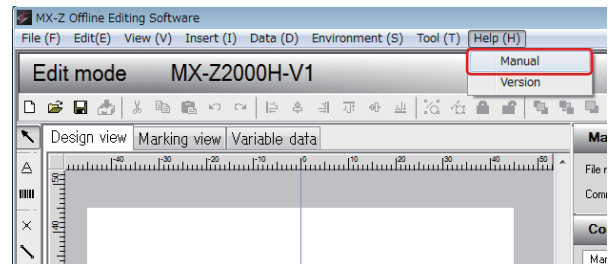

Additional Information

Adobe Reader by Adobe must be installed to open PDF files. Download it from Adobe's website.

Offline Editing Software View Version (Offline Editing Software Only)

Displays the offline editing software version.

- 1 Click [Help] on the menu bar of the offline editing software, and then select [Version].

The offline editing software version is displayed.

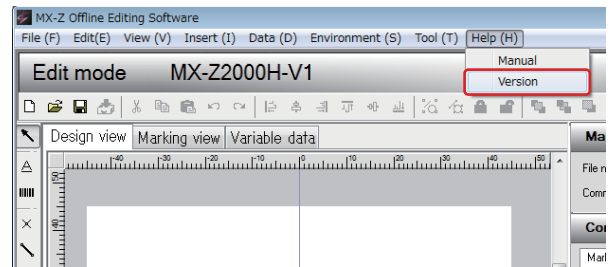

- 2 After checking, click [OK].

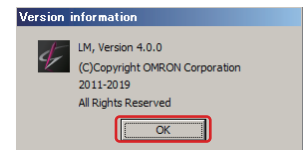

Additional Information

When checking the marker software version, etc., select [Maintenance] - [Version management] on the menu bar, and display the [Version management] dialog box. (Refer to "7.12 Version Management (page 7-19)")

Chapter 6

Environment Setting

Specifies the operating environment settings of this system. When specifying the environment settings, refer to the applicable section based on the following table as the executable functions vary depending on the software type.

Function	Executable software
6.1 Marker Operation Setting 6.2 Edit Setting 6.3 Date/Time Setting 6.4 Operation Limit Setting 6.5 Reset to Default Value 6.6 Language Setting 6.7 Ethernet Setting 6.8 Reference Folder Settings 6.9 Coordinate Correct Setting 6.10 EE Mode Setting	Marker software
6.2 Edit Setting 6.5 Reset to Default Value 6.6 Language Setting 6.8 Reference Folder Settings 6.10 EE Mode Setting	Offline editing software

6.1	Marker Operation Setting	6-2
6.2	Edit Setting	6-8
6.3	Date/Time Setting.....	6-10
6.4	Operation Limits Setting.....	6-11
6.5	Reset to default value	6-14
6.6	Language Setting	6-15
6.7	Ethernet Setting	6-17
6.8	Reference Folder Settings	6-19
6.9	Coordinate Correct Setting.....	6-20
6.10	EE Mode Setting	6-24

6.1 Marker Operation Setting

Specifies the operating settings of the system.

I/O Setting

Sets the interface for I/O communications using external devices.



Reference

For details on I/O communication with external devices, refer to:

- "Fiber Laser Marker MX-Z2000H-V1 series Setup Manual" (415).

Setting procedure

- 1 Click [Environment setting] on the menu bar, and then select [Marker operation]
The [Marker operation setting] dialog box is displayed.
- 2 Select the [I/O setting] tab and set the following items.
Refer to "■ Setting (page 6-3)"
- 3 When the setting has been completed, click [OK].

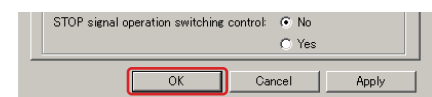
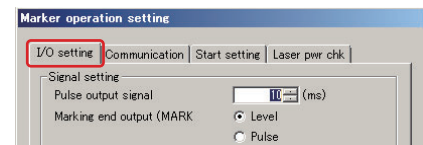
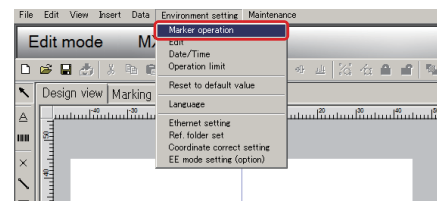

■ Setting

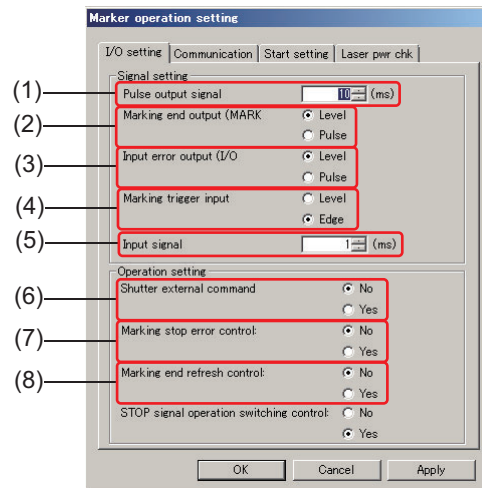

6

● Signal setting

(1) Pulse output signal width

Sets the pulse width when outputting pulse signals.

(2) Marking end output (MARK END)

Sets the method of outputting [MARK END] (marking complete output) signals from the output terminal block of the system.

Sets either [Level] or [Pulse].

(3) Input error output (I/O ERROR)

Sets the method of outputting [IO ERROR] (I/O error output) signals from the I/O connector of the system.

Sets either [Level] or [Pulse].

(4) Marking trigger input (TRIG)

Sets the method of detecting the [TRIG] (marking trigger input) signals from the input terminal block of the system.

Sets either [Level] or [Edge].

(5) Input signal confirmation time

If input is unstable due to chattering in a relay or other connected device, set the minimum duration of time so that the input signal is recognized as input.

Set a time at least twice that required to stabilize input.

● Operation setting

(6) Shutter external command control

Select [No] to execute shutter open/close control when switching between [Edit mode] and [Op mode].

(7) Marking stop error control

[Yes] is selected to put the system in an error status when marking is stopped by a marking stop input.

(8) Marking end refresh control

[Yes] is selected to refresh the galvano-scanner when marking is ended.

The refresh operation is performed for approximately 3 seconds.

This setting is selected when repeatedly marking a very small section.

(9) STOP signal operation switching control

Select [No] when laser/guide laser switching control is performed with the STOP signal before marking is started, select [Yes] when it is performed with the laser signal.



Reference

For details on each signal, refer to:

- "Fiber Laser Marker MX-Z2000H-V1 series Setup Manual" (Z415)

Serial Communication Setting

Sets the communication setting for serial communications using external devices.

Setting procedure

- 1 Click [Environment setting] on the menu bar, and then select [Marker operation].
The [Marker operation setting] dialog box is displayed.
- 2 Select the [Communication] tab and select the following items.
Refer to "■ Setting (page 6-5)"
- 3 When the setting has been completed, click [OK].

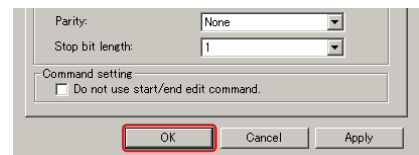
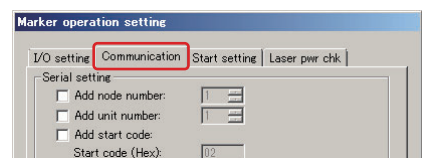
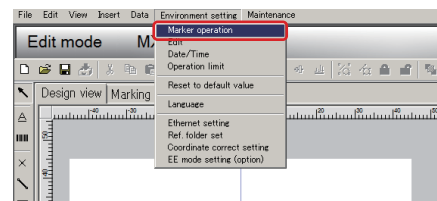

■ Setting

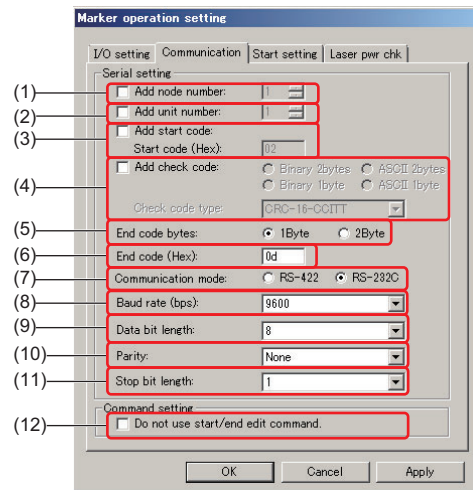

● Serial setting

(1) Add node number

The checkbox is selected when adding the node number of the own unit to a command to set the node number.

(2) Add unit number

The checkbox is selected when adding the unit number of the own unit to a command to set the unit number.

(3) Add start code

The checkbox is selected when adding the start code to the beginning of a command to set the start code (hex).

(4) Add check code

The checkbox is selected when adding a check code (to check for message corruption) to a command to set the code format or check code type.

(5) End code bytes

Sets the size of the end code added at the end of a command.
Either [1Byte] or [2Byte] is selected.

(6) End code (Hex)

Sets the custom end code (00 to 1F).

(7) Communication mode

Sets the communication mode of the serial communication.
Either [RS-422] or [RS-232C] is selected.

(8) Baud rate (bps)

Sets the baud rate.
Either "9600," "19200," "38400," "57600" or "115200" is selected.

(9) Data bit length

Sets the data bit length.

Either "7" or "8" is selected.

(10) Parity

Sets the type of the parity check.

Either "None," "EVEN" (even number) or "ODD" (odd number) is selected.

(11) Stop bit length

Sets the bit length of the stop bit.

Either "1" or "2" is selected.

● Command setting

(12) Do not use start/end edit command

If this checkbox is selected, the start edit command (EDITRESERVEON) or the end edit command (EDITRESERVEOFF) does not need to be executed prior to the execution of the marking data edit command.



Additional Information

When an I/O command is used, the start edit command and end edit command are required. Unselect [Do not use start/end edit command] when using an I/O command.



Reference

- "Chapter 8 Operation and Control by Serial Communication (page 8-1)"
-

Startup Setting



Reference

- "■ Setting at startup (page 1-15)"
-

Laser power check settings

This function checks automatically when the laser power is set and if the laser power falls to the set lower limit threshold, outputs a notice to the user of the error (Type B).



Reference

For details of error codes and their remedial actions, refer to:

- "Fiber Laser Marker MX-Z2000H-V1 series Setup Manual" (Z415)
-

■ Setting procedure

- 1 Click [Environment setting] on the menu bar, and then select [Marker operation]

The [Marker operation setting] dialog box is displayed.

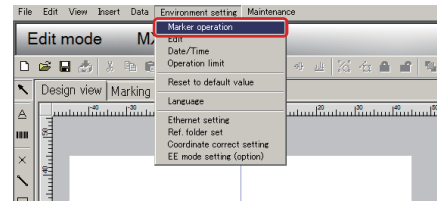

- 2 Select the [Laser pwr chk.] tab, and then set the following items.

- "■ Setting (page 6-7)"

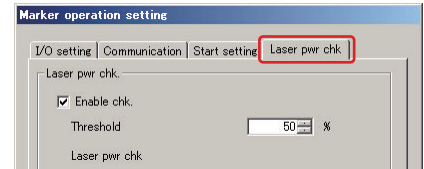

- 3 When the setting has been completed, click [OK].

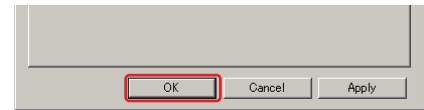

■ Setting

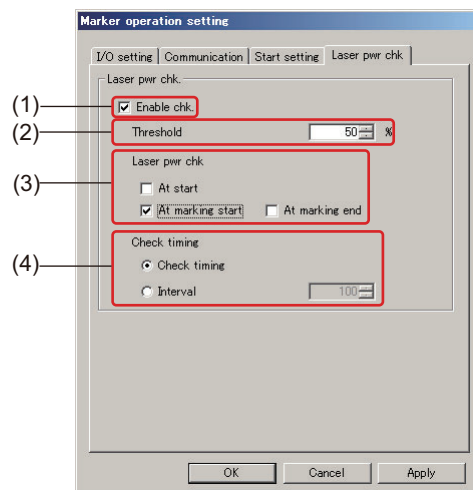

● Laser pwr chk.

(1) Enable chk.

This checkbox is selected to enable checking.

(2) Threshold

Sets the laser power lower limit threshold beyond which the power is considered abnormal.

(3) Laser pwr chk

Sets the timing for checking the laser power.

Select At start, At marking start, or At marking end.

(4) Check timing

Sets the timing at marking start, or at marking end.

- Check timing: Check the laser power at each marking.
- Interval: Check the laser power for each marking with the set marking count. The marking count is retained even when the power is turned OFF, and the next marking will continue counting.

6.2 Edit Setting

Sets the various functions to edit marking data.

■ Setting procedure

- 1 Click [Environment setting] on the menu bar, and then select [Edit].

The [Edit setting] dialog box is displayed.

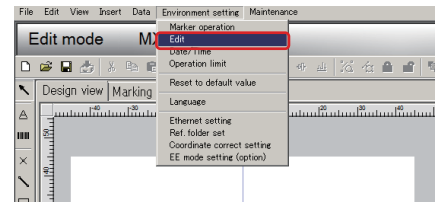

- 2 Set the following items.

Refer to "■ Setting (page 6-9)"

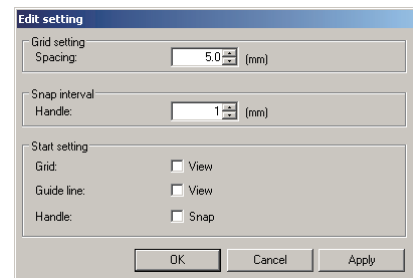

- 3 When the setting has been completed, click [OK].

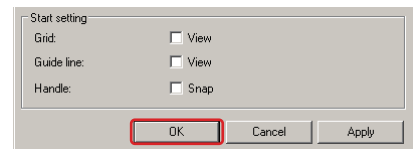

■ Setting

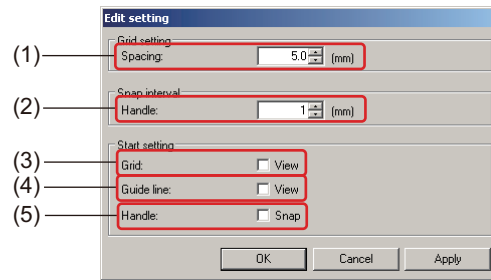

6

● Grid setting

(1) Spacing

Sets the grid interval (unit: mm).

● Snap interval setting

(2) Handle

When there are multiple blocks, the maximum interval (unit: mm) to snap a block to the handle of the closest block is set.

The block snaps when the interval between the blocks is smaller than the value set here.

● Start setting

(3) Grid

This checkbox is selected to display grid when starting the marker software.

(4) Guide line

This checkbox is selected to display guide line when starting the marker software.

(5) Handle

This checkbox is selected to snap the handle when starting the marker software.

6.3 Date/Time Setting

Sets the date/time of the system.

■ Setting procedure

- 1 Click [Environment setting] on the menu bar, and then select [Date/Time]
The [Date/Time setting] dialog box is displayed.

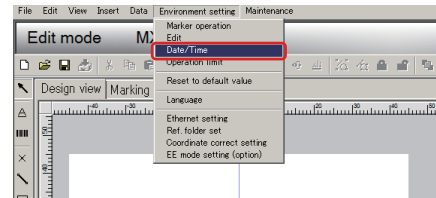

- 2 Set the date and time and click [OK].

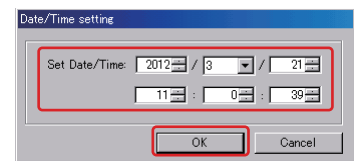

The set date and time are displayed.

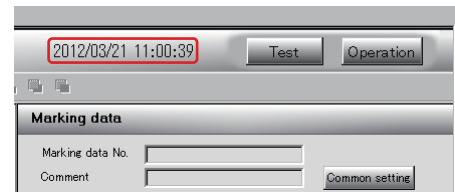

6.4 Operation Limits Setting

Sets the operation limit when restricting the operation of the marker software by an unauthorized person, etc.

■ Setting procedure

- 1 Click [Environment setting] on the menu bar, and then select [Operation limit].

The [Operation limit setting] dialog box is displayed.

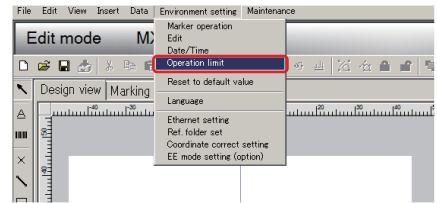

- 2 Click [View function mask].

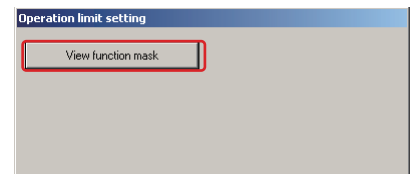

- 3 When the [Enter password] dialog box is displayed, enter the password currently set in [Current password], and click [OK].

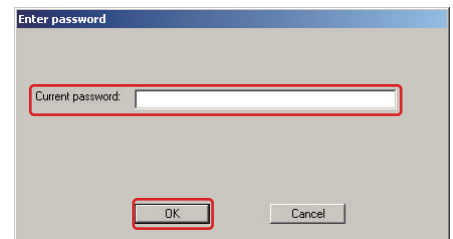

Additional Information

- The default password is "None." (No password needs to be entered in [Current password].) As necessary, set the password. (Refer to "● Setting/changing the password (page 6-13)".)
- If you forget the password, contact OMRON.

- 4 Set the following items in the [Operation limit setting] dialog box.

Refer to "■ Setting (page 6-12)"

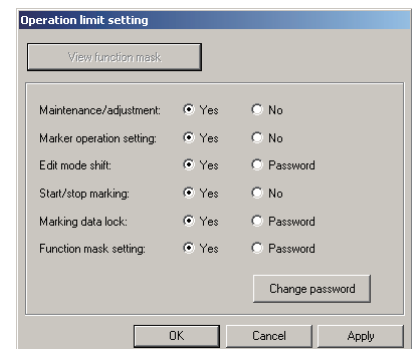

- 5 When the setting has been completed, click [OK].

■ Setting

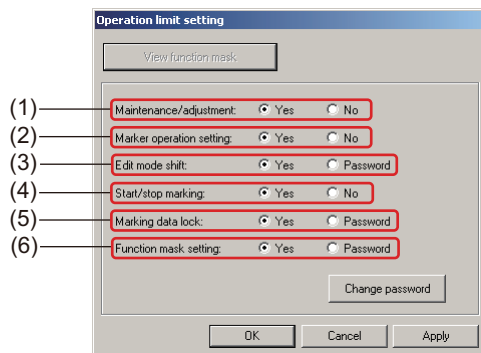

● Operation limit setting

(1) Maintenance/adjustment

Sets whether to allow or prohibit the settings in [Maintenance] on the menu bar.
Either [Yes] or [No] is checked.

(2) Marker operation setting

Sets whether to allow or prohibit the settings in [Environment setting] - [Marker operation] on the menu bar.
Either [Yes] or [No] is checked.

(3) Edit mode shift

Sets whether to always allow the transition from the operation mode to the edit mode, or to allow only with a password input.
Either [Yes] or [Password] is checked.

(4) Start/stop marking

Sets whether to allow or prohibit the marking [Start]/[Stop] operations on the [Operation mode] screen.
Either [Yes] or [No] is checked.

(5) Marking data lock

Sets whether to allow locking/unlocking of marking data on the [Operation mode] screen or to allow only with a password input.
Either [Yes] or [Password] is checked.

(6) Function mask setting

Sets whether to always allow this dialog box to be displayed or to allow only with a password input.
Either [Yes] or [Password] is checked.

- **Setting/changing the password**

- 1 Click [Change password] in the [Operation limit setting] dialog box.**

The [Change password] dialog box is displayed.

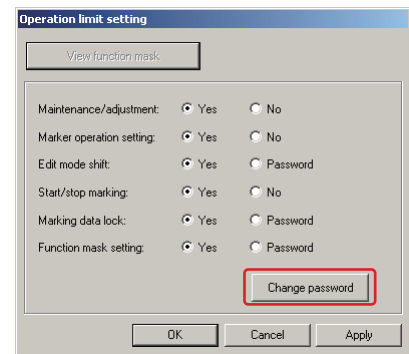

- 2 Enter the current password in [Current password] and the new password to be set in [New password] and [Confirm password], and click [OK].**

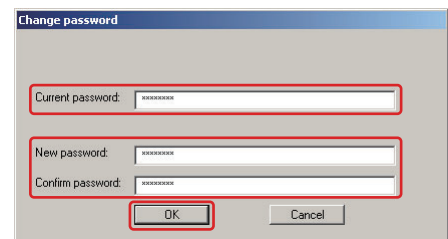

Additional Information

- The default password is "None." (No password needs to be entered in [Current password].)
- If you forget the password, contact OMRON.

6.5 Reset to default value

Restores the factory setting default value of [Common setting] or each block property.

■ Setting procedure

- 1 Click [Environment setting] on the menu bar, and then select [Reset to default value].
The [Reset to default value] dialog box is displayed.

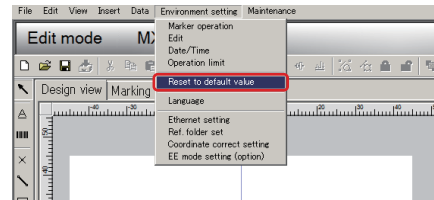

- 2 Select the items to be initialized, and click [OK].

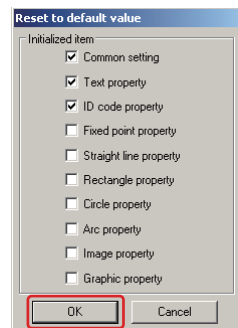

6.6 Language Setting

Set the display language (Japanese/English/Chinese (simplified)) of the marker software, the offline editing software and the Font logo editor, as well as the input environment of the marker software.

■ Setting procedure

- 1 Click [Environment setting] on the menu bar, and then select [Language].

The [Language] dialog box is displayed.

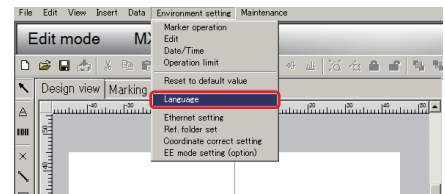

Additional Information

- The subsequent display screens are different between the marker software and the offline editing software/font logo editor.
- Settings must be made individually for the marker software, online editing software, and font logo editor.

- 2 Select the display language.

For the marker software, select the input environment.

<Marker software>

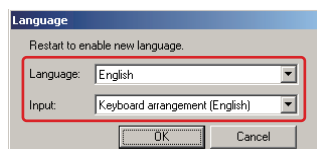

<Offline editing software/
Font logo editor>

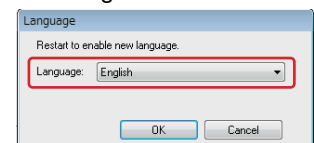

- 3 Click [OK].

A restart is required to finish the update.

<Marker software>

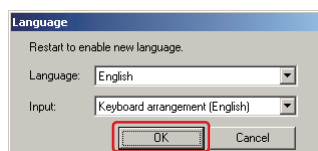

<Offline editing software/
Font logo editor>

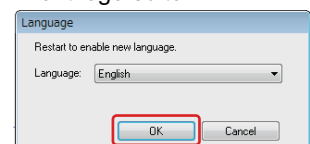

Restart confirmation message is displayed.

<For marker software>

Click [OK] to automatically restart.

<For offline editing software/font logo editor>

Click [OK] to close the message.

Manually restart the software.

<Marker software>

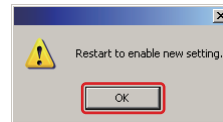

<Offline editing software/
Font logo editor>

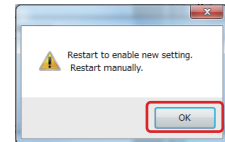

6.7 Ethernet Setting

Set the network for using the Ethernet communication.



Additional Information

If using Ethernet communication or EtherNet/IP communication, configure the network settings.

6

Setting procedure

- 1 Click [Environment setting] on the menu bar, and then select [Ethernet setting].

The [Ethernet setting] dialog box is displayed.

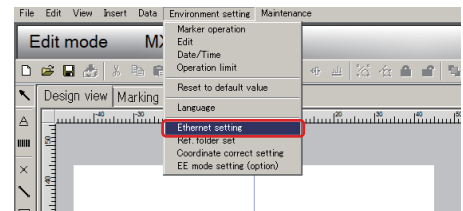

- 2 Set the each items in the [Ethernet setting] dialog box.

Refer to "■ Setting (page 6-18)"

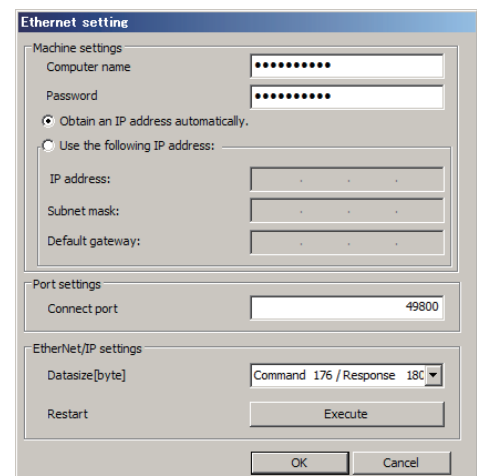

- 3 When the setting has been completed, click [OK].

■ Setting

The screenshot shows the 'Ethernet setting' dialog box. It is divided into several sections:

- Machine settings:** Contains 'Computer name' (1) and 'Password' (2) text boxes.
- IP Address Selection:** Contains radio buttons for 'Obtain an IP address automatically.' (3) and 'Use the following IP address:'. Below this are text boxes for 'IP address:', 'Subnet mask:', and 'Default gateway:'.
- Port settings:** Contains a 'Connect port' text box (4) with the value '49800'.
- EtherNet/IP settings:** Contains a 'Data size [byte]' dropdown menu (5) with 'Command 176 / Response 18C' selected.
- Restart:** Contains a 'Restart' button (6) with an 'Execute' label.

At the bottom of the dialog are 'OK' and 'Cancel' buttons.

● Machine settings

- (1) Computer name
Sets the computer name.
- (2) Password
When necessary, sets the password.
- (3) Obtain an IP address automatically. / Use the following IP address.
Selects whether to obtain an IP address automatically or to use the set IP address.
If you selected [Use the following IP address.], set [IP address], [Subnet mask], and [Default gateway].
- (4) Connect port
Specifies the port numbers for connecting external devices, such as PC or PLC, to this system.
Default: 49800

● EtherNet/IP settings

- (5) Data size
Select the data size when making a data link over EtherNet/IP.
Press the OK button to apply the selected data size.



Additional Information

- The default setting of MX-Z2000H-V1 Series is 176/180 bytes. However, this can be set to 92/96 bytes to ensure compatibility with MX-Z2000H Series.
- If this parameter is set to 92/96 bytes, change the sizes listed for the PLC tag/set setting and connection setting to 92 bytes and 96 bytes (listed in "10.2 Communications Setup Procedures (page 10-6)").
For details, refer to "Fiber Laser Marker MX-Z2000H series Setup Manual" (Z376).

- (6) Restart
If MX-Z2000H-V1 Series is connected over EtherNet/IP to a PLC or other controller, this will disconnect the current connection and then reconnect it.



Additional Information

For items (1) through (5), press the OK button to apply the setting.
For item (6), press the Run button to perform an immediate restart.

6.8 Reference Folder Settings

Specify the folder referencing the set data.

If the specified folder does not exist, the laser marker internal settings are referenced.

■ Setting procedure

- 1 Click [Environment setting] on the menu bar, and then select [Ref. folder set].

The [Ref. folder set] dialog box is displayed.

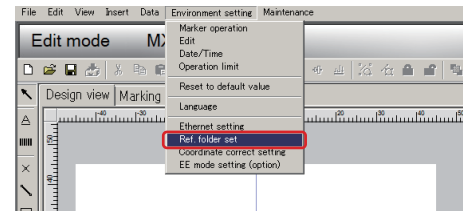

- 2 Click [...].

The [Ref. folder set] dialog box is displayed.

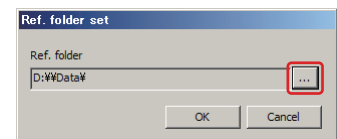

- 3 Specify the folder containing the data to reference, and then click [OK].

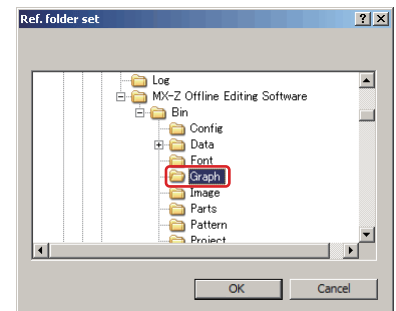

Now, the folder referencing the set data is specified.

As necessary, from the [Edit mode] screen or [Operation mode] screen, select to load the marking data, and perform marking.



Additional Information

When a folder on the network is specified in the reference folder setting, and if an Ethernet communication error occurs, the setting to reference a folder on the laser marker unit will apply.

6.9 Coordinate Correct Setting

By setting a correction value for the actual coordinate grid marked on the work, this corrects to approximate the ideal coordinate grid in the marking data and improve the absolute position precision for the marking. The coordinate correction value is registered here.

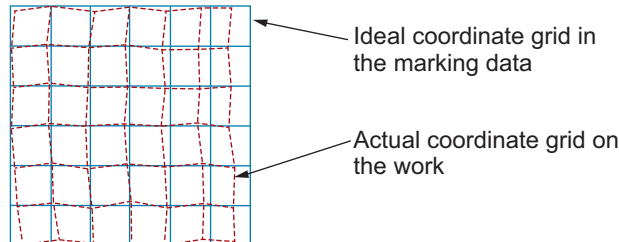

In order to correct the coordinates, it is necessary to pre-register the correction values with the coordinate correct setting and to enable the correction values with [Coord correct] in common setting.



Reference

For details on how to enable the correction values, refer to:

- "2.7 Common Setting (page 2-108)"

Setting procedure

- 1 Click [Environment setting] on the menu bar, and then select [Coordinate correct setting]. The [Coordinate correct setting] dialog box is displayed.

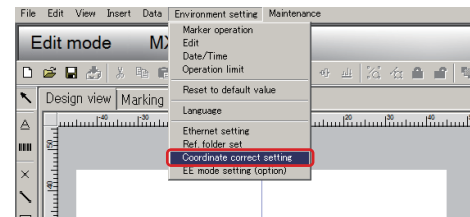

- 2 Select the number of coordinate points to correct with [Correct].



- 3 Select the row of coordinates to correct with [Input pos].

The selection in Step 2 changes the grid display on the right side of the screen. The input position row selected in Step 3 is displayed in red on the grid display.

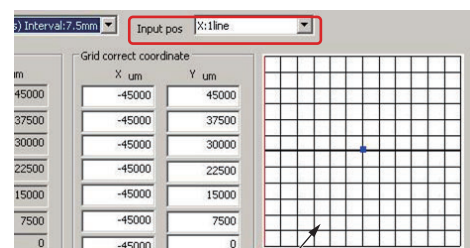

Grid view

- 4 Sets the value of the correction coordinates in [Grid correct coordinate].

Grid correct coordinate	
X um	Y um
-45000	45000
-45000	37500
-45000	30000
-45000	22500
-45000	15000
-45000	7500
-45000	0
-45000	-7500
-45000	-15000
-45000	-22500
-45000	-30000
-45000	-37500
-45000	-45000

- 5 Repeat Steps 3 and 4 and set the required coordinate correction values.

- 6 When the setting has been completed, click [OK].

U	X um	Y um
000	-45000	-7500
000	-45000	-15000
000	-45000	-22500
000	-45000	-30000
000	-45000	-37500
000	-45000	-45000

Marking adjustment:

Grid correct enable

Power: (%)

Laser mode:

Coordinates correction data initialization:



Additional Information

To set the coordinate correct settings, measure and register the correction values with the following procedure.

- 1 Prepare a work to be measured on which markings can be applied (Marking area: 90 x 90 mm for MX-Z2000H-V1, 160 x 160 mm for MX-Z2050H-V1/Z2055H-V1).
- 2 With the conditions set with [Marking adjustment], mark the grid lines in the marking area on the work to be measured.
- 3 Measure each point on the grid lines marked on the work to be measured with a microscope, then register the actual measured value as a correction value for a target point.

■ Setting

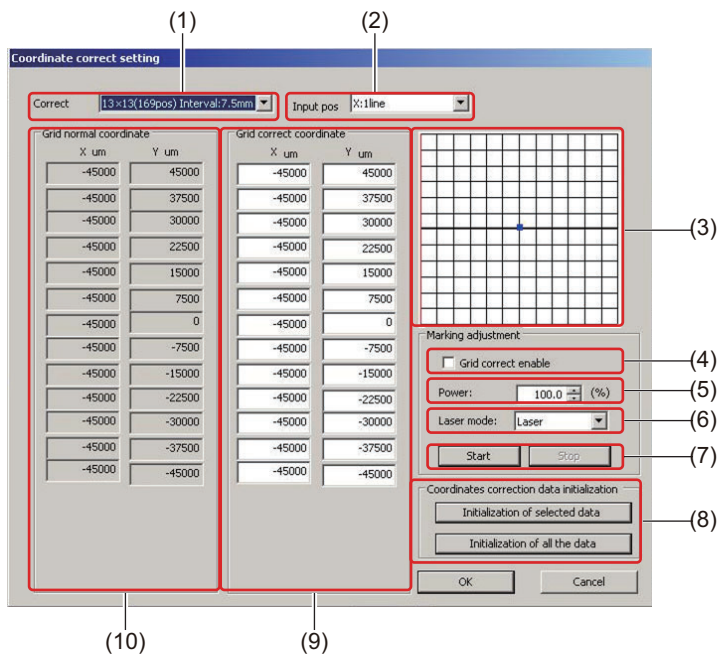

(1) Correct

Selects the number of coordinate points to correct.

(2) Input pos

Selects the row for setting the correction value.

(3) Grid view

Switches the grid view according to the contents selected with [Correct type]. Also, the row selected with [Input pos] is highlighted in red.

(4) Grid correct enable

When the grid is marked, this enables the correction values entered in [Grid correct coordinate].

(5) Power

Sets the laser power for marking the grid.

(6) Laser mode

Selects the laser mode for marking the grid.

Item	Description
Laser	Marking is executed with actual laser.
Guide laser	Marking content is scanned with guide laser.

(7) [Start]/[Stop]

Starts/stops grid marking.

(8) Coordinates correction data initialization

Initializes the correction values for the row selected with [Input pos] in [Initialization of selected data].

Initializes all the correction values with [Initialization of all the data].

(9) Grid correct coordinate

Enters the X-direction and Y-direction coordinate correction values for each column selected with [Input pos].

(10) Grid normal coordinate

The ideal grid coordinates are displayed.

6.10 EE Mode Setting

A deeper marking than the standard mode is possible by using EE mode. It is effective in solving problems such as the marking becoming less visible due to post processes after marking or when you want the marking to stand out more.



Additional Information

This mode is optional. Purchasing a license is required to enable this mode.

Setting procedure

- 1 Click [Env set.] on the menu bar, and then select [EE mode setting].

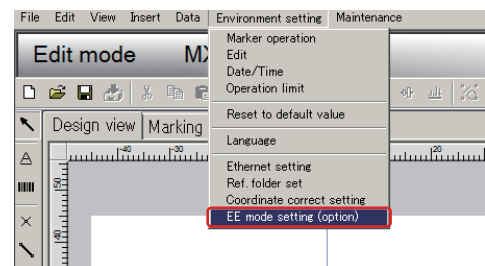

The [EE mode setting] dialog box is displayed.

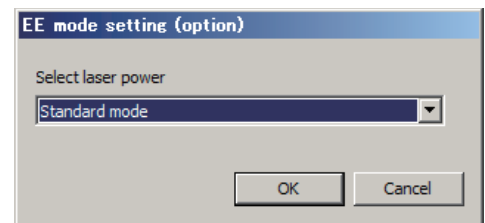

Additional Information

When you select the EE mode setting for the first time, [Activation] dialog box is displayed.

Enter the "activation key" on the license certificate, then press the [OK] button.

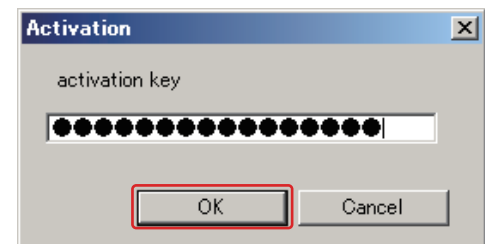

If activation is performed with an invalid "activation key", the error dialog box is output.

Once activation is complete, this dialog box is no longer displayed.

This dialog box is not displayed with offline software.

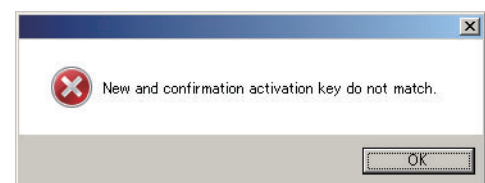

- 2 Press the [OK] button on the [EE mode setting] dialog box.**

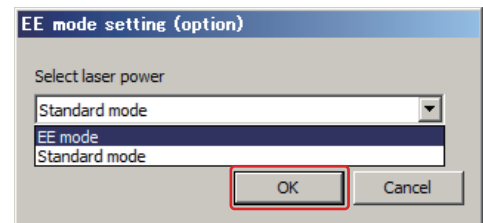

- 3 Press the [OK] button on the dialog box requesting to restart.**
When shutdown is complete, turn the breaker ON again.

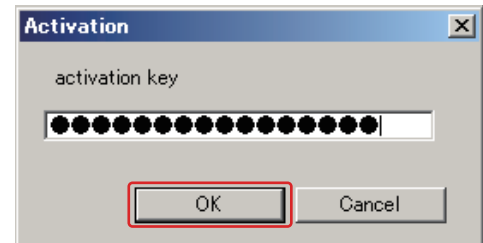

Additional Information

When the marker is already in the EE mode, shutdown is not performed and the dialog box requesting to restart is not displayed.

- 4 After the marker is restarted, operations can be performed in the EE mode.**

When the marker is in the EE mode, "EE mode" is displayed next to the model name on the edit mode screen.

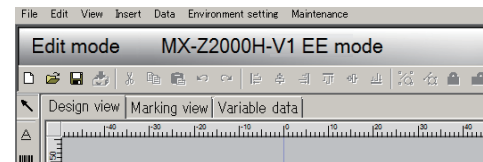
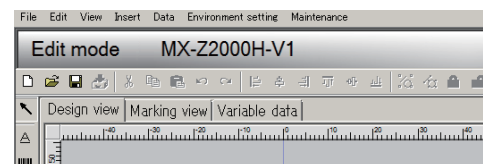

Additional Information

Switching from the EE mode to the standard mode can be performed in the same procedure.

■ EE mode/standard mode setting of the marking data

When marking data created in the standard mode or EE mode is called in a different mode, the following message is displayed.

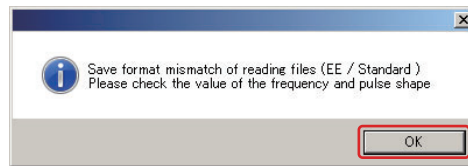

⚠ Precautions for Safe Use

When marking data is called in the mode different from the startup mode, the frequency and pulse shape are automatically changed to the specified values under the following conditions.

- When marking data stored with the frequency greater than 100.0 kHz set in the standard mode is called in the EE mode, the frequency is automatically set to 100.0 kHz.
 - When marking data stored with the pulse shape between 4 to 15 set in the standard mode is called in the EE mode, the pulse shape is automatically set to 1.
-

Chapter 7

Maintenance and Adjustment

Maintains and adjusts the system.
Only the marker software can be executed.

7.1	Position Correction	7-2
7.2	Power Monitor	7-4
7.3	Warm Up	7-7
7.4	History/Trace Output	7-8
7.5	Traceability Log Setting	7-9
7.6	Life Counter	7-11
7.7	Get Z-axis Home	7-12
7.8	I/O Test	7-13
7.9	Serial Communication Test	7-14
7.10	Backup/Restore	7-15
7.11	Installing TrueType Fonts	7-17
7.12	Version Management	7-19

7.1 Position Correction

Set the focus distance and the marking position.



Reference

For information on how to correct positions, refer to:

- "Fiber Laser Marker MX-Z2000H-V1 series Setup Manual" (Z415)

Setting procedure

- 1 Click **[Maintenance]** on the menu bar, and then select **[Position correction]**.

The **[Position correction]** dialog box is displayed.

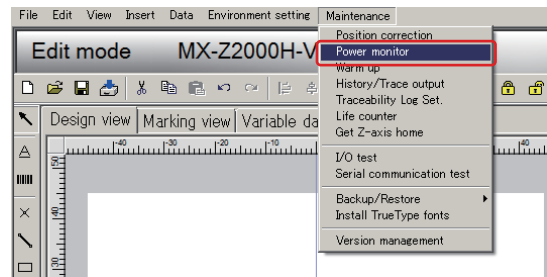

- 2 Set each item and click **[Setting]**.

Refer to "■ Setting (page 7-3)"

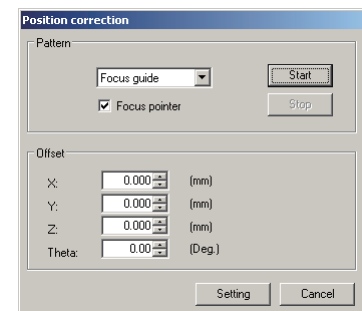

■ Setting

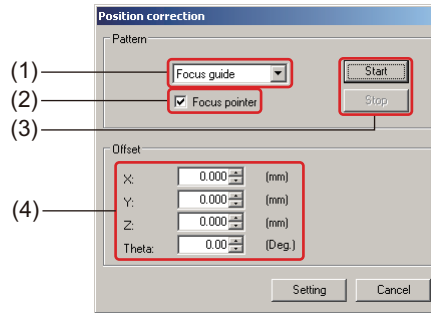

7

● Pattern

(1) Pattern

The pattern of guide laser is selected.

Pattern	Description
Focus guide	Used to adjust the focus distance. Emits guide laser of the pattern "#."
Center point	Used to verify the X-axis/Y-axis origins. Emits guide laser to the center point specified with [X]/[Y] in the offset setting.
Cross line	Used to verify the X-axis/Y-axis origins. Emits "+" pattern guide laser to the center point specified with [X]/[Y] in the offset setting.

(2) Focus pointer

This checkbox is selected to emit a focus pointer.

(3) [Start]/[Stop]

Emits/stops guide laser and focus pointer.

● Offset

(4) X/Y/Z/Theta

A correction value (offset value) for X-axis, Y-axis, Z-axis, and rotation angle Theta (θ) are entered.



Additional Information

When emitting "Focus guide" as guide laser, the emission position does not move even if the correction value for X-axis/Y-axis/rotation angle Theta (θ) is changed. Note, however, that it will move if the position is "Cross line" or "Center point."



Reference

For details on X-axis, Y-axis, Z-axis, and rotation angle Theta (θ), and the offset setting, refer to:

- "2.2 Coordinate (page 2-3)"
- "Fiber Laser Marker MX-Z2000H-V1 Setup Manual" (Z415)

7.2 Power Monitor

The laser power can be measured for inspection when the system is installed or for periodic inspections after operations have begun. On this system, the laser power can be measured without any external devices or by emitting at a fixed point on a processing surface using a power meter.

- 1 Click **[Maintenance]** on the menu bar, and then select **[Power monitor]**.

The **[Power monitor]** dialog box is displayed.

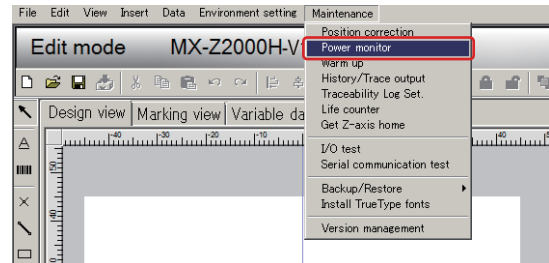

- 2 Select the measuring method.

- When checking the laser power using the built-in power monitor function: Proceed to step 3.
- When checking the laser power on a processing surface: Set the laser output value in **[Power]**.

The value can be set at 10% intervals between 10 and 100%.

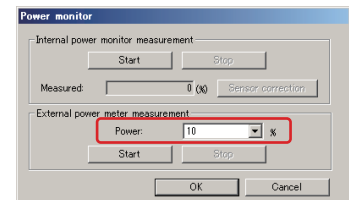

Additional Information

When measuring the laser power on a processing surface, make preparations, in advance, to measure the laser power on a processing surface using an external device, such as a power meter.

- 3 Click **[Start]** according to the measuring method.

When measuring the laser power using the built-in power monitor

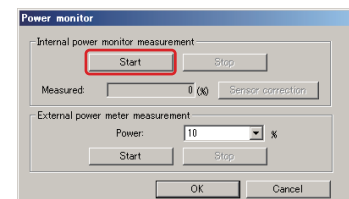

When measuring the laser power on a processing surface

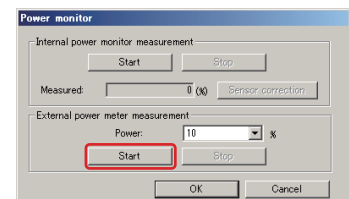

- 4 Click [Yes].**
The measurement of the laser power will start.

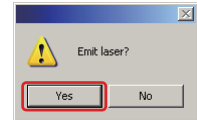

Precautions for Correct Use

A laser is irradiated for measurement. Exercise caution when measuring the laser power on a processing surface.

After a while, the laser power in % will be displayed in [Measured].

In the factory default setting or when the sensor has been corrected, the laser power at that time will be displayed at 100%.

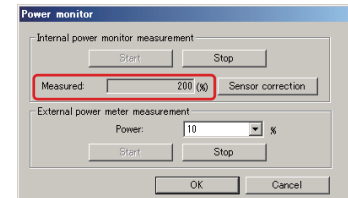

Additional Information

The measurement will start immediately after the [Yes] button is clicked. Wait for 3 minutes or so, and then check the measurement value.

- 5 To end the measurement, click [Stop].**
The laser emission will be stopped, and the measurement will end.

When the laser power was measured using the built-in power monitor

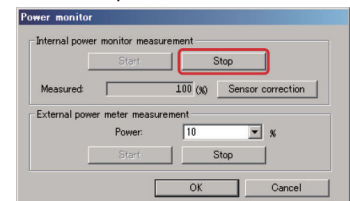

When the laser power was measured on a processing surface

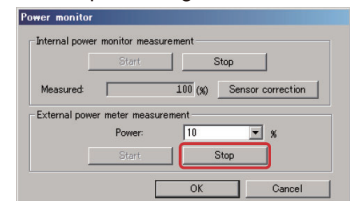

■ Executing sensor correction

When the wiring path of the fiber cable is changed, the quantity of light received by the sensor may change and there may be an error in the measurement value due to the change in the polarization condition. In such a case, perform sensor correction.



Additional Information

To perform sensor correction, wait for about 3 minutes after starting measurement, and then press the sensor correction button.

1 Click [Sensor correction] while the laser power is being measured.

The [Sensor correction] dialog box is displayed.

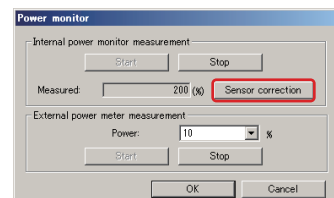

2 Click [OK].

The current laser power value will be set to 100%.

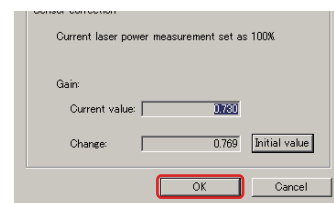

Additional Information

- Click [Initial value] to restore the sensor correction value to the factory default setting. If a correction is made by mistake, the factory default setting can be restored.
- Sensor correction is not to be used for the purpose of correcting the laser power.

7.3 Warm Up

Warm up the system manually at any given time.

In this case, the system will be warmed up based on the conditions set in [Warm up setting] under "Start setting". (Refer to "■ Setting at startup (page 1-15)").

If the conditions are not set in [Warm up setting], the warm-up will be performed based on the preset system conditions.

Use the warm-up function for the following purposes.

- Perform a galvano operation for a certain amount of time when the laser marker is started in order to stabilize the system operation.
- The consumption of the scanning motor can be minimized by periodically executing the function when marking microscopic sized letters or repeatedly marking between very small sections.
- When the ambient temperature fluctuates significantly, the laser power can be temperature-corrected by executing this function periodically.

The system can be warmed up externally using communication commands.

- 1 Click [Maintenance] on the menu bar, and then select [Warm up].

The [Warm up] dialog box is displayed.

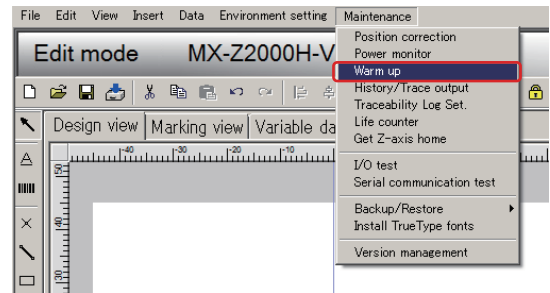

- 2 Click [Start].

Warm-up will start.

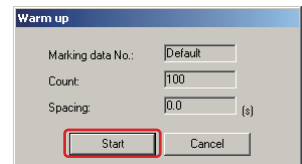

Additional Information

Marking is not allowed during warm-up.

7.4 History/Trace Output

The operation and error histories can be obtained in text format and saved to the USB memory.

- 1 Insert the USB memory to which the output data is to be saved into the system's [MEMORY] connector.
- 2 Click [Maintenance] on the menu bar, and then select [History/Trace output].
The [History/Trace output] dialog box is displayed.

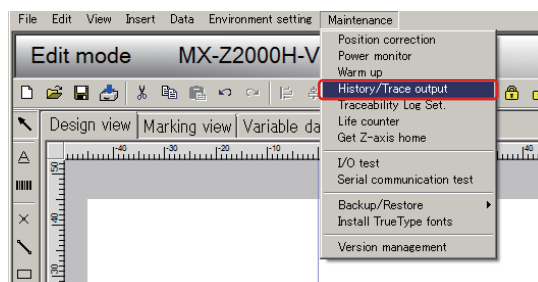

- 3 Select the checkbox for the type of data to be obtained, and click [Get].

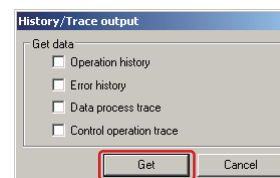

The data that can be obtained are as follows.

Item	Description
Operation history	Obtains the operation history.
Error history	Obtains the error history.
Data process trace	Obtains the various operation traces.
Control operation trace	This is for system maintenance.

7.5 Traceability Log Setting

Outputs marking data, counter information, and other data to the specified log output destination.

- 1 Click **[Maintenance]** on the menu bar, and then select **[Traceability Log Set.]**. The **[Traceability Log Set.]** dialog box is displayed.

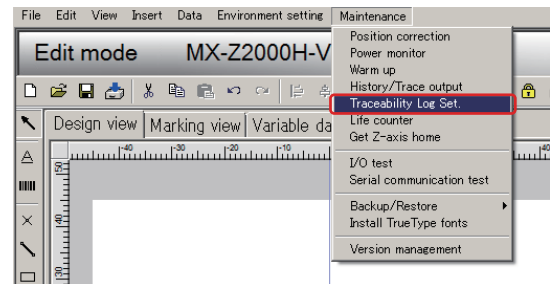

- 2 Click **[...]**, then select the log output destination.

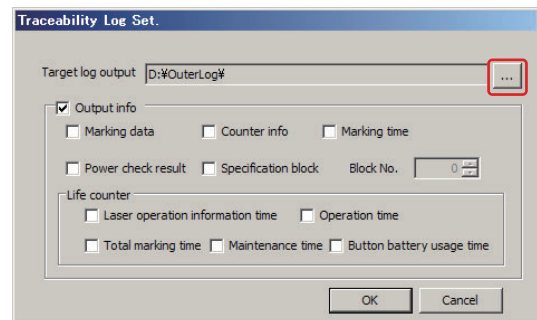

- 3 Select the checkbox for data to be output with **[Output Info]**, then click **[OK]**.

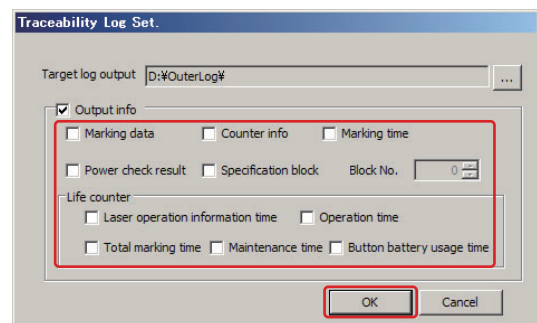

The data that can be obtained are as follows.

Item	Description
Power ON ^{*1}	Acquires the power on status of the laser marker.
Marking data	Acquires the marking data name for which marking was performed.
Counter info	Acquires the current value of the counter.
Marking time	Acquires the most recent marking time.
Power check result	Acquires the results of the most recent power check.
Specification block	Acquires the marking contents for the specified block.
Accumulated laser operation time ^{*2}	Acquires the accumulated laser operation time.
Operation time ^{*2}	Acquires the operation time information.
Total marking time ^{*2}	Acquires the total marking time.
Maintenance time ^{*2}	Acquires the maintenance time
Button battery usage time ^{*2}	Acquires the button battery usage time.

^{*1} This item was added in software Ver4.1.1.

^{*2} Acquired value is the current value of life counter.



Additional Information

There is no **[Power ON]** selection field in **[Output Info]**. The **[Power ON]** status is always acquired, and the log is output to the output destination selected in **[Target log output]**.

■ Output Contents of Traceability Log

The traceability log is output in the following format.

Log output date, Log output time, Internal information (MX..... ,OnMarkingNotice), output content

The following contents are output according to the output timing and items specified.

Output timing	Item	Output content
At power on	Power ON	Power on ^{*1}
At execute power check.	Power check result	Laserpowercheck[Power check result]
At marking start	Marking data	MarkingInfo[Marking start, Marking data name, Marking data No., comment]
	Specification block	BlockInfo[Block No.: Block information string]
At marking end	Marking data	MarkingInfo[Mark end or Marking stop, Marking data name, Marking data No., comment]
	Marking data	MarkingTime[Mark end or Marking stop, Marking total time(s), Marking time(s)]
	Counter Info	CounterInfo[Current Continuous count, ?Cell:Cell No., Enable counter No.: current value]
	Specification block	BlockInfo[Block No.: Block information string]
	Accumulated laser operation time	LifeCounter[Accumulated laser?operation time (h)]
	Operation time	LifeCounter[Operation time (h)]
	Total marking time	LifeCounter[Total marking time (h)]
	Maintenance time	LifeCounter[Maintenance time (h)]
	Button battery usage time	LifeCounter[Button battery usage time (h)]

*1 This item was added in software Ver4.1.1.

7.6 Life Counter

Indicates the system operation time. An alarm will be generated if the alarm level time is exceeded.

- 1 Click **[Maintenance]** on the menu bar, and then select **[Life counter]**.

The **[Life counter]** dialog box is displayed.

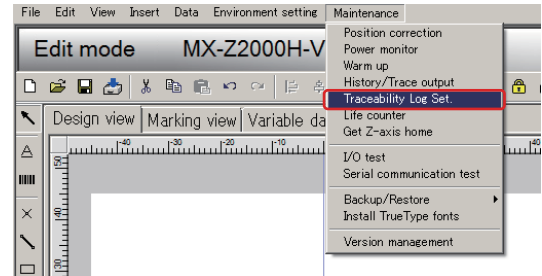

- 2 To change the current value and the alarm level, select the item to be changed, and click **[Change]**.

The **[Change life counter]** dialog box is displayed.

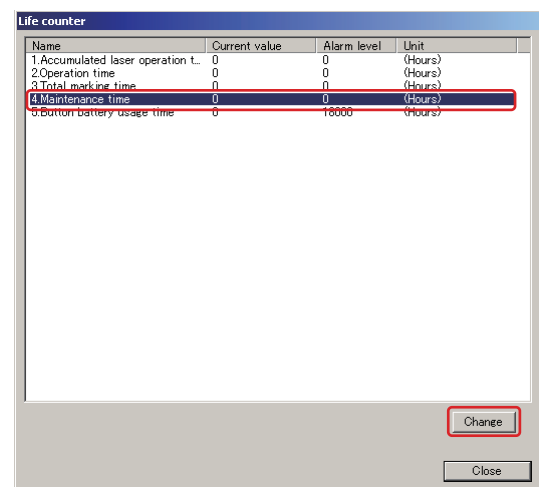

- 3 Set the current value to be set in **[Current value]**, and the operation time at which an alarm is to be generated in **[Alarm level]**, and click **[OK]**.

The value of the **[Life counter]** dialog box is updated.

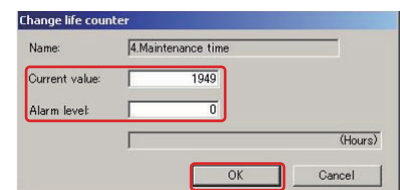

Additional Information

- The "Accumulated laser operation time" is counted as part of the laser shining time.
- The "Operation time" is counted as part of the controller operation time.
- The "Total marking time" is counted as part of the total laser shining and guide laser shining time.
- The "Maintenance time" is counted as part of the controller operation time. The alarm level can be set by the user based on the purpose.
- The back-up time, which is when the system power supply is turned OFF, is counted for the "Button cell use time."
- When the button battery is replaced, set the [Current value] of "Button battery usage time" to "0."
- No alarm will be generated if the [Alarm level] is set to "0."

7.7 Get Z-axis Home

Return the Z axis setting to the factory default.

- 1 Click **[Maintenance]** on the menu bar, and then select **[Get Z-axis home]**.

A message confirming to get home is displayed.

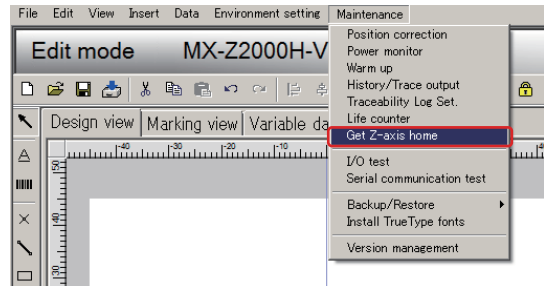

- 2 Click **[Yes]**.

The Z-axis home will be obtained.

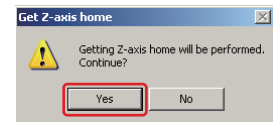

7.8 I/O Test

The button, the I/O terminal block and the I/O connector ON/OFF operations can be manually performed.

- 1 Click [Maintenance] on the menu bar, and then select [I/O test].

The [I/O test] dialog box is displayed.

The I/O status can be checked in this dialog box.

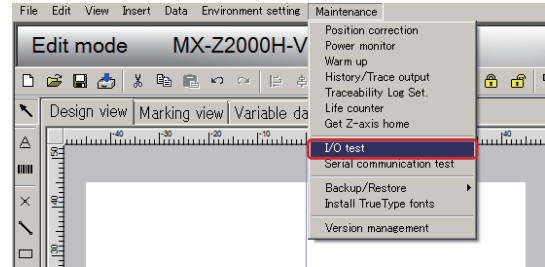

- 2 Select the output for the ON/OFF operation.

The ON/OFF is toggled every time the item is clicked.

The I/O for pulse output is displayed as "PULSE" and, when clicked, it is temporarily set to ON.

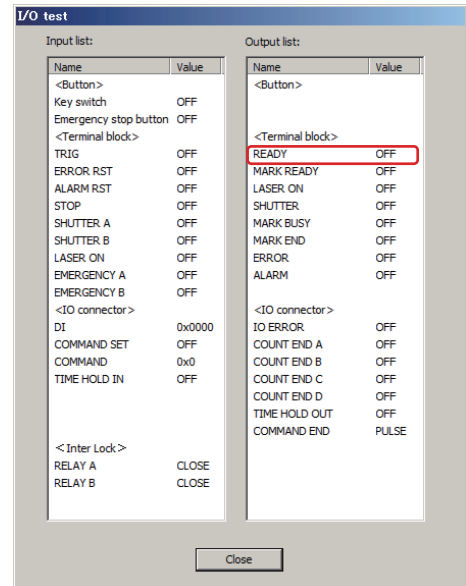

- 3 To end, click [Close].

7.9 Serial Communication Test

When controlling serial communication with an external device, you can check the communication by sending the manually entered data from the system or displaying the received data.

- 1 Click **[Maintenance]** on the menu bar, and then select **[Serial communication test]**. The **[Communication test]** dialog box is displayed.

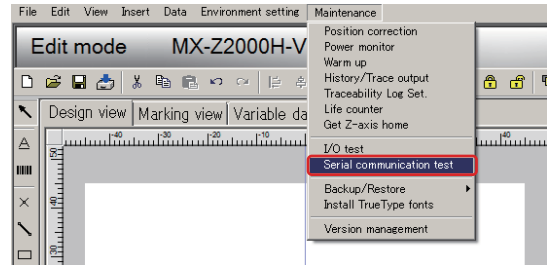

- 2 Enter the command to be sent in **[Text input]** in **[Send data]**, and click **[Decode]** to convert the data into hex data, and then click **[Send]**.

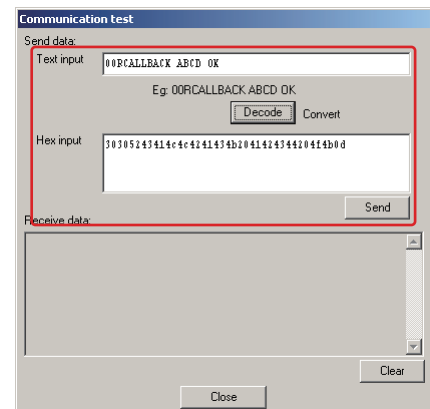

Additional Information

- Information set in **[Environment setting]** on the menu bar - **[Marker operation]** - **[Communication]** tab - **[Serial setting]** is added to the converted data. (Refer to "● Serial setting (page 6-5)")
- Data can also be directly entered in **[Hex input]** under **[Sent data]**.

The received data corresponding to the data sent is displayed in **[Receive data]**.

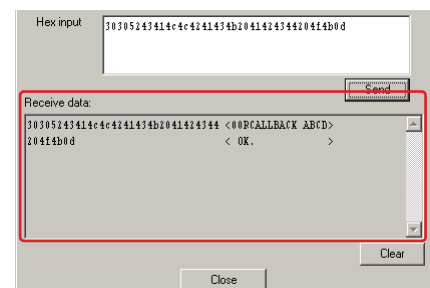

Additional Information

Click **[Clear]** to clear the displayed data received.

- 3 To end, click **[Close]**.

7.10 Backup/Restore

All marking data and the system settings on the device can be backed up and restored. This function is used for individual devices to back themselves up. Do not restore the backup data onto a different device.

Precautions for Correct Use

Never turn OFF the system power supply while marking data is being backed up or restored. The data may be damaged.

7

Backing Up the Marking Data

Back up the marking data on the system to the USB memory.

- 1 **Connect the USB memory to which the marking data is to be saved to the [MEMORY] connector on the system.**
- 2 **Click [Maintenance] on the menu bar, and then select [Backup/Restore] and [Backup].**
The [Backup] dialog box is displayed.

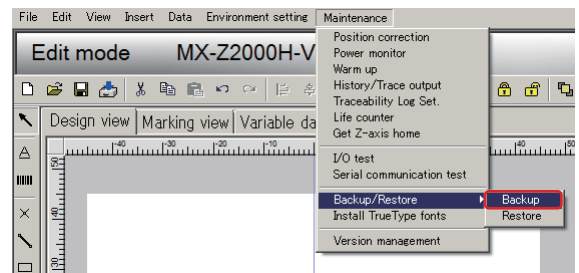

- 3 **Click [...], then select the backup output destination.**

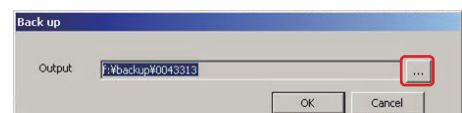

- 4 **Click [OK].**
The marking data backup process will start.

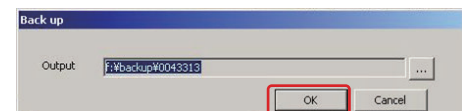

Restoring the Marking Data

Restore the marking data backed up on USB memory on the system.

- 1 Connect the USB memory containing the marking data to the [MEMORY] connector on the system.
- 2 Click [Maintenance] on the menu bar, and then select [Backup/Restore] and [Restore].
The [Restore] dialog box is displayed.

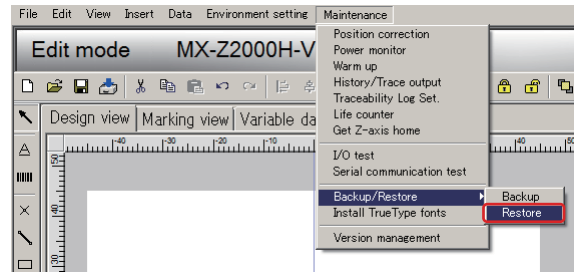

- 3 Click [...], then select the restore reference source.

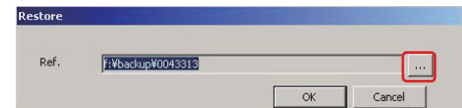

- 4 Click [OK].
The marking data restore process will start.

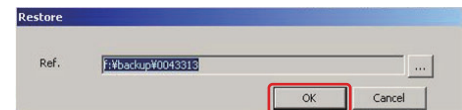

Precautions for Correct Use

When the restore function is executed, the data on the system will be overwritten.

7.11 Installing TrueType Fonts

Installs the TrueType fonts saved in the USB memory to the system.

Additional Information

When TrueType fonts are installed, the system is automatically restarted to enable the installed fonts.

- 1 Connect the USB memory containing the TrueType fonts to the [MEMORY] connector on the system.

- 2 Click [Maintenance] on the menu bar, and then select [Install TrueType fonts]. The [Install TrueType fonts] dialog box is displayed.

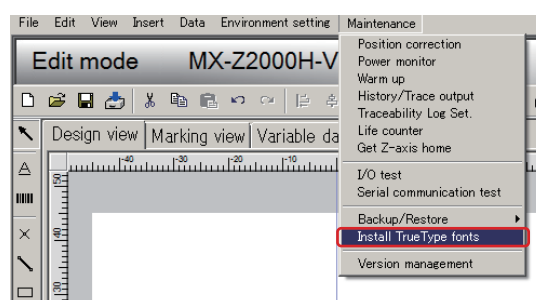

- 3 Click [Select device], and specify the folder in which the font to be installed is located.

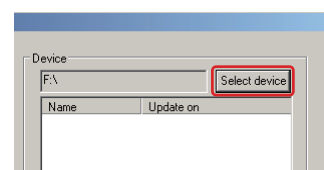

The font name is displayed in the [Device] list.

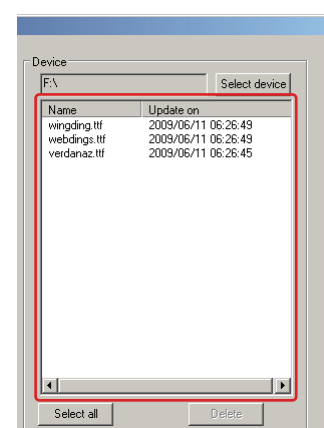

- 4 Select the font(s) to be installed to the system (multiple selection allowed), and click [Device to LM].**

The fonts on the [Device] list will be copied and saved to the [Laser marker unit] list.

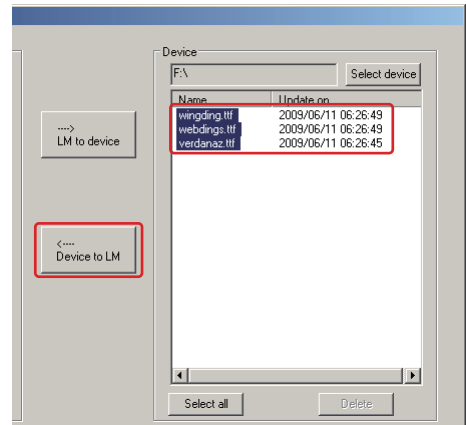

Additional Information

- To select all the fonts on the list, click [Select all].
- The TrueType fonts that are saved to the system can be saved to the USB memory. Select the font to be saved from the [Laser marker unit] list, and click [LM to Device] to save it.

- 5 Click [Close].**

- 6 Remove the USB memory from the [MEMORY] connector.**



Reference

For information on how to remove the USB memory, refer to:

- Steps 8 and on in "Saving the data to the USB memory" (Refer to page 1-9)

7.12 Version Management

Indicates the hardware and software information of the system.

- 1 Click **[Maintenance]** on the menu bar, and then select **[Version management]**.
The **[Version management]** dialog box is displayed.

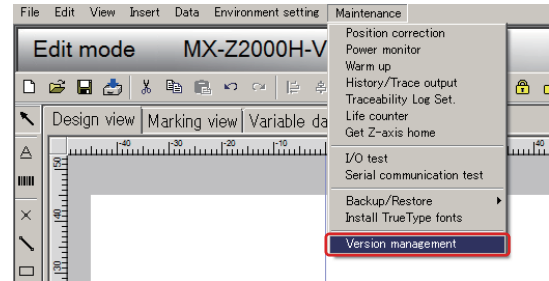

- 2 When the confirmation has been completed, click **[OK]**.

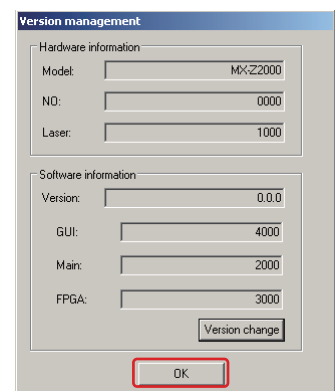

Additional Information

[Version change] is for maintenance only. This function does not usually need to be used.

Chapter 8

Operation and Control by Serial Communication

This chapter explains how to operate and control the system via serial communication by connecting external devices.

8.1	Serial Communications	8-2
8.2	Interface Specifications and Connection Examples	8-3
8.3	Data Format	8-9
8.4	Communication Procedure.....	8-12
8.5	Types of Communication Commands Used	8-13
8.6	Details of Communication Commands.....	8-16

8.1 Serial Communications

You can connect a PC, PLC or other external device to the controller using a serial communication cable and operate/control the system by sending and receiving commands and response messages between the external device and controller.

■ Controlling marking via a PLC

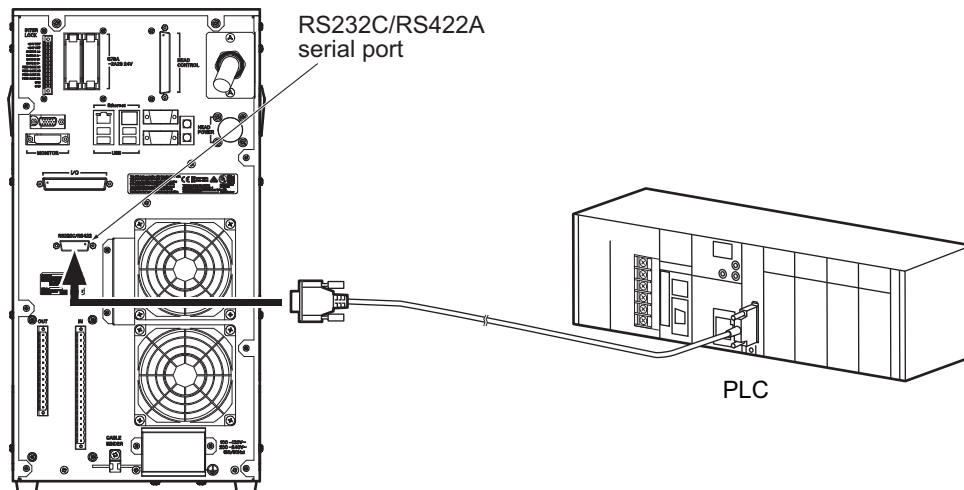

■ Controlling marking via a PC

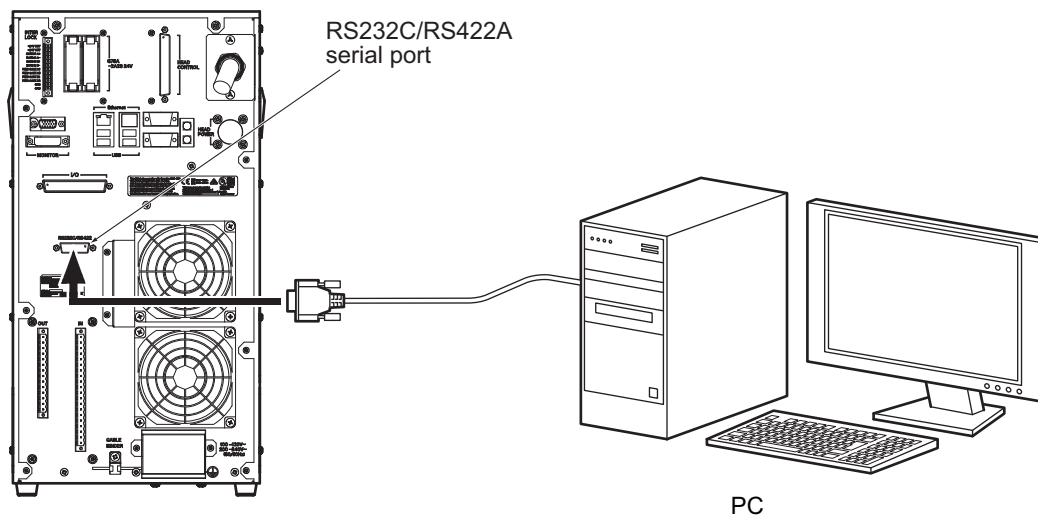



8.2 Interface Specifications and Connection Examples

This section explains the serial communication specifications and connection examples of each interface.

Serial Communication Specifications

The following explains the serial communication specifications.

Communication settings on the controller side are done with the marker software.

(Refer to "■ Communication setting method on the controller side (page 8-3)")

For the communication settings on the external device side, refer to the manual for the applicable device.

Note that the specifications of the connected external device must match the communication specifications listed below:

Item	Specification
Interface	RS-232C/RS-422A *
Full-duplex/half-duplex	Full-duplex communication
Synchronous method	Asynchronous method
Transmission control procedure	No procedure
Baud rate (bps)	9,600/19,200/38,400/57,600/115,200
Data bit length	7/8
Parity	None/EVEN (even number)/ODD (odd number)
Stop bit length	1/2

* RS-232C and RS-422A cannot be used at the same time.

If RS-422A is selected, one-to-one communication is performed and multi-drop connection is not supported.

■ Communication setting method on the controller side

1 Set the marker software to the [Edit mode] screen.

2 Click [Environment setting] on the menu bar, and then select [Marker operation].

The [Marker operation setting] dialog box is displayed.

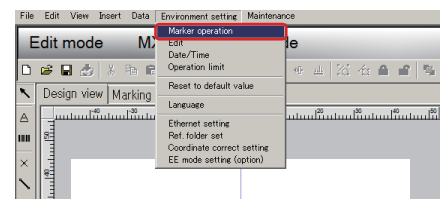

3 Select the [Communication] tab.

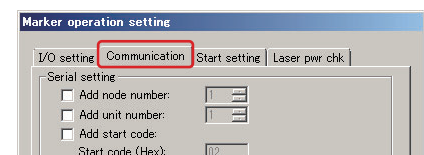

4 Set each item and click [OK].

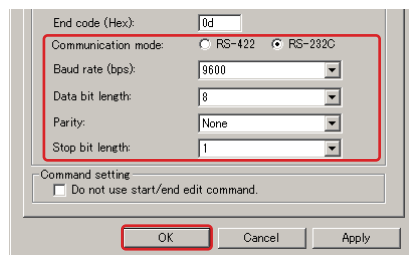

Reference

- "Serial Communication Setting (page 6-4)"

Connector Specifications

Connect the serial communication cable to the RS-232C/RS-422A serial port (D-sub, 15-pin connector) on the rear face of the controller.



Reference

For locations of RS-232C/RS-422A serial port, refer to:

- "Fiber Laser Marker MX-Z2000H-V1 series Setup Manual" (Z415)

D-sub, 15-pin (female)

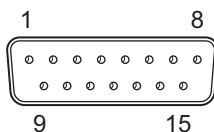

Application	Pin No.	Terminal name	Function
RS-232C	1	–	(Not used)
	2	RD (RXD)	Enters data from the external device.
	3	SD (TXD)	Outputs data from the controller.
	4	–	(Not used)
	5	–	(Not used)
	6	–	(Not used)
	7	SG (GND)	A signal ground. Connects the SG (GND) terminal on the external device.
	8	–	(Not used)
RS-422A	9	RDB (+)	Enters data from the external device.
	10	RDA (–)	Enters data from the external device.
	11	SDB (+)	Outputs data from the controller.
	12	SDA (–)	Outputs data from the controller.
	13	–	(Not used)
	14	–	(Not used)
	15	–	(Not used)

Precautions for Correct Use

- Do not connect anything to those pin numbers that are denoted "(Not used)." If these pins are connected by mistake, the system may fail.
- Do not use the RS-232C terminals and RS-422A terminals at the same time.

Additional Information

Even when RS-422A is selected, Pin No. 7 is still used as the SG (GND) terminal.

Additional Information

The following products are recommended for the connectors on the external device cable connected to the RS-232C/RS-422A serial port:

- Plug: OMRON XM3A-1521 (D-sub, 15-pin)
- Hood: OMRON XM2S-1511

Example of Connection with External Device

This shows an wiring example between the controller and the external devices. The wiring on the external device side will differ, depending on the specifications. Check the manual for the externally connected device in order to make the cables.

■ RS-232C interface

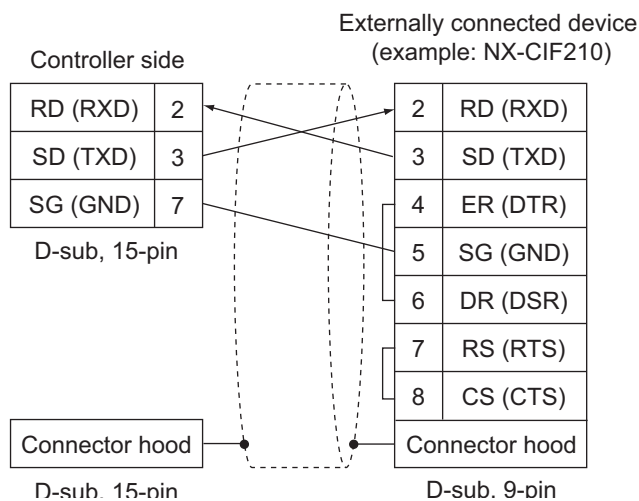

Precautions for Correct Use

Do not connect anything to those pins other than the pins No. 2, 3 or 7 on the controller side.

■ **RS-422A interface**

Cable wiring diagram

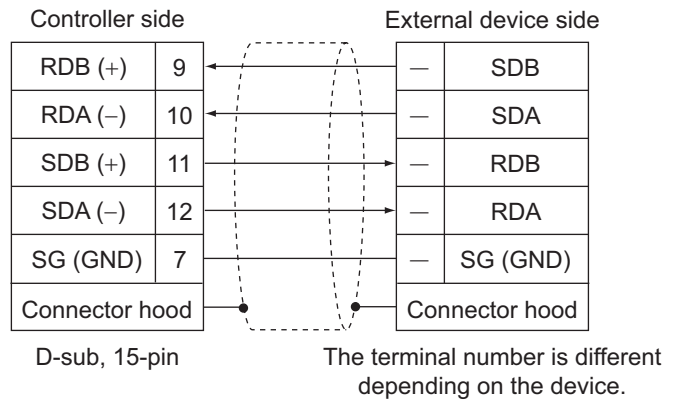
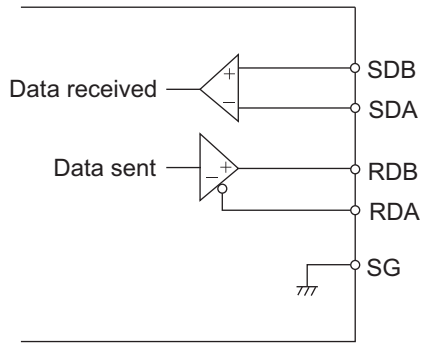

 **Precautions for Correct Use**

Do not connect anything to those pins other than the pins No. 7, 9, 10, 11 or 12 on the controller side.

Control Example of Serial Communications

The following explains the control example using the serial communications.

■ **Confirmation items**

- The breaker on the controller is turned ON.
- The key switch on the controller is turned ON.
- The [EMERGENCY A]/[EMERGENCY B] (emergency stop input A/B) terminal is short-circuited (turned ON).
- The controller is on the operation mode.

 **Precautions for Correct Use**

Serial commands and I/O commands are not accepted when the controller is in the edit mode.

■ **Operation command example**

The following explanation assumes the default laser marker communication settings. (Refer to "Serial Communication Setting (page 6-4)")

- Node number, unit number, start code, and check code are omitted.
- The end code is set to "CR (0x0d)."
- In the command example provided in a later section, SID represents "00." This setting is optional.
- Specify the setting according to the communication content.

 **Additional Information**

If the same command is duplicated when I/O communication control and serial communication control are performed simultaneously, the I/O communication control commands supersede the other.

● Control command example

The following is a flow from starting to shutter control and to marking control.

For shutter control, you need to select [Marker operation] - [I/O setting] tab from the menu bar, and then set [Shutter external command control] to [Yes]. (Refer to "● Operation setting (page 6-3)")

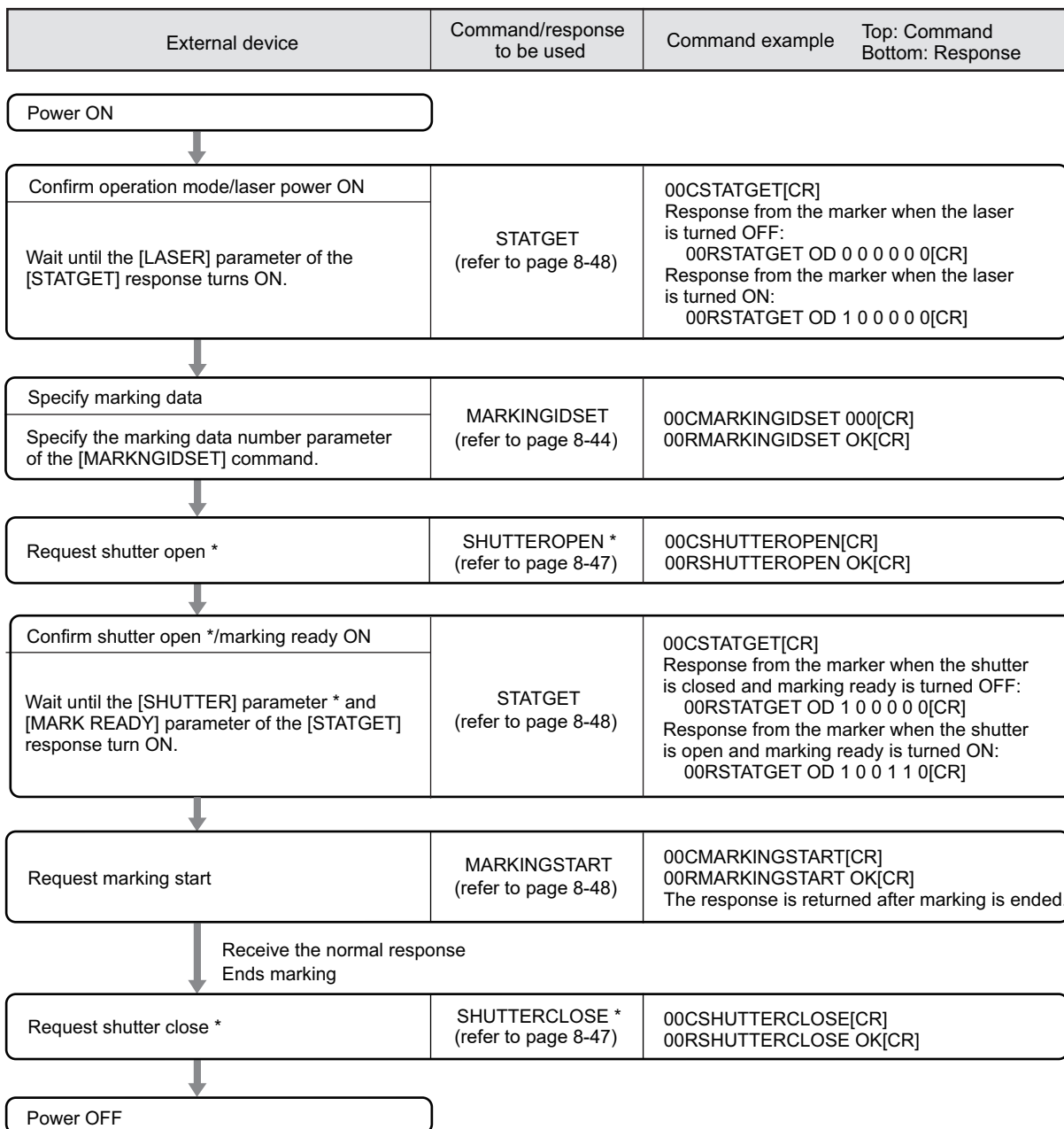

* When the shutter control is performed.



Additional Information

You can switch between processing laser and guide laser by specifying the "Guide laser setting" (GUIDEIDSET). After switching the setting, execute "Start marking" (MARKINGSTART). (Refer to "Guide Laser Setting - GUIDEIDSET (GDST) (page 8-46)" and "Marking Start - MARKINGSTART (MKSR) (page 8-48)")

■ **Marking data edit command example**

The following is a flow of changing the string content from "A" to "B" for marking data No. 000 and block No. 0000.

Note that the "Start edit" (EDITRESERVEON) command and the "End edit" (EDITRESERVEOFF) command must be executed before and after any of the commands that are categorized as an edit command.

External device	Command/response to be used	Command example	Top: Command Bottom: Response
Instruct editing start Specify the editing start using this command.	EDITRESERVEON (refer to page 8-17)	00CEDITRESERVEON[CR] 00REDITRESERVEON OK[CR]	
Acquire marking data number Confirm the marking data number of the block to be edited.	MARKINGIDGET (refer to page 8-45)	00C MARKINGIDGET[CR] 00R MARKINGIDGET OD 000[CR] Indicates that the current marking data number is No. 000.	
Acquire block set value Acquire the set value for the block number 0000.	EDITBLOCKGET (refer to page 8-28)	00CEDITBLOCKGET 0000[CR] 00REDITBLOCKGET OD 1 0 0 0 1000 1000 A[CR] Indicates that the string for the current block number 0000 is "A." (Refer to "Additional Information" below.)	
Edit block set value Send the response data by changing the data from "A" to "B" and specifying the block number 0000 to be sent.	EDITBLOCKSET (refer to page 8-27)	00CEDITBLOCKSET 0000 1 0 0 0 1000 1000 B[CR] 00REDITBLOCKSET OK[CR] (Refer to "Additional Information" below.)	
Save edited content. Save the edited content using this command. The edited content will be deleted if you restart the controller without executing this command.	MARKINGDATASAVE (refer to page 8-17)	00CMARKINGDATASAVE[CR] 00RMARKINGDATASAVE OK[CR]	
Instruct editing end The edited content is applied in the marker by this command.	EDITRESERVEOFF (refer to page 8-17)	00CEDITRESERVEOFF[CR] 00REDITRESERVEOFF OK[CR]	



Additional Information

When not changing the parameter value by using the current set value in an edit command, the parameter can be omitted by using "*".

In the command example above, only the string that is to be changed can be specified as shown below. (The block value setting does not need to be obtained.)

00CEDITBLOCKSET 0000 * * * * * B[CR]

For details, refer to the explanation of each command.

8.3 Data Format

This section explains the data format used to control the serial communications.

ASCII code is used in general for text used in communications when the communication is controlled via an external device.

Message Format

The structure of messages used for serial communication is as follows.

Start code (1 byte, can be omitted)	Node number (3 bytes, can be omitted)	Unit number (3 bytes, can be omitted)	Command/response data (variable)	End code (1 or 2 bytes)	Check code (1, 2 or 4 bytes, can be omitted)
--	--	--	-------------------------------------	----------------------------	---

Item	Can be omitted Yes/No	Explanation
Start code	Yes	Indicates the start of the message. Content: Any ASCII characters excluding ACK(0x06), NAK (0x15), EOT (0x04), and end code. Size: 1 byte Default: Omitted
Node number	Yes	Indicates the node number. Content: ASCII character representing "%" + node number. Size: 3 bytes (including "%") Default: Omitted
Unit number	Yes	Indicates the unit number. Content: ASCII character representing "\$" + unit number. Size: 3 bytes (including "\$") Default: Omitted
Command/response data	No	Command or response data (Refer to " Command/Response Data (page 8-10)")
End code	No	Indicates the end of the data. Content: Any ASCII code between 0x00 and 0x1F. *A code that is the same as the start code cannot be specified. Size: 1 byte or 2 bytes Default: 1 byte, CR (0x0d)
Check code	Yes	Indicates a code that checks for message corruption. (Refer to "■ Detail of check code (page 8-10)") Size: ASCII 4 or 2 bytes Binary 2 bytes or 1 byte Default: Omitted

■ Detail of check code

Check code type	Description
CRC	<ul style="list-style-type: none"> Targets data between the start code and the end code. CRC-16-CCITT (Generating polynomial: $X^{16} + X^{12} + X^5 + 1$ (0x1021)) When the size is 1, the lower byte of the calculation result (16-bit) When the size is 2, the upper byte + lower byte of the calculation result (16-bit)
BCC	<ul style="list-style-type: none"> Targets data between the start code and the end code. XOR value for every 2 bytes 0x00 is added at the end if the message length is an odd byte. When the size is 1, the upper byte of the calculation result (16-bit) When the size is 2, the lower byte + upper byte of the calculation result (16-bit)
SUM	<ul style="list-style-type: none"> Targets data between the start code and the end code. Sum per 1 byte 0x00 is added at the end if the message length is an odd byte. When the size is 1, the lower byte of the calculation result (16-bit) When the size is 2, the upper byte + lower byte of the calculation result (16-bit)



Additional Information

When setting the check code in binary, set it in the byte order of big endian.

Command/Response Data

The structure of command or response data used for serial communication control is as follows.

■ Basic format (ASCII string)

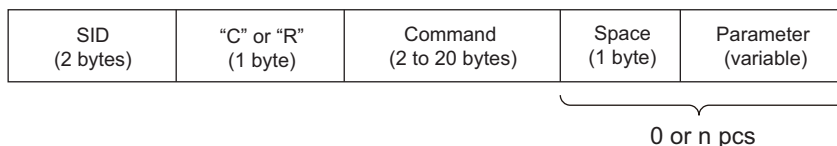

Item	Description
SID	Specifies any number between "00" and "99" for a command. Specifies the same SID as that of the command for a response.
"C" or "R"	Specifies "C" for a command. Specifies "R" for a response.
Command	Specifies a command string for a command. Specifies the same command string as that of the command for a response.
Space + Parameter	Specifies the value corresponding to the command or response.

**Additional Information**

- Use ASCII characters for the numeric value to be specified for a command or response unless otherwise specified.
- Numeric data is expressed in decimal or hex, and "0x" is added at the beginning of the number if it is a hex value.
- A to F can be upper- or lower-case.

(Example)

Numerical value data	Storage data
21	0x32, 0x31
0x12AB	0x30, 0x78, 0x31, 0x32, 0x41, 0x42 or 0x30, 0x78, 0x31, 0x32, 0x61, 0x62

■ Command/response format example

Command without parameter

SID (2 bytes)	"C" (1 byte)	Command (2 to 20 bytes)
------------------	-----------------	----------------------------

Command with parameter

SID (2 bytes)	"C" (1 byte)	Command (2 to 20 bytes)	Space (1 byte)	Parameter (variable)
------------------	-----------------	----------------------------	-------------------	-------------------------

Response without parameter (normal)

SID (2 bytes)	"R" (1 byte)	Command (2 to 20 bytes)	Space (1 byte)	"OK" (2 bytes)
------------------	-----------------	----------------------------	-------------------	-------------------

Response with parameter (normal)

SID (2 bytes)	"R" (1 byte)	Command (2 to 20 bytes)	Space (1 byte)	"OD" (2 bytes)	Space (1 byte)	Parameter (variable)
------------------	-----------------	----------------------------	-------------------	-------------------	-------------------	-------------------------

Error response

SID (2 bytes)	"R" (1 byte)	Command (2 to 20 bytes)	Space (1 byte)	"EN" (2 bytes)	Space (1 byte)	Error code (variable)
------------------	-----------------	----------------------------	-------------------	-------------------	-------------------	--------------------------

**Additional Information**

Response when an unidentifiable command is received

When SID or the command cannot be identified due to a fatal error in the message format, size, etc. of the received command, a response with the following value is returned.

(Example)

Item	Description
Node number	"%00"
Unit number	"\$00"
SID	"00"
"C" or "R"	"R"
Command	"UNKOWN"

8.4 Communication Procedure

This section explains the communication procedure between the controller and external devices via serial communication control.

Basic Communication Procedure

An external device sends a command to the controller, which then returns a response back to the external device.

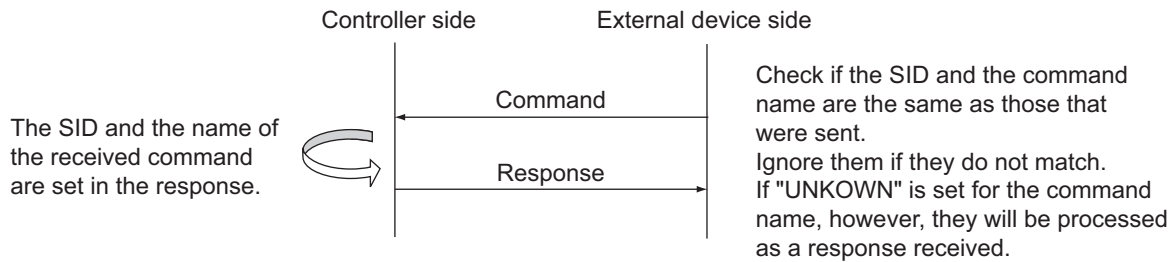

Additional Information

The external device cannot issue the next command after sending a command until it receives a response from the controller. Some commands that are urgent, however, can be sent before a response is received. In such a case, the controller receives and executes both commands, but the response may not necessarily be sent back in the order of the commands issued. Commands that are urgent include the "Marking stop" (MARKINGSTOP) command.

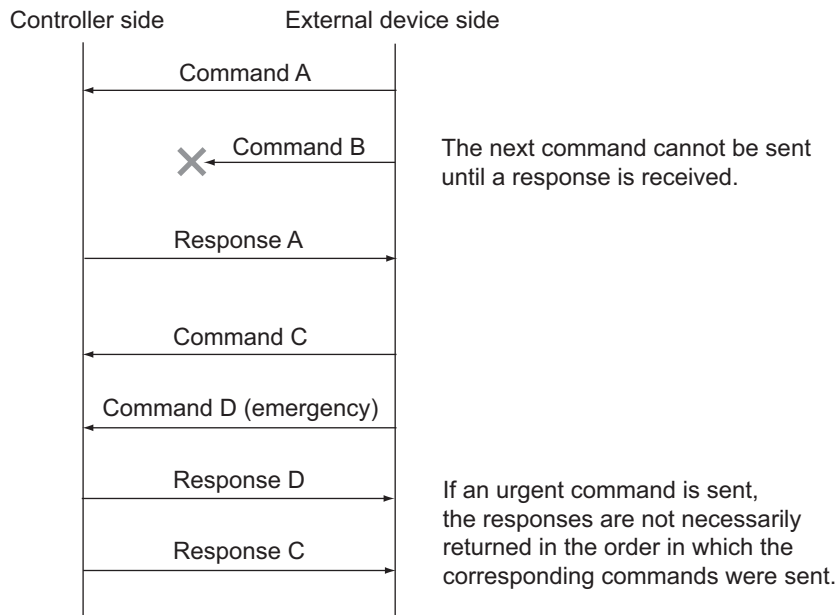

8.5 Types of Communication Commands Used

The following is a list of communication commands used in serial communication control.

For the details of each communication command, refer to the applicable page(s) in "8.6 Details of Communication Commands (page 8-16)".



Precautions for Correct Use

- When saving the communication settings, execute the "Save edited data" (MARKINGDATASAVE) command. (Refer to "Save Edited Data - MARKINGDATASAVE (MKSX) (page 8-17)")
- For marking data edit commands (those that include EDIT in the command name), execute "Start edit" (EDITRESERVEON) command before issuing the command, and the "End edit" (EDITRESERVEOFF) command after issuing the command. (Refer to "Start Edit - EDITRESERVEON (RVON) (page 8-17)" and "End Edit - EDITRESERVEOFF (RVOF) (page 8-17)")
- For the marking data edit commands marked with * in the table below, the start edit command (EDITRESERVEON) and end edit command (EDITRESERVEOFF) can be omitted by selecting [Do not use start/end edit command] in [Command setting]. (Refer to "Serial Communication Setting (page 6-4)".
- The operation commands marked with ** in the following table are supported in Ethernet and EtherNet/IP™ communications.

Command name	Abbreviated from	Function	Reference page	
Error processing				
Cancel error	ERRRESET	ERRT	Cancels errors and alarms.	8-16
Acquire error	ERRGET	ERGT	Acquires errors and alarms.	8-16
Saving marking data				
Save edited data	MARKINGDATASAVE	MKSX	Saves the edited marking data	8-17
Editing the marking data				
Start edit	EDITRESERVEON	RVON	Starts editing the marking data.	8-17
End edit	EDITRESERVEOFF	RVOF	Ends editing the marking data.	8-17
Marking parameter setting*	EDITMARKINGSET	MHST	Sets the parameter for the marking data (common setting).	8-18
Marking parameter acquisition	EDITMARKINGGET	MHGT	Acquires the setting of the parameter for the marking data (common setting).	8-20
Pallet parameter setting *	EDITPACKAGESET	PKST	Sets the pallet parameter for the marking data.	8-22
Pallet parameter acquisition	EDITPACKAGEGET	PKGT	Acquires the setting of the pallet parameter for the marking data.	8-24
Cell parameter setting *	EDITPACKAGECELLSET	PCST	Sets the cell parameter for the marking data.	8-25
Cell parameter acquisition	EDITPACKAGECELLGET	PCGT	Acquires the setting of the cell parameter for the marking data.	8-26
Block parameter setting *	EDITBLOCKSET	BLST	Sets the block parameter for the marking data.	8-27
Block parameter acquisition	EDITBLOCKGET	BLGT	Acquires the setting of the block parameter for the marking data.	8-28
Layer parameter setting	EDITLAYERPARAMSET	LPST	Marking data layer parameter settings	8-29
Layer parameter acquisition	EDITLAYERPARAMGET	LPGT	Marking data layer parameter acquisition	8-31
Specified block string setting *	EDITBLOCKSTRSET	BSST	Setting the string for the specified block number	8-32

Command name		Abbreviated from	Function	Reference page
Specified block string acquisition	EDITBLOCKSTRGET	BSGT	Acquiring the string for the specified block number	8-33
Batch cell marking enabling setting *	EDITENABLECELLSET	ECST	Enables marking of multiple cells that are specified.	8-33
Batch cell marking disabling setting *	EDITDISABLECELLSET	DCST	Disables marking of multiple cells that are specified.	8-33
Setting of a block of multiple strings *	EDITMULTIBLOCKSET	MBST	Sets the marking data for the multiple strings that are specified.	8-34
Marking content acquisition	MARKINGDATAGET	MDGT	Acquires the marking data for which the counter and the link have been converted.	8-34
Block processing parameter setting *	EDITBLOCKPARAMSET	BPST	Changes processing settings of the specified block.	8-35
Block processing parameter acquisition	EDITBLOCKPARAMGET	BPGT	Acquires the processing settings of the specified block.	8-36
Operation				
Marking data list	MARKINGLIST	MKLT	Acquires the marking data list.	8-36
Marking data name setting	MARKINGNAMESET	MNST	Marking data file name setting	8-37
Marking data name acquisition	MARKINGNAMEGET	MNGT	Marking data file name acquisition	8-37
Marking data information acquisition	MARKINGINFOGET	MKIF	Acquires the marking data information.	8-37
Block list	BLOCKLIST	BLLT	Acquires the block list.	8-38
Time hold setting	TIMEHOLDSET	THST	Sets the time hold.	8-38
Time hold status acquisition	TIMEHOLDGET	THGT	Acquires the time hold status.	8-39
Ctr setting	COUNTERSET	TUST	Sets the counter.	8-40
Counter setting acquisition	COUNTERGET	TUGT	Acquires the counter setting.	8-41
Count up	COUNTERUP	TUUP	Counts up the counter.	8-42
Counter reset	COUNTERRESET	TURT	Sets the counter to initial value.	8-42
Counter status acquisition	COUNTERSTATGET	TUTT	Acquires the counter status.	8-43
Variable data table index specification	FLEXTABLESET	FXST	Specifies the variable data table number and index number.	8-44
Variable data table index acquisition	FLEXTABLEGET	FXGT	Specifies the variable data table number and index number.	8-44
Marking data No. specification	MARKINGIDSET	MKST	Specifies the marking data number.	8-44
Marking data No. acquisition	MARKINGIDGET	MKGT	Acquires the marking data number.	8-45
Position correction value setting	OFFSETPARAMSET	OPST	Setting position correction offset value	8-45
Position correction value acquisition	OFFSETPARAMGET	OPGT	Acquiring position correction offset value	8-46
Guide laser setting	GUIDEIDSET	GDST	Sets the guide laser.	8-46
Guide laser acquisition	GUIDEIDGET	GDGT	Acquires the setting of the guide laser.	8-47
Open the shutter	SHUTTEROPEN	SHOP	Opens the shutter.	8-47
Close the shutter	SHUTTERCLOSE	SHCL	Closes the shutter.	8-47
Device status acquisition	STATGET	STGT	Acquires the device status.	8-48
Marking start	MARKINGSTART	MKSR	Starts the marking.	8-48
Marking stop	MARKINGSTOP	MKSP	Stops the marking.	8-48
Warm-up start	WARMUPSTART	WUSR	Starts the warm-up.	8-49
Device information setting	MACHINEINFOSET	MIST	Sets the device information that is displayed in the "Life Counter" function.	8-49

Command name		Abbreviated from	Function	Reference page
Device information acquisition	MACHINEINFOGET	MIGT	Acquires device information displayed in the "Life Counter" function.	8-50
Marking status acquisition **	MARKINGSTATUSGET	MSGT	Acquires the device status, including the marking status (MARK BUSY).	8-50
Drive information acquisition	DRIVEINFOGET	DIGT	Acquires the information of the drive connected to the system.	8-51
File data transfer	FILEDATATRANSFER	FTTR	Transfers data between the system and external devices.	8-52
Backup	MARKERDATABACKUP	MDBU	Backs up the data in the specified folder.	8-53
Restore	MARKERDATASTORE	MDRT	Restores data from the specified folder.	8-53
Power monitor measurement	MEASURELASERPOWER	MLPW	Acquires the measurement results for the internal power monitor.	8-53
Reference folder setting	REFERENCEFOLDERSET	RFST	Sets the specified folder as the reference folder.	8-54
Reference folder acquisition	REFERENCEFOLDERGET	RFGT	Acquires the path for the reference folder.	8-54
Marking data deletion	MARKINGDATADELETE	MKDT	Deletes the specified marking data.	8-54
Marker start setting change	MARKERSTARTUPSET	MUST	Changes the value of the start settings for the marker.	8-55
Marker start setting acquisition	MARKERSTARTUPGET	MUGT	Acquires the value of the start settings for the marker.	8-56
Laser power monitor setting change	LASERPOWERCHECKSET	LCST	Changes the laser power monitor setting.	8-57
Laser power monitor setting acquisition	LASERPOWERCHECKGET	LCGT	Acquires the value of the laser monitor setting.	8-58
Traceability log setting parameter change	TRACEABILITYPARAMSET	TBST	Changes the output setting for the traceability log setting.	8-59
Traceability log setting parameter acquisition	TRACEABILITYPARAMGET	TBGT	Acquires the output setting for the traceability log setting.	8-60
Traceability log setting acquisition	TRACELOGGET	TLGT	Acquires the most updated values that are output to the traceability log setting.	8-61
Environment setting and others				
Version acquisition	VERSIONGET	VRGT	Acquires the version information.	8-62
Date/time setting	DATETIMESET	DTST	Sets date/time	8-62
Date/time acquisition	DATETIMEGET	DTGT	Acquires the data and time.	8-62
Date and time setting with set parameters	DATEPARAMSET	DPST	Setting date and time according to set parameters.	8-63
Call back	CALLBACK	CLBK	Runs the data call back.	8-65
Power check execution	LASERPOWERCHECK	LPCK	Running a laser power check	8-65

8.6 Details of Communication Commands

This section explains the details of each communication command.

Note that commands can also be sent in abbreviated form (appended in ()).

Cancel Error - ERRRESET (ERRT)

■ Function

Cancels the error and alarms.

■ CommandParameter

Item	Size	Description
Target	1	0: Cancel all 1: Cancel error only 2: Cancel alarm only

■ Response parameter

None

Acquire Error - ERRGET (ERGT)

■ Function

Acquires the list of errors and alarms that are currently present.

■ Command parameter

None

■ Response parameter

Item	Size	Description
Error level_1	1	0: Alarm 1: Error B 2: Error A
Space (0x20)	1	---
Error code_1	Variable	Error/alarm codes
Space (0x20)	1	---
.		(Present data count: n)
.		
.		
Error level_n	1	0: Alarm 1: Error B 2: Error A
Space (0x20)	1	---
Error code_n	Variable	Error/alarm codes

Save Edited Data - MARKINGDATASAVE (MKSU)**■ Function**

Saves the changes made to the marking data so far.

All editing made will be deleted and the data before any editing was made will be restored if you restart the controller without executing this command.

■ Command parameter

None

■ Response parameter

None

8

Start Edit - EDITRESERVEON (RVON)**■ Function**

Turns OFF the marking ready status, and enables marking data editing.

When this command is executed, marking is not allowed until the "End edit" (EDITRESERVEOFF) command is executed. An error will occur in the edit mode.

■ Command parameter

None

■ Response parameter

None

End Edit - EDITRESERVEOFF (RVOF)**■ Function**

Applies the edit commands received after the "Start edit" (EDITRESERVEON) command was received, and transitions to the operation mode.

■ Command parameter

None

■ Response parameter

None

Marking Parameter Setting - EDITMARKINGSET (MHST)

■ Function

Specifies the marking settings (common settings) for the marking data currently set.
 The correction values for the marking parameter setting command are set for "Layer 0".
 This, however, is disabled during marking. An error will occur in the edit mode.
 Note that other parameters can be omitted using "*" when changing a particular set value only.

■ Command parameter

Item	Size	Description																	
Comment	Variable	Shift-JIS code Specify the Shift-JIS code according to the following examples.																	
		<table border="1"> <thead> <tr> <th>Comment description</th> <th>Command notation</th> <th>Explanation</th> </tr> </thead> <tbody> <tr> <td>ABC</td> <td>ABC</td> <td>If the following situations do not apply, " " are not necessary.</td> </tr> <tr> <td>ABC DEF</td> <td>"ABC DEF"</td> <td rowspan="2">Enclose the entire string with " " if the string includes a space or * (one character).</td> </tr> <tr> <td>*</td> <td>"*"</td> </tr> <tr> <td>ABC*DEF</td> <td>"ABC*DEF"</td> <td rowspan="2">For "(one character), enclose the string with " " and then enclose it with " " again.</td> </tr> <tr> <td>ABC"DEF</td> <td>"ABC""DEF"</td> </tr> </tbody> </table>		Comment description	Command notation	Explanation	ABC	ABC	If the following situations do not apply, " " are not necessary.	ABC DEF	"ABC DEF"	Enclose the entire string with " " if the string includes a space or * (one character).	*	"*"	ABC*DEF	"ABC*DEF"	For "(one character), enclose the string with " " and then enclose it with " " again.	ABC"DEF	"ABC""DEF"
		Comment description		Command notation	Explanation														
		ABC		ABC	If the following situations do not apply, " " are not necessary.														
		ABC DEF		"ABC DEF"	Enclose the entire string with " " if the string includes a space or * (one character).														
		*		"*"															
		ABC*DEF		"ABC*DEF"	For "(one character), enclose the string with " " and then enclose it with " " again.														
		ABC"DEF		"ABC""DEF"															
		To specify a text string consisting of multiple lines including "carriage return + line feed": - Insert CR(0x0d)+LF(0x0a) where you want to break the comment and move to the next line. - Change the end code to anything other than CR(0x0d).																	
		Space (0x20)		1	---														
Continuous count	Variable	0 to 65535, unit: Count 0 indicates infinite marking.																	
Space (0x20)	1	---																	
Interval	Variable	0 to 60000, unit: ms																	
Space (0x20)	1	---																	
Interval setting method	1	0: Start - Start 1: End - Start																	
Space (0x20)	1	---																	
End signal in continuation	1	0: OFF 1: ON																	
Space (0x20)	1	---																	
Marking direction	1	0: Left 1: Right 2: Up 3: Down This direction is based on the upper side of the character.																	
Space (0x20)	1	---																	
Mirror flip	1	0: OFF 1: Up/down 2: Left/right 3: Up/down/left/right																	
Space (0x20)	1	---																	
Optimization	1	0: OFF 1: Speed 2: Time																	

"*" can be placed to omit

Item	Size	Description	
Space (0x20)	1	---	*** can be placed to omit
Optimization time	Variable	0 to 600, unit: 1/10 s	
Space (0x20)	1	---	
X correction	Variable	MX-Z2000H-V1: -45000 to 45000 MX-Z2050H-V1/Z2055H-V1: -80000 to 80000 unit: 1/1000 mm	
Space (0x20)	1	---	
Y correction	Variable	MX-Z2000H-V1: -45000 to 45000 MX-Z2050H-V1/Z2055H-V1: -80000 to 80000 unit: 1/1000 mm	
Space (0x20)	1	---	
Z correction	Variable	-10000 to 10000, unit: 1/1000 mm	
Space (0x20)	1	---	
θZ correction	Variable	-4500 to 4500, unit: 1/100°	
Space (0x20)	1	---	
Trigger delay	Variable	0 to 10000, unit: ms	
Space (0x20)	1	---	
Power	Variable	10 to 100, unit: % multiplied by 10	
Space (0x20)	1	---	
Frequency	Variable	10 to 1000 (Standard mode) 10 to 100 (EE mode) Unit: kHz	
Space (0x20)	1	---	
Pulse shape	Variable	1 to 15 (Standard mode) 1 to 3 (EE mode)	
Space (0x20)	1	---	
Processing speed	Variable	1 to 12000, unit: mm/s	

■ Response parameter

None

Marking Parameter Acquisition - EDITMARKINGGET (MHGT)

■ Function

Acquires the marking set value (common setting) of the marking data currently set.

■ Command parameter

None

■ Response parameter

Item	Size	Description																
Comment	Variable	Shift-JIS code Specify the Shift-JIS code according to the following examples.																
		<table border="1"> <thead> <tr> <th>Comment description</th> <th>Command notation</th> <th>Explanation</th> </tr> </thead> <tbody> <tr> <td>ABC</td> <td>ABC</td> <td>If the following situations do not apply, " " are not necessary.</td> </tr> <tr> <td>ABC DEF</td> <td>"ABC DEF"</td> <td rowspan="2">Enclose the entire string with " " if the string includes a space or * (one character).</td> </tr> <tr> <td>*</td> <td>"**"</td> </tr> <tr> <td>ABC*DEF</td> <td>"ABC*DEF"</td> <td rowspan="2">For "(one character), enclose the string with " " and then enclose it with " " again.</td> </tr> <tr> <td>ABC"DEF</td> <td>"ABC""DEF"</td> </tr> </tbody> </table>	Comment description	Command notation	Explanation	ABC	ABC	If the following situations do not apply, " " are not necessary.	ABC DEF	"ABC DEF"	Enclose the entire string with " " if the string includes a space or * (one character).	*	"**"	ABC*DEF	"ABC*DEF"	For "(one character), enclose the string with " " and then enclose it with " " again.	ABC"DEF	"ABC""DEF"
		Comment description	Command notation	Explanation														
		ABC	ABC	If the following situations do not apply, " " are not necessary.														
		ABC DEF	"ABC DEF"	Enclose the entire string with " " if the string includes a space or * (one character).														
*	"**"																	
ABC*DEF	"ABC*DEF"	For "(one character), enclose the string with " " and then enclose it with " " again.																
ABC"DEF	"ABC""DEF"																	
Space (0x20)	1	---																
Continuous count	Variable	Unit: Count																
Space (0x20)	1	---																
Interval	Variable	Unit: ms																
Space (0x20)	1	---																
Interval setting method	1	0: Start - Start 1: End - Start																
Space (0x20)	1	---																
End signal in continuation	1	0: OFF 1: ON																
Space (0x20)	1	---																
Marking direction	1	0: Left 1: Right 2: Up 3: Down This direction is based on the upper side of the character.																
Space (0x20)	1	---																
Mirror flip	1	0: OFF 1: Up/down 2: Left/right 3: Up/down/left/right																
Space (0x20)	1	---																
Optimization	1	0: OFF 1: Speed 2: Time																
Space (0x20)	1	---																
Optimization time	Variable	Unit: 1/10 s																
Space (0x20)	1	---																
X correction	Variable	Unit: 1/1000 mm																
Space (0x20)	1	---																
Y correction	Variable	Unit: 1/1000 mm																
Space (0x20)	1	---																
Z correction	Variable	Unit: 1/1000 mm																
Space (0x20)	1	---																
θZ correction	Variable	Unit: 1/100°																

Item	Size	Description
Space (0x20)	1	---
Trigger delay	Variable	Unit: ms
Space (0x20)	1	---
Power	Variable	Unit: % multiplied by 10
Space (0x20)	1	---
Frequency	Variable	Unit: kHz multiplied by 10
Space (0x20)	1	---
Pulse shape	Variable	Pattern No.
Space (0x20)	1	---
Processing speed	Variable	Unit: mm/s

Pallet Parameter Setting - EDITPACKAGESET (PKST)

■ Function

Specifies the pallet settings for the marking data currently set.

Setting during marking is disabled. An error will occur in the edit mode.

Note that other parameters can be omitted using "*" when changing a particular set value only.

■ Command parameter

Item	Size	Description	
Pallet specification	1	0: Disabled 1: Enabled	
Space (0x20)	1	---	
Clipping position start point X	Variable	MX-Z2000H-V1: -45000 to 45000 MX-Z2050H-V1/Z2055H-V1: -80000 to 80000 Unit: 1/1000 mm	
Space (0x20)	1	---	
Clipping position start point Y	Variable	MX-Z2000H-V1: -45000 to 45000 MX-Z2050H-V1/Z2055H-V1: -80000 to 80000 Unit: 1/1000 mm	
Space (0x20)	1	---	
Clipping width	Variable	MX-Z2000H-V1: 1 to 90000 MX-Z2050H-V1/Z2055H-V1: 1 to 160000 Unit: 1/1000 mm	
Space (0x20)	1	---	
Clipping height	Variable	MX-Z2000H-V1: 1 to 90000 MX-Z2050H-V1/Z2055H-V1: 1 to 160000 Unit: 1/1000 mm	
Space (0x20)	1	---	
Clipping rotation angle	Variable	-4500 to 4500, unit: 1/100°	
Space (0x20)	1	---	"*" can be placed to omit
First position start point X	Variable	MX-Z2000H-V1: -45000 to 45000 MX-Z2050H-V1/Z2055H-V1: -80000 to 80000 Unit: 1/1000 mm	
Space (0x20)	1	---	
First position start point Y	Variable	MX-Z2000H-V1: -45000 to 45000 MX-Z2050H-V1/Z2055H-V1: -80000 to 80000 Unit: 1/1000 mm	
Space (0x20)	1	---	
Interval X	Variable	MX-Z2000H-V1: 0 to 90000 MX-Z2050H-V1/Z2055H-V1: 0 to 160000 Unit: 1/1000 mm	
Space (0x20)	1	---	
Interval Y	Variable	MX-Z2000H-V1: 0 to 90000 MX-Z2050H-V1/Z2055H-V1: 0 to 160000 Unit: 1/1000 mm	
Space (0x20)	1	---	
Number of cells X	Variable	1 to 255	
Space (0x20)	1	---	
Number of cells Y	Variable	1 to 255	
Space (0x20)	1	---	

Item	Size	Description	
Cell count-up direction	1	0: Lateral direction from upper left 1: Lateral direction from upper right 2: Lateral direction from down left 3: Lateral direction from down right 4: Vertical direction from upper left 5: Vertical direction from upper right 6: Vertical direction from down left 7: Vertical direction from down right	"" can be placed to omit
Space (0x20)	1	---	
Non-marking cells	1	0: Do not count up 1: Count up	

■ **Response parameter**

None

Pallet Parameter Acquisition - EDITPACKAGEGET (PKGT)**■ Function**

Acquires the pallet set values for the marking data currently set.
An error will occur in the edit mode.

■ Command parameter

None

■ Response parameter

Item	Size	Description
Pallet specification	1	0: Disabled 1: Enabled
Space (0x20)	1	---
Clipping position start point X	Variable	Unit: 1/1000 mm
Space (0x20)	1	---
Clipping position start point Y	Variable	Unit: 1/1000 mm
Space (0x20)	1	---
Clipping width	Variable	Unit: 1/1000 mm
Space (0x20)	1	---
Clipping height	Variable	Unit: 1/1000 mm
Space (0x20)	1	---
Clipping rotation angle	Variable	Unit: 1/100°
Space (0x20)	1	---
First position start point X	Variable	Unit: 1/1000 mm
Space (0x20)	1	---
First position start point Y	Variable	Unit: 1/1000 mm
Space (0x20)	1	---
Interval X	Variable	Unit: 1/1000 mm
Space (0x20)	1	---
Interval Y	Variable	Unit: 1/1000 mm
Space (0x20)	1	---
Number of cells X	Variable	1 to 255
Space (0x20)	1	---
Number of cells Y	Variable	1 to 255
Space (0x20)	1	---
Cell count-up direction	1	0: Lateral direction from upper left 1: Lateral direction from upper right 2: Lateral direction from down left 3: Lateral direction from down right 4: Vertical direction from upper left 5: Vertical direction from upper right 6: Vertical direction from down left 7: Vertical direction from down right
Space (0x20)	1	---
Non-marking cells	1	0: Do not count up 1: Count up

Cell Parameter Setting - EDITPACKAGECELLSET (PCST)

■ Function

Specifies the cell settings in the pallet of the marking data currently set.

Setting during marking is disabled. An error will occur in the edit mode.

Note that other parameters can be omitted using "*" when changing a particular set value only.
(The cell positions X and Y need to be specified.)

■ Command parameter

Item	Size	Description	
Cell position X	Variable	0 to 254	Cannot be omitted
Space (0x20)	1	---	
Cell position Y	Variable	0 to 254	Cannot be omitted
Space (0x20)	1	---	
Marking target	1	0: No 1: Yes	
Space (0x20)	1	---	
Enable count-up	1	0: Disabled 1: Enabled	
Space (0x20)	1	---	
X correction	Variable	MX-Z2000H-V1: -45000 to 45000 MX-Z2050H-V1/Z2055H-V1: -80000 to 80000 Unit: 1/1000 mm	*** can be placed to omit
Space (0x20)	1	---	
Y correction	Variable	MX-Z2000H-V1: -45000 to 45000 MX-Z2050H-V1/Z2055H-V1: -80000 to 80000 Unit: 1/1000 mm	
Space (0x20)	1	---	
Z correction	Variable	-10000 to 10000, unit: 1/1000 mm	
Space (0x20)	1	---	
θ Z correction	Variable	-18000 to 18000, unit: 1/100°	

■ Response parameter

None

Cell Parameter Acquisition - EDITPACKAGECELLGET (PCGT)**■ Function**

Acquires the set value of the marking data cell specified on the pallet.

■ Command parameter

Item	Size	Description
Cell position X	Variable	0 to 254
Space (0x20)	1	---
Cell position Y	Variable	0 to 254

■ Response parameter

Item	Size	Description
Marking target	1	0: No 1: Yes
Space (0x20)	1	---
Enable count-up	1	0: Disabled 1: Enabled
Space (0x20)	1	---
X correction	Variable	Unit: 1/1000 mm
Space (0x20)	1	---
Y correction	Variable	Unit: 1/1000 mm
Space (0x20)	1	---
Z correction	Variable	Unit: 1/1000 mm
Space (0x20)	1	---
θ Z correction	Variable	Unit: 1/100°

Block Parameter Setting - EDITBLOCKSET (BLST)



Precautions for Correct Use

When changing the block contents with this command

The marking position and shape may differ between software Ver4.1.x or later and software Ver4.0.x or earlier. Please check the marking content in advance.

■ Function

Specifies the settings of the specified block.

Note that settings during marking is disabled. An error will occur in the edit mode.

Note that other parameters can be omitted using "*" when changing a particular set value only. (The block number needs to be specified.)

■ Command parameter

Item	Size	Description															
Block No.	Variable	0 to 2047	Cannot be omitted														
Space (0x20)	1	---															
Marking target	1	0: No 1: Yes															
Space (0x20)	1	---															
Coordinate X	Variable	MX-Z2000H-V1: -90000 to 90000 MX-Z2050H-V1/Z2055H-V1: -160000 to 160000 Unit: 1/1000 mm															
Space (0x20)	1	---															
Coordinate Y	Variable	MX-Z2000H-V1: -90000 to 90000 MX-Z2050H-V1/Z2055H-V1: -160000 to 160000 Unit: 1/1000 mm															
Space (0x20)	1	---															
Rotation angle	Variable	0 to 35999, unit: 1/100°															
Space (0x20)	1	---															
Total width	Variable	MX-Z200H-V1: 1 to 90000 MX-Z2050H-V1/Z2055H-V1: 1 to 160000 Unit: 1/1000 mm	"*" can be placed to omit														
Space (0x20)	1	---															
Total height	Variable	MX-Z2000H-V1: 1 to 90000 MX-Z2050H-V1/Z2055H-V1: 1 to 160000 Unit: 1/1000 mm															
Space (0x20)	1	---															
Block content	Variable	String or image/graphic file name Specify the Shift-JIS code according to the following examples. <table border="1" data-bbox="687 1671 1190 1980"> <thead> <tr> <th>Block content</th> <th>Command notation</th> <th>Explanation</th> </tr> </thead> <tbody> <tr> <td>ABC</td> <td>ABC</td> <td>If the following situations do not apply, " " are not necessary.</td> </tr> <tr> <td>ABC DEF *</td> <td>"ABC DEF" **"</td> <td rowspan="2">Enclose the entire string with " " if the string includes a space or * (one character).</td> </tr> <tr> <td>ABC*DEF</td> <td>"ABC*DEF"</td> </tr> <tr> <td>ABC"DEF</td> <td>"ABC""DEF"</td> <td>For "(one character)", enclose the string with " " and then enclose it with " " again.</td> </tr> </tbody> </table>	Block content	Command notation	Explanation	ABC	ABC	If the following situations do not apply, " " are not necessary.	ABC DEF *	"ABC DEF" **"	Enclose the entire string with " " if the string includes a space or * (one character).	ABC*DEF	"ABC*DEF"	ABC"DEF	"ABC""DEF"	For "(one character)", enclose the string with " " and then enclose it with " " again.	
Block content	Command notation	Explanation															
ABC	ABC	If the following situations do not apply, " " are not necessary.															
ABC DEF *	"ABC DEF" **"	Enclose the entire string with " " if the string includes a space or * (one character).															
ABC*DEF	"ABC*DEF"																
ABC"DEF	"ABC""DEF"	For "(one character)", enclose the string with " " and then enclose it with " " again.															

■ Response parameter

None

Block Parameter Acquisition - EDITBLOCKGET (BLGT)**■ Function**

Acquires the set value of the specified block.

■ Command parameter

Item	Size	Description
Block No.	Variable	---

■ Response parameter

Item	Size	Description																	
Marking target	1	0: No 1: Yes																	
Space (0x20)	1	---																	
Coordinate X	Variable	Unit: 1/1000 mm																	
Space (0x20)	1	---																	
Coordinate Y	Variable	Unit: 1/1000 mm																	
Space (0x20)	1	---																	
Rotation angle	Variable	Unit: 1/100°																	
Space (0x20)	1	---																	
Total width ^{*1}	Variable	Unit: 1/1000 mm																	
Space (0x20)	1	---																	
Total height ^{*1}	Variable	Unit: 1/1000 mm																	
Space (0x20)	1	---																	
Block content ^{*1 *2}	Variable	<p>String or image/graphic file name</p> <p>Specify the Shift-JIS code according to the following examples.</p> <table border="1"> <thead> <tr> <th>Block content</th> <th>Command notation</th> <th>Explanation</th> </tr> </thead> <tbody> <tr> <td>ABC</td> <td>ABC</td> <td>If the following situations do not apply, " " are not necessary.</td> </tr> <tr> <td>ABC DEF</td> <td>"ABC DEF"</td> <td rowspan="2">Enclose the entire string with " " if the string includes a space or * (one character).</td> </tr> <tr> <td>*</td> <td>"**"</td> </tr> <tr> <td>ABC*DEF</td> <td>"ABC*DEF"</td> <td></td> </tr> <tr> <td>ABC"DEF</td> <td>"ABC""DEF"</td> <td>For "(one character), enclose the string with " " and then enclose it with " " again.</td> </tr> </tbody> </table>	Block content	Command notation	Explanation	ABC	ABC	If the following situations do not apply, " " are not necessary.	ABC DEF	"ABC DEF"	Enclose the entire string with " " if the string includes a space or * (one character).	*	"**"	ABC*DEF	"ABC*DEF"		ABC"DEF	"ABC""DEF"	For "(one character), enclose the string with " " and then enclose it with " " again.
Block content	Command notation	Explanation																	
ABC	ABC	If the following situations do not apply, " " are not necessary.																	
ABC DEF	"ABC DEF"	Enclose the entire string with " " if the string includes a space or * (one character).																	
*	"**"																		
ABC*DEF	"ABC*DEF"																		
ABC"DEF	"ABC""DEF"	For "(one character), enclose the string with " " and then enclose it with " " again.																	

*1 When the block type is "Fixed point", parameters are not returned.

*2 When the block type is "Line", "Rectangle", "Circle", or "Arc", parameters are not returned.

Layer Parameter Setting - EDITLAYERPARAMSET (LPST)

■ Function

Sets the layer for currently set marking data.

Note that other parameters can be omitted using * when changing only a particular set value. (The layer number must be set.)

■ Command parameter

Item	Size	Description	
Layer number	1	0 to 7	Cannot be omitted
Space (0x20)	1	---	
Layer setting	Variable	0: Plane 1: Column external (X) 2: Column external (Y) 3: Column internal (X) 4: Column internal (Y) 5: Cone external (X axis right vertex) 6: Cone external (X axis left vertex) 7: Cone external (Y axis top vertex) 8: Cone external (Y axis bottom vertex) 9: Cone external (Z axis vertex) 10: Cone internal (X axis right vertex) 11: Cone internal (X axis left vertex) 12: Cone internal (Y axis top vertex) 13: Cone internal (Y axis bottom vertex) 14: Cone internal (Z axis vertex) 15: Sphere external 16: Sphere internal	
Space (0x20)	1	---	
X-axis correction	Variable	MX-Z2000H-V1: - 45000 to 45000 MX-Z2050H-V1/Z2055H-V1: - 80000 to 80000 Unit: 1/1000 mm	"*" can be placed to omit
Space (0x20)	1	---	
Y-axis correction	Variable	MX-Z2000H-V1: - 45000 to 45000 MX-Z2050H-V1/Z2055H-V1: - 80000 to 80000 Unit: 1/1000 mm	
Space (0x20)	1	---	
Z-axis correction	Variable	-10000 to 10000 Unit: 1/1000 mm	
Space (0x20)	1	---	
θX correction	Variable	-9000 to 9000 Unit: 1/100°	
Space (0x20)	1	---	
θY correction	Variable	-9000 to 9000 Unit: 1/100°	
Space (0x20)	1	---	
θZ correction	Variable	-4500 to 4500 Unit: 1/100°	
Space (0x20)	1	---	
Radius	Variable	1 to 999999 Unit: 1/1000 mm	
Space (0x20)	1	---	
Number of surface divisions	Variable	4 to 50	

Item	Size	Description	
Space (0x20)	1	---	
Height	Variable	1 to 999999 Unit: 1/1000 mm	
Space (0x20)	1	---	
Large circle radius	Variable	1 to 999999 Unit: 1/1000 mm	
Space (0x20)	1	---	
Small circle radius	Variable	1 to 999999 Unit: 1/1000 mm	
Space (0x20)	1	---	
Cone placement	1	0: Placed directly 1: Marking surface horizontal 2: Semi-cone	
Space (0x20)	1	---	
Lower circle radius	Variable	1 to 999999 Unit: 1/1000 mm	*** can be placed to omit
Space (0x20)	1	---	
Upper circle radius	Variable	1 to 999999 Unit: 1/1000 mm	
Space (0x20)	1	---	
Horizontal division count	Variable	4 to 50	
Space (0x20)	1	---	
Vertical division count	Variable	4 to 50	
Space (0x20)	1	---	
X radius	Variable	1 to 999999 Unit: 1/1000 mm	
Space (0x20)	1	---	
Y radius	Variable	1 to 999999 Unit: 1/1000 mm	
Space (0x20)	1	---	
Z radius	Variable	1 to 999999 Unit: 1/1000 mm	

■ Response parameter

None

Layer Parameter Acquisition - EDITLAYERPARAMGET (LPGT)

■ Function

Acquires the currently set marking data layer setting values.

■ Command parameter

Item	Size	Description
Layer number	1	0 to 7

■ Response parameter

Item	Size	Description
Layer number	1	0 to 7
Space (0x20)	1	---
Layer setting	Variable	0: Plane 1: Column external (X) 2: Column external (Y) 3: Column internal (X) 4: Column internal (Y) 5: Cone external (X axis right vertex) 6: Cone external (X axis left vertex) 7: Cone external (Y axis top vertex) 8: Cone external (Y axis bottom vertex) 9: Cone external (Z axis vertex) 10: Cone internal (X axis right vertex) 11: Cone internal (X axis left vertex) 12: Cone internal (Y axis top vertex) 13: Cone internal (Y axis bottom vertex) 14: Cone internal (Z axis vertex) 15: Sphere external 16: Sphere internal
Space (0x20)	1	---
X-axis correction	Variable	Unit: 1/1000 mm
Space (0x20)	1	---
Y-axis correction	Variable	Unit: 1/1000 mm
Space (0x20)	1	---
Z-axis correction	Variable	Unit: 1/1000 mm
Space (0x20)	1	---
θX correction	Variable	Unit: 1/100°
Space (0x20)	1	---
θY correction	Variable	Unit: 1/100°
Space (0x20)	1	---
θZ correction	Variable	Unit: 1/100°
Space (0x20)	1	---
Radius	Variable	Unit: 1/1000 mm
Space (0x20)	1	---
Number of surface divisions	Variable	4 to 50
Space (0x20)	1	---
Height	Variable	Unit: 1/1000 mm
Space (0x20)	1	---
Large circle radius	Variable	Unit: 1/1000 mm
Space (0x20)	1	---
Small circle radius	Variable	Unit: 1/1000 mm
Space (0x20)	1	---
Cone placement	1	0: Placed directly 1: Marking surface horizontal 2: Semi-cone

Item	Size	Description
Space (0x20)	1	---
Lower circle radius	Variable	Unit: 1/1000 mm
Space (0x20)	1	---
Upper circle radius	Variable	Unit: 1/1000 mm
Space (0x20)	1	---
Horizontal division count	Variable	4 to 50
Space (0x20)	1	---
Vertical division count	Variable	4 to 50
Space (0x20)	1	---
X radius	Variable	Unit: 1/1000 mm
Space (0x20)	1	---
Y radius	Variable	Unit: 1/1000 mm
Space (0x20)	1	---
Z radius	Variable	Unit: 1/1000 mm

Specified Block String Setting - EDITBLOCKSTRSET (BSST)

■ Function

Sets the character string marked for the specified block number.

■ Command parameter

Item	Size	Description
Block No.	Variable	0 to 2047
Space (0x20)	1	---
Marked string	Variable	0 to 512, in units of characters

■ Response parameter

None

Specified Block String Acquisition - EDITBLOCKSTRGET (BSGT)**■ Function**

Acquires the character string marked for the specified block number.

■ Command parameter

Item	Size	Description
Block No.	Variable	0 to 2047

■ Response parameter

Item	Size	Description
Marked string	Variable	0 to 512, in units of characters

8

Batch Cell Marking Enabling Setting - EDITENABLECELLSET (ECST)**■ Function**

Enables marking of multiple cells during pallet marking.

Up to 18 cells can be specified each time the command is executed.

■ Command parameter

Item	Size	Description
Number of applicable cells	Variable	Number of enabled cells (1 to 18)
Space (0x20)	1	---
Cell number	Variable	Cell number to be enabled
Space (0x20)	1	---
.		
.		(Number of cells to be set: n)
.		

■ Response parameter

None

Batch Cell Marking Disabling Setting - EDITDISABLECELLSET (DCST)**■ Function**

Disables marking of multiple cells during pallet marking.

Up to 18 cells can be specified each time the command is executed.

■ Command parameter

Item	Size	Description
Number of applicable cells	Variable	Number of disabled cells (1 to 18)
Space (0x20)	1	---
Cell number	Variable	Cell number to be disabled
Space (0x20)	1	---
.		
.		(Number of cells to be set: n)
.		

■ Response parameter

None

Setting of a Block of Multiple Strings - EDITMULTIBLOCKSET (MBST)**■ Function**

Specifies the strings for the multiple blocks that are specified.

Up to 10 blocks can be specified each time the command is executed. Note, however, that the total command length is limited to 128 bytes.

■ Command parameter

Item	Size	Description
Block number	Variable	Block number (0 to 2047)
Space (0x20)	1	---
String	Variable	String
Space (0x20)	1	---
.		
.		
.		(Number of blocks to be set: n)

■ Response parameter

None

Marking Content Acquisition - MARKINGDATAGET (MDGT)**■ Function**

Acquires the actual marking data content.

The data is converted based on the date/time data and control code, such as the counter and linked text, and the data to be actually marked is acquired.

■ Command parameter

Item	Size	Description
Block number	Variable	Block number (0 to 2047)

■ Response parameter

Item	Size	Description
Block number	Variable	Block number (0 to 2047)
Space (0x20)	1	---
String	Variable	Acquires the strings to be marked. (Example) String setting = %4Y01%%2M01%%2D01% (date: YYYYMMDD) ↓ String to be acquired = "20140217" (if the date is Feb. 17, 2014)

Block Processing Parameter Setting - EDITBLOCKPARAMSET (BPST)

■ Function

Sets the processing parameters (Power, Frequency, Pulse shape, Processing speed) for the specified block.

■ Command parameter

Item	Size	Description	
Block No.	Variable	Block number to set	Cannot be omitted
Space (0x20)			*** can be placed to omit
Power	Variable	1 to 1000, unit: %	
Space (0x20)			
Frequency	Variable	10 to 1000 (Standard mode) 10 to 100 (EE mode) Unit: kHz	
Space (0x20)			
Pulse shape	Variable	1 to 15 (Standard mode) 1 to 3 (EE mode)	
Space (0x20)			
Processing speed	Variable	1 to 12000, unit: mm/s	
Space (0x20)			
Power (Light module) *1	Variable	1 to 1000, unit: %	
Space (0x20)			
Frequency (Light module) *1	Variable	10 to 1000 (Standard mode) 10 to 100 (EE mode) Unit: kHz	
Space (0x20)			
Pulse shape (Light module) *1	Variable	1 to 15 (Standard mode) 1 to 3 (EE mode)	

*1 For QR codes and data matrices, the light module setting values are entered. For other blocks, the setting values are invalid.

■ Response parameter

None

Block Processing Parameter Acquisition - EDITBLOCKPARAMGET (BPGT)**■ Function**

Acquires the processing parameters (Power, Frequency, Pulse shape, Processing speed) for the specified block.

■ Command parameter

Item	Size	Description
Block No.	Variable	Block number to acquire

■ Response parameter

Item	Size	Description
Power	Variable	Unit: %
Space (0x20)		
Frequency	Variable	Unit: kHz
Space (0x20)		
Pulse shape	Variable	Pattern No.
Space (0x20)		
Processing speed	Variable	Unit: mm/s
Space (0x20)		
Power (Light module) *1	Variable	Unit: %
Space (0x20)		
Frequency (Light module) *1	Variable	Unit: kHz
Space (0x20)		
Pulse shape (Light module) *1	Variable	Pattern No.

*1 For QR codes and data matrices, the light module setting values are returned. For other blocks, "" is returned.

Marking Data List - MARKINGLIST (MKLT)**■ Function**

Acquires the marking data list.

The available data is only those that marking data number has been set.

■ Command parameter

None

■ Response parameter

Item	Size	Description
Marking data_1	Variable	Marking data No.
Space (0x20)	1	---
Marking data_2	Variable	Marking data No.
Space (0x20)	1	---
.		
.		(Present data count: n)
.		
Marking data_n	Variable	Marking data No.

Marking Data Name Setting - MARKINGNAMESET (MNST)**■ Function**

Open the marking data of the specified file name.

■ Command parameter

Item	Size	Description
File name	Variable	1 to 256, in units of characters

■ Response parameter

None

8

Marking Data Name Acquisition - MARKINGNAMEGET (MNGT)**■ Function**

Acquires the currently set marking data file name.

■ Command parameter

None

■ Response parameter

Item	Size	Description
File name	Variable	1 to 256, in units of characters

Marking Data Information Acquisition - MARKINGINFOGET (MKIF)**■ Function**

Acquires the specified marking data information.

■ Command parameter

Item	Size	Description
Marking data No.	Variable	Marking data number to acquire

■ Response parameter

Item	Size	Description
Comment	Variable	Expressed in shift JIS code
Space (0x20)	1	---
Overwrite protection	1	0: None 1: ON

Block List - BLOCKLIST (BLLT)**■ Function**

Acquires a list of blocks of marking data currently set.

■ Command parameter

None

■ Response parameter

Item	Size	Description
Block_1	Variable	Block No.
Space (0x20)	1	---
Block_2	Variable	Block No.
Space (0x20)	1	---
.		
.		(Present data count: n)
.		
Block_n	Variable	Block No.

Time Hold Setting - TIMEHOLDSET (THST)**■ Function**

Sets the time hold.

Use this to hold the date of the previous day when the internal clock of the controller passes 0 o'clock. Before the date changes, execute the "Time hold setting" command (Not specified: Command received date and time), or directly specify the date.

Setting during marking is disabled. Note also that this is immediately applied if the controller is in the marking ready status.

An error will occur in the edit mode.

■ Command parameter

Item	Size	Description
Date/time specification	1	0: Time hold reset 1: Not specified (Command received date and time) 2: Specified
Space (0x20)	1	---
Year/month/date/hour/ minute/second	Variable	"YYYYMMDDhhmmss" format used (Can be omitted if the "Date/time specification" is "0" or "1.")

■ Response parameter

None

Time Hold Status Acquisition - TIMEHOLDGET (THGT)**■ Function**

Acquires the time hold status.

■ Command parameter

None

■ Response parameter

Item	Size	Description
Date/time specification	1	0: No time hold 1: Time hold in process
Space (0x20)	1	---
Year/month/date/hour/ minute/second	14	"YYYYMMDDhhmmss" format used

Counter Setting - COUNTERSET (TUST)**■ Function**

Registers/sets the counter.

Setting during marking is disabled. Note also that this is immediately applied if the controller is in the marking ready status.

An error will occur in the edit mode.

Note that other parameters can be omitted using "*" when changing a particular set value only. (The counter number needs to be specified.)

■ Command parameter

Item	Size	Description	
Counter No.	1 to 2	0 to 15	Cannot be omitted
Space (0x20)	1	---	
Counter enabled/disabled	1	0: Disabled 1: Enabled	
Space (0x20)	1	---	
Initial value	Variable	Counter initial value	
Space (0x20)	1	---	
End value	Variable	Counter end value	
Space (0x20)	1	---	
Step	Variable	Number of counter steps	
Space (0x20)	1	---	
Current value	Variable	Current counter value	
Space (0x20)	1	---	
Initialization timing	1	0: Start marking 1: New sheet 3: Power ON 4: No initialization 5: Change marking data	*" can be placed to omit
Space (0x20)	1	---	
Count timing	1	0: Every marking 1: Every sheet 2: Every cell 3: Command change only	
Space (0x20)	1	---	
Count complete action	1	0: Error stop 1: Stop counter, resume at initial value. 2: Stop counter, resume at end value. 3: Auto-loop	
Space (0x20)	1	---	
Count complete output	1	0: OFF 1: A 2: B 3: C 4: D	
Space (0x20)	1	---	
Output type	1	0: Pulse 1: Level	

■ Response parameter

None

Counter Setting Acquisition - COUNTERGET (TUGT)

■ Function

Acquires the setting of the specified counter.

■ Command parameter

Item	Size	Description
Counter No.	1 to 2	0 to 15

■ Response parameter

Item	Size	Description
Enabled/disabled	1	0: Disabled 1: Enabled
Space (0x20)	1	---
Initial value	Variable	Counter initial value
Space (0x20)	1	---
End value	Variable	Counter end value
Space (0x20)	1	---
Step	Variable	Number of counter steps
Space (0x20)	1	---
Current value	Variable	Current counter value
Space (0x20)	1	---
Initialization timing	1	0: Start marking 1: New sheet 3: Power ON 4: No initialization 5: Change marking data
Space (0x20)	1	---
Count timing	1	0: Every marking 1: Every sheet 2: Every cell 3: Command change only
Space (0x20)	1	---
Count complete action	1	0: Error stop 1: Stop counter, resume at initial value. 2: Stop counter, resume at end value. 3: Auto-loop
Space (0x20)	1	---
Count complete output	1	0: OFF 1: A 2: B 3: C 4: D
Space (0x20)	1	---
Output type	1	0: Pulse 1: Level

Count Up - COUNTERUP (TUUP)

■ **Function**

Counts up/down the specified counter.

Setting during marking is disabled. Note also that this is immediately applied if the controller is in the marking ready status.

An error will occur in the edit mode.

■ **Command parameter**

Item	Size	Description																
Counter specification	Variable	Specifies 0x0000 to 0xFFFF for counters 0 to 15. (Specifies the bit equivalent to the counter from the least significant.) Upper Lower <table border="1" style="margin-left: auto; margin-right: auto;"> <tr> <td>15</td><td>14</td><td>13</td><td>12</td><td>11</td><td>10</td><td>9</td><td>8</td><td>7</td><td>6</td><td>5</td><td>4</td><td>3</td><td>2</td><td>1</td><td>0</td> </tr> </table> 0: Not specify 1: Specify	15	14	13	12	11	10	9	8	7	6	5	4	3	2	1	0
15	14	13	12	11	10	9	8	7	6	5	4	3	2	1	0			
Space (0x20)	1	---																
Count type		0: Count up 1: Count down																

■ **Response parameter**

None

Counter Reset - COUNTERRESET (TURT)

■ **Function**

Initializes the specified counter.

Setting during marking is disabled. Note also that this is immediately applied if the controller is in the marking ready status.

An error will occur in the edit mode.

■ **Command parameter**

Item	Size	Description																
Counter specification	Variable	Specifies 0x0000 to 0xFFFF for counters 0 to 15. (Specifies the bit equivalent to the counter from the least significant.) Upper Lower <table border="1" style="margin-left: auto; margin-right: auto;"> <tr> <td>15</td><td>14</td><td>13</td><td>12</td><td>11</td><td>10</td><td>9</td><td>8</td><td>7</td><td>6</td><td>5</td><td>4</td><td>3</td><td>2</td><td>1</td><td>0</td> </tr> </table> 0: Not specify 1: Specify	15	14	13	12	11	10	9	8	7	6	5	4	3	2	1	0
15	14	13	12	11	10	9	8	7	6	5	4	3	2	1	0			

■ **Response parameter**

None

Counter Status Acquisition - COUNTERSTATGET (TUTT)**■ Function**

Acquires the current counter status.

■ Command parameter

None

■ Response parameter

Item	Size	Description
Counter No. 0	1	0: Not used 1: In use 2: Count complete
Space (0x20)	1	---
Counter No. 1	1	Same as "Counter No. 0"
Space (0x20)	1	---
Counter No. 2	1	Same as "Counter No. 0"
Space (0x20)	1	---
Counter No. 3	1	Same as "Counter No. 0"
Space (0x20)	1	---
Counter No. 4	1	Same as "Counter No. 0"
Space (0x20)	1	---
Counter No. 5	1	Same as "Counter No. 0"
Space (0x20)	1	---
Counter No. 6	1	Same as "Counter No. 0"
Space (0x20)	1	---
Counter No. 7	1	Same as "Counter No. 0"
Space (0x20)	1	---
Counter No. 8	1	Same as "Counter No. 0"
Space (0x20)	1	---
Counter No. 9	1	Same as "Counter No. 0"
Space (0x20)	1	---
Counter No. 10	1	Same as "Counter No. 0"
Space (0x20)	1	---
Counter No. 11	1	Same as "Counter No. 0"
Space (0x20)	1	---
Counter No. 12	1	Same as "Counter No. 0"
Space (0x20)	1	---
Counter No. 13	1	Same as "Counter No. 0"
Space (0x20)	1	---
Counter No. 14	1	Same as "Counter No. 0"
Space (0x20)	1	---
Counter No. 15	1	Same as "Counter No. 0"

Variable Data Table Index Specification - FLEXTABLESET (FXST)**■ Function**

Sets the specified variable data table index number.
An error will occur in the edit mode.

■ Command parameter

Item	Size	Description
Table type	1	0: String 1: Image 2: Shape
Space (0x20)	1	---
Table No.	Variable	0 to 63
Space (0x20)	1	---
Index number	Variable	0 to 255

■ Response parameter

None

Variable Data Table Index Acquisition - FLEXTABLEGET (FXGT)**■ Function**

Acquires the current value of the specified variable data table index number.

■ CommandParameter

Item	Size	Description
Table type	1	0: String 1: Image 2: Shape
Space (0x20)	1	---
Table No.	Variable	Data table No.

■ Response parameter

Item	Size	Description
Index number	Variable	Index No.

Marking Data No. Specification- MARKINGIDSET (MKST)**■ Function**

Specifies the marking data number to perform marking.
An error will occur in the edit mode.

■ Command parameter

Item	Size	Description
Marking data No.	Variable	0 to 9999

■ Response parameter

None

Marking Data No. Acquisition - MARKINGIDGET (MKGT)**■ Function**

Acquires the marking data number of the marking data currently set.

■ Command parameter

None

■ Response parameter

Item	Size	Description
Marking data No.	Variable	Marking data No.

8

Position Correction Value Setting - OFFSETPARAMSET (OPST)**■ Function**

Sets the position correction.

■ Command parameter

Item	Size	Description
X axis	Variable	MX-Z2000H-V1: - 45000 to 45000 MX-Z2050H-V1/Z2055H-V1: - 80000 to 80000 Unit: 1/1000 mm
Space (0x20)	1	---
Y axis	Variable	MX-Z2000H-V1: - 45000 to 45000 MX-Z2050H-V1/Z2055H-V1: - 80000 to 80000 Unit: 1/1000 mm
Space (0x20)	1	---
Z axis	Variable	-10000 to 10000Unit: 1/1000 mm
Space (0x20)	1	---
θZ axis	Variable	-4500 to 4500 Unit: 1/100°

■ Response parameter

None

Position Correction Value Acquisition - OFFSETPARAMGET (OPGT)**■ Function**

Acquires the setting values for position correction.

■ Command parameter

None

■ Response parameter

Item	Size	Description
X axis	Variable	Unit: 1/1000 mm
Space (0x20)	1	---
Y axis	Variable	Unit: 1/1000 mm
Space (0x20)	1	---
Z axis	Variable	Unit: 1/1000 mm
Space (0x20)	1	---
θZ axis	Variable	Unit: 1/100°

Guide Laser Setting - GUIDEIDSET (GDST)**■ Function**

Sets the guide laser.

An error will occur in the edit mode.

■ Command parameter

Item	Size	Description
Guide laser type	Variable	0: Marking data (processing laser) 1: Marking area (guide laser) 2: Area guide (guide laser) 3: Center point (guide laser) 10: Marking data (guide laser) 15: Marking frame (guide laser) 16: Block frame (guide laser) 20: Focus guide (guide laser) * When the laser type set to guide laser, the marking count is set to infinite.
Space (0x20)	1	---
Display No.	Variable	0, 1, 2, 3, 10, 20: Omitted 15: Specifies "XY." X (column number), space, Y (row number) When "-1 -1" is specified, all cells are displayed. 16: Block number (0000 to 2047) When "-1" is specified, all blocks are displayed. * For information on how to specify the setting, refer to the explanations provided in the "Set cells" and the "Set blocks" in the [Test marking] dialog box. (Refer to "■ Setting (page 3-4)")

■ Response parameter

None

Guide Laser Acquisition - GUIDEIDGET (GDGT)**■ Function**

Acquires the guide laser mode.

■ Command parameter

None

■ Response parameter

Item	Size	Description
Guide laser type	Variable	0: Marking data (processing laser) 1: Marking area (guide laser) 2: Area guide (guide laser) 3: Center point (guide laser) 10: Marking data (guide laser) 15: Pallet cell frame (guide laser) 16: Block frame (guide laser) 20: Focus guide (guide laser)
Space (0x20)	1	---
Display No.	Variable	0, 1, 2, 3, 10, 20: None 15: X (column number), space, Y (row number) "-1 -1" indicates that all cells are specified. 16: Block number "-1" indicates that all blocks are specified.

8

Open the Shutter - SHUTTEROPEN (SHOP)**■ Function**

Opens the shutter.

Note that an error will occur if this command is executed in the edit mode or when the shutter is closed via I/O control.

No error will result if this command is executed when the shutter is already open.

■ Command parameter

None

■ Response parameter

None

Close the Shutter - SHUTTERCLOSE (SHCL)**■ Function**

Closes the shutter.

No error will result if this command is executed when the shutter is already closed.

■ Command parameter

None

■ Response parameter

None

Device Status Acquisition - STATGET (STGT)**■ Function**

Acquires the current controller status.

■ Command parameter

None

■ Response parameter

Item	Size	Description
Laser power (LASER)	1	0: OFF 1: ON
Marking stop (STOP)	1	0: OFF 1: ON
Error (ERROR)	1	0: OFF 1: ON
Shutter (SHUTTER) 0: OFF (close), 1: ON (open)	1	0: OFF 1: ON
Marking ready (MARK READY)	1	0: OFF 1: ON
Emergency stop	1	0: OFF 1: ON

Marking Start - MARKINGSTART (MKSR)**■ Function**

Starts marking.

Note that an error will occur if the marking ready status is not turned ON. An error will occur also during the edit mode.

■ Command parameter

None

■ Response parameter

None

Marking Stop - MARKINGSTOP (MKSP)**■ Function**

Notifies that the marking has stopped.

■ Command parameter

None

■ Response parameter

None

Warm-up Start - WARMUPSTART (WUSR)**■ Function**

Starts the warm-up.

This can be executed even if the marking ready status is not turned ON. An error will occur, however, if the warm up setting is not properly specified by the marker software. An error will occur also during the edit mode.

To stop the warm up process in the middle, use the "Marking stop" (MARKINGSTOP) command.

■ Command parameter

None

■ Response parameter

None

8

Device Information Setting - MACHINEINFOSET (MIST)**■ Function**

Specifies the information to be displayed in "Life Counter."

Note that other parameters can be omitted using "*" when changing a particular set value only. (The target needs to be specified.)

■ Command parameter

Item	Size	Description	
Target	1	1: Accumulated laser operation time 2: Operation time 3: Total marking time 4: Maintenance time 5: Button battery usage time	Cannot be omitted
Space (0x20)	1	---	
Current value	Variable	Target current value	"*" can be placed to omit
Space (0x20)	1	---	
Alarm	Variable	Target alarm set value	

■ Response parameter

None

Device Information Acquisition - MACHINEINFOGET (MIGT)**■ Function**

Acquires the information displayed in "Life Counter."

■ Command parameter

Item	Size	Description
Target	1	1: Accumulated laser operation time 2: Operation time 3: Total marking time 4: Maintenance time 5: Button battery usage time

■ Response parameter

Item	Size	Description
Target	1	1: Accumulated laser operation time 2: Operation time 3: Total marking time 4: Maintenance time 5: Button battery usage time
Space (0x20)	1	---
Current value	Variable	Target current value
Space (0x20)	1	---
Alarm	Variable	Target alarm set value

Marking Status Acquisition - MARKINGSTATUSGET (MSGT)**■ Function**

Acquires the marking status (device status) of the laser marker.
This command is a dedicated command for Ethernet communication.

■ Command parameter

None

■ Response parameter

Item	Size	Description
Marking (MARK BUSY)	1	0: OFF (Marking stopped) 1: ON (Marking)
Alarm (ALARM)	1	0: OFF 1: ON
Laser power (LASER)	1	0: OFF 1: ON
Error (ERROR)	1	0: OFF 1: ON
Shutter (SHUTTER)	1	0: OFF (close) 1: ON (open)
Marking ready (MARK READY)	1	0: OFF 1: ON
Emergency stop	1	0: OFF 1: ON

Drive Information Acquisition - DRIVEINFOGET (DIGT)**■ Function**

Acquires the information of the drive connected to the system.

■ Command parameter

None

■ Response parameter

Item	Size	Description
Drive information	Variable	Returns a comma-delimited list of the drives that are connected and available. (Example) If F drive is connected D,F

File Data Transfer - FILEDATATRANSFER (FTTR)**■ Function**

Copies all data with the specified extension in the specified folder or the specified files to a transfer folder.

The data will overwrite any existing data with the same name at the target location.

■ Command parameter

Item	Size	Description	
Type	1	Specifies the type of file to be transferred. 0: Marking data 1: Parts 2: Image 3: Graphic 4: Stroke font 5: Pattern 6: Counter 7: Variable data table 8: Date/Time variable data table	
Space (0x20)	1	---	Cannot be omitted
Path of the source of the transfer	Variable	Specifies the path of the source of the transfer. If a folder is specified with a path, all files of the specified type will be transferred. If a file name is specified, only the specified file will be transferred. (Example) • If path "F:\MarkerData" is specified All data of the specified type in the folder "F:\MarkerData" will be transferred. • If path "F:\MarkerData\000.lmp" is specified Only the "000.lmp" file will be transferred.	
Space (0x20)	1	---	
Path of the target transfer folder	Variable	Specifies the path of the target transfer folder. It is ignored even if specified by path up to file name. If it is omitted by "**", it is transferred to the data folder of the marker. The default path of the marker is "D:\LaserMarker\Data".	"**" can be placed to omit

■ Response parameter

Item	Size	Description
File count	Variable	Transferred file count

Backup - MARKERDATABACKUP (MDBU)**■ Function**

Backs up the data in the specified folder.

The backup unconditionally overwrites the data in the specified folder.

■ Command parameter

Item	Size	Description
Path of folder	Variable	Folder path for saving the backup data When this is omitted with "**", the data is saved in the marker default path. The marker default path is "F:\backup\{(Device ID)}"

"**" can be placed to omit

■ Response parameter

None

Restore - MARKERDATASTORE (MDRT)**■ Function**

Executes a restore of data from the specified folder path.

The restore unconditionally overwrites the data on the marker main unit.

■ Command parameter

Item	Size	Description
Path of folder	Variable	Folder path for the restore source data When this is omitted with "**", the data is restored from the marker default path. The marker default path is "F:\backup\{(Device ID)}"

"**" can be placed to omit

■ Response parameter

None

Power Monitor Measurement - MEASURELASERPOWER (MLPW)**■ Function**

Executes internal power monitor measurement and acquires the values measured.

■ Command parameter

None

■ Response parameter

Item	Size	Description
Measured	Variable	Unit: % This is the value when internal power monitor measurement was executed a certain number of times.

Reference Folder Setting - REFERENCEFOLDERSET (RFST)**■ Function**

Sets the reference folder.

■ Command parameter

Item	Size	Description
Path of reference folder	Variable	Full path of reference folder.

■ Response parameter

None

Reference Folder Acquisition - REFERENCEFOLDERGET (RFGT)**■ Function**

Acquires the path for the reference folder.

■ Command parameter

None

■ Response parameter

Item	Size	Description
Path of reference folder	Variable	Full path of reference folder.

Marking Data Deletion - MARKINGDATADELETE (MKDT)**■ Function**

Deletes the specified marking data.

■ Command parameter

Item	Size	Description
File name	Variable	File name for the marking data to delete

■ Response parameter

None

Marker Start Setting Change - MARKERSTARTUPSET (MUST)**■ Function**

Changes the start settings for the marker.

■ Command parameter

Item	Size	Description	
Date setting (starting day of the week)	1	0: Sunday 1: Monday	
Space (0x20)			
Start setting	1	0: Edit mode 1: Operation mode	
Space (0x20)			
Specify marking data	1	0: None 1: User specified file 2: Last used file	
Space (0x20)			
File name of marking data	Variable	File name of marking data.	
Space (0x20)			*** can be placed to omit
Change lock	1	0: No 1: Yes	
Space (0x20)			
Enable warm-up	1	0: Disabled 1: Enabled	
Space (0x20)			
Warm-up setting	1	0: User not specified 1: User specified	
Space (0x20)			
Warm-up file name	Variable	File name for the marking data used for warm-up.	
Space (0x20)			
Warm-up count	Variable	1 to 256, Unit: count	
Space (0x20)			
Warm-up interval	Variable	0 to 1000000, Unit: 1/1000 second	

■ Response parameter

None

Marker Start Setting Acquisition - MARKERSTARTUPGET (MUGT)**■ Function**

Acquires the contents of the start settings for the marker.

■ Command parameter

None

■ Response parameter

Item	Size	Description
Date setting (starting day of the week)	1	0: Sunday 1: Monday
Space (0x20)		
Start setting	1	0: Edit mode 1: Operation mode
Space (0x20)		
Specify marking data	1	0: None 1: User specified file 2: Last used file
Space (0x20)		
File name of marking data	Variable	File name of marking data.
Space (0x20)		
Change lock	1	0: No 1: Yes
Space (0x20)		
Enable warm-up	1	0: Disabled 1: Enabled
Space (0x20)		
Warm-up setting	1	0: User not specified 1: User specified
Space (0x20)		
Warm-up file name	Variable	File name for the marking data used for warm-up.
Space (0x20)		
Warm-up count	Variable	1 to 256, Unit: count
Space (0x20)		
Warm-up interval	Variable	0 to 1000000, Unit: 1/1000 second

Laser Power Monitor Setting Change - LASERPOWERCHECKSET (LCST)**■ Function**

Changes the contents of the laser power monitor settings.

■ Command parameter

Item	Size	Description	
Laser power check setting	1	0: Disabled 1: Enabled	*** can be placed to omit
Space (0x20)			
Threshold	Variable	10 to 200, Unit: %	
Space (0x20)			
Laser power chk	1	0: Only at start 1: Only at start marking 2: Only at end of marking 3: At start + at start marking 4: At start + at end of marking 5: At start + at start and end of marking 6: At start marking + at end of marking 7: None	
Space (0x20)			
Check timing	1	0: At each marking 1: Interval	
Space (0x20)			
Marking count	Variable	1 to 9999, unit: count	

■ Response parameter

None

Laser Power Monitor Setting Acquisition - LASERPOWERCHECKGET (LCGT)**■ Function**

Acquires the contents of the laser power monitor settings.

■ Command parameter

None

■ Response parameter

Item	Size	Description
Laser power check setting	1	0: Disabled 1: Enabled
Space (0x20)		
Threshold	Variable	10 to 200, Unit: %
Space (0x20)		
Laser power chk	1	0: Only at start 1: Only at start marking 2: Only at end of marking 3: At start + at start marking 4: At start + at end of marking 5: At start + at start and end of marking 6: At start marking + at end of marking 7: None
Space (0x20)		
Check timing	1	0: At each marking 1: Interval
Space (0x20)		
Marking count	Variable	1 to 9999, unit: count

Traceability Log Setting Parameter Change - TRACEABILITYPARAMSET (TBST)

■ Function

Specifies the output settings for the traceability log setting currently set.

Note that other parameters can be omitted using * when changing a particular set value only.

■ Command parameter

Item	Size	Description	
Target log output	Variable	Target log output	
Space (0x20)			
Output Info	1	0: Not output 1: Output	
Space (0x20)			
Marking data	1	0: Not output 1: Output	
Space (0x20)			
Counter Info	1	0: Not output 1: Output	
Space (0x20)			
Marking time	1	0: Not output 1: Output	
Space (0x20)			
Power check result	1	0: Not output 1: Output	
Space (0x20)			
Specification block	1	0: Not output 1: Output	*** can be placed to omit
Space (0x20)			
Block No.	Variable	Block No. Enabled when the specification block data information is set to "1".	
Space (0x20)			
Accumulated laser operation time	1	0: Not output 1: Output	
Space (0x20)			
Operation time	1	0: Not output 1: Output	
Space (0x20)			
Total marking time	1	0: Not output 1: Output	
Space (0x20)			
Maintenance time	1	0: Not output 1: Output	
Space (0x20)			
Button battery usage time	1	0: Not output 1: Output	

■ Response parameter

None

Traceability Log Setting Parameter Acquisition - TRACEABILITYPARAMGET (TBGT)

■ **Function**

Acquires the output setting values for the traceability log setting currently set.

■ **Command parameter**

None

■ **Response parameter**

Item	Size	Description
Target log output	Variable	Target log output
Space (0x20)	1	
Output Info	1	0: Not output 1: Output
Space (0x20)	1	
Marking data	1	0: Not output 1: Output
Space (0x20)	1	
Counter Info	1	0: Not output 1: Output
Space (0x20)	1	
Marking time	1	0: Not output 1: Output
Space (0x20)	1	
Power check result	1	0: Not output 1: Output
Space (0x20)	1	
Specification block	1	0: Not output 1: Output
Space (0x20)	1	
Block No.	Variable	Block No. Returns "" when no block No. is set.
Space (0x20)	1	
Accumulated laser operation time	1	0: Not output 1: Output
Space (0x20)	1	
Operation time	1	0: Not output 1: Output
Space (0x20)	1	
Total marking time	1	0: Not output 1: Output
Space (0x20)	1	
Maintenance time	1	0: Not output 1: Output
Space (0x20)	1	
Button battery usage time	1	0: Not output 1: Output

Traceability Log Setting Acquisition - TRACELOGGET (TLGT)

■ Function

Acquires the latest information on all contents that can be acquired with the traceability log setting.

■ Command parameter

None

■ Response parameter

Item	Size	Description
Marking data	Variable	Acquires marking data-related information. The display format is as follows: [Marking data name, Marking data No., Comment]
Space (0x20)	1	
Counter Info	Variable	Acquires counter information-related information. Enabled counters are all displayed. The display format is as follows: [Enable Counter No.: Current value]...[Enable Counter No._n: Current value]
Space (0x20)	1	
Marking time	Variable	Acquires marking data-related information. The display format is as follows: [Marking total time, Marking time] Unit: seconds
Space (0x20)	1	
Power check result	Variable	Acquires the power check results. The display format is as follows: [Power check result] Unit: %
Space (0x20)	1	
Specification block data information	Variable	When the specified block number is text or ID code, the set string is acquired. When the specified block number is image or diagram block, the set reference file path information is acquired. The display format is as follows: [Block No.: Block information string]
Space (0x20)	1	
Life counter	Variable	[Accumulated laser operation time, Operation time, Total marking time, Maintenance time, Button battery usage time] Unit: hour

Version Acquisition - VERSIONGET (VRGT)■ **Function**

Acquires the controller model, serial number, and the version of the controller internal part.

■ **Command parameter**

None

■ **Response parameter**

Item	Size	Description
Model	Variable	Model
Space (0x20)	1	---
Serial No.	Variable	Serial No.
Space (0x20)	1	---
Laser version	Variable	Laser version
Space (0x20)	1	---
Main software version	Variable	Main software version
Space (0x20)	1	---
FPGA version	Variable	FPGA version
Space (0x20)	1	---
GUI application version	Variable	GUI application version
Space (0x20)	1	---
Management version	Variable	Management version

Date/Time Setting - DATETIMESET (DTST)■ **Function**

Sets the date and time.

An error will occur in the edit mode.

■ **Command parameter**

Item	Size	Description
D/T	14	"YYYYMMDDhhmmss" format

■ **Response parameter**

None

Date/Time Acquisition - DATETIMEGET (DTGT)■ **Function**

Acquires the date and time.

■ **Command parameter**

None

■ **Response parameter**

Item	Size	Description
D/T	14	"YYYYMMDDhhmmss" format

Date and Time Setting with Set Parameters - DATEPARAMSET (DPST)**■ Function**

Set date and time according to the set parameters.

For parameters that require several settings, they can be omitted using an asterisk (*).

■ Command parameter

Item	Size	Description
Set parameters	1	Set the setting target. The date and time setting is changed according to the parameters set here. 0: YYYY MM DD hh mm ss (Year Month Day Hour Minute Second) 1: YYYY MM DD (Year Month Day) 2: hh mm ss (Hour Minute Second) 3: YYYY (Year) 4: MM (Month) 5: DD (Day) 6: hh (Hour) 7: mm (Minute) 8: ss (Second)
Space (0x20)	1	---

Item	Size	Description	
Value	Variable	The date and time are set according to the set parameters. <ul style="list-style-type: none"> • When the parameters set are 0, 1, and 3: The value of YYYY (Year) is set. • When the parameters set are 2 and 6: The value of hh (Hour) is set. • When the parameter set is 4: The value of MM (Month) is set. • When the parameter set is 5: The value of DD (Day) is set. • When the parameter set is 7: The value of mm (Minute) is set. • When the parameter set is 8: The value of ss (Second) is set. 	Can be omitted using an asterisk (*) depending on the set parameter.
Space (0x20)	1	---	
Value	Variable	The date and time are set according to the set parameters. <ul style="list-style-type: none"> • When the parameters set are 0 and 1: The value of MM (Month) is set. • When the parameter set is 2: The value of mm (Minute) is set. 	
Space (0x20)	1	---	
Value	Variable	The date and time are set according to the set parameters. <ul style="list-style-type: none"> • When the parameters set are 0 and 1: The value of DD (Day) is set. • When the parameter set is 2: The value of ss (Second) is set. 	
Space (0x20)	1	---	
Value	Variable	The date and time are set according to the set parameters. <ul style="list-style-type: none"> • When the parameter set is 0: The value of hh (Hour) is set. 	
Space (0x20)	1	---	
Value	Variable	The date and time are set according to the set parameters. <ul style="list-style-type: none"> • When the parameter set is 0: The value of mm (Minute) is set. 	
Space (0x20)	1	---	
Value	Variable	The date and time are set according to the set parameters. <ul style="list-style-type: none"> • When the parameter set is 0: The value of ss (Second) is set. 	

■ Response parameter

None

Call Back - CALLBACK (CLBK)**■ Function**

Returns a response containing the unchanged command data.

■ Command parameter

Item	Size	Description
Data	Variable	Data for performing the call back

■ Response parameter

Item	Size	Description
Data	Variable	Same as the sent data

Power Check Execution - LASERPOWERCHECK (LPCK)**■ Function**

Runs a laser power check.

If normal, returns "OK"; if the power check settings have not been made, returns an error.

■ Command parameter

None

■ Response parameter

None

Chapter 9

Operation and Control by Ethernet Communication

This chapter explains how to operate and control the system via Ethernet communication by connecting external devices.

9.1	Ethernet Communications.....	9-2
9.2	Interface Specifications	9-3
9.3	Data Format	9-4

9.1 Ethernet Communications

You can connect a PC, PLC or other external device to the controller using an Ethernet cable and operate/control the system by sending and receiving commands and response messages between the external device and controller. The Ethernet communication function of this system provides the same control environment as that with serial communication. The commands used for control are the same as those for serial communication. The configuration of command/response data, however, is slightly different between Ethernet and serial communications. Additionally, a header, such as the message size, needs to be added to the messages to be sent or received.

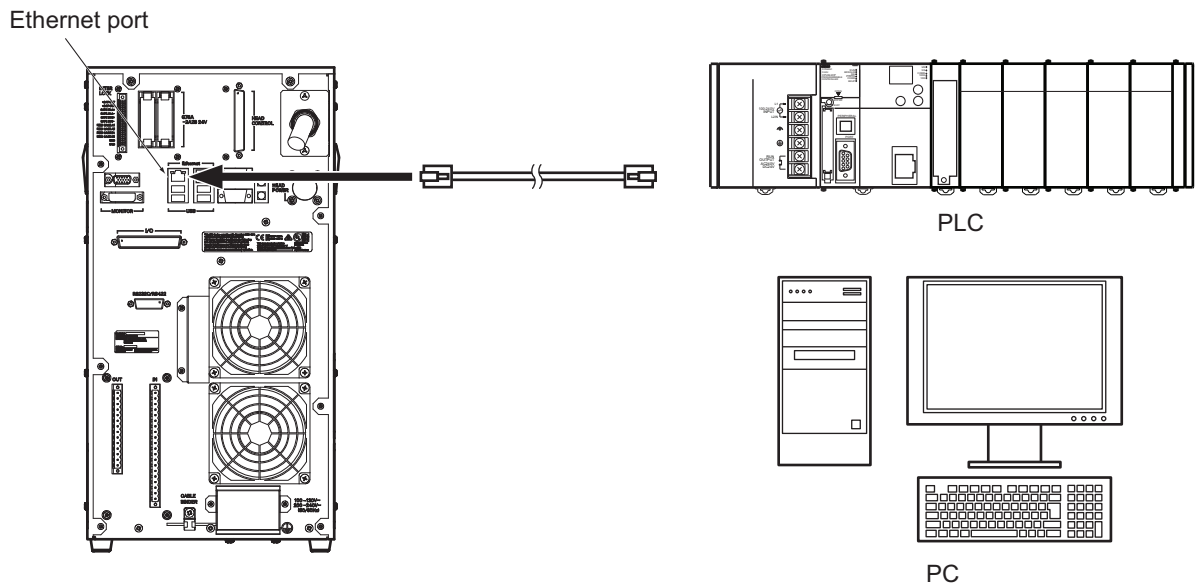

9.2 Interface Specifications

This section explains the specifications of the Ethernet communication and connector.

Ethernet Communication Specifications

The following explains the Ethernet communication specifications.

Communication settings on the controller side are done with the marker software.

For the communication settings on the connected device side, refer to the manual for the applicable device.

Note that the connected device must support the communication specifications listed below:

Item	Specification
Type	1000BASE-T/100BASE-TX / 10BASE-T
Compatible LAN cable	Category 5, 5e, 6 or 7

9

Connector Specifications

Connect the LAN cable to the Ethernet port (RJ-45, 8-pole modular connector) on the rear face of the controller.

Form: RJ-45 modular connector

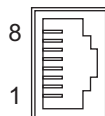

Pin No.	Terminal name	Function
1	TX (+)	Data sent (+)
2	TX (-)	Data sent (-)
3	RX (+)	Data received (+)
4	-	(Not used)
5	-	(Not used)
6	RX (-)	Data received (-)
7	-	(Not used)
8	-	(Not used)

9.3 Data Format

Command Format

Data is sent from an external device to the system in the following command format.

Header				Command/Response data (variable)
Send message size (4 bytes)	Send message No. (4 bytes)	Type (2 bytes)	Command No. (2 bytes)	

Item	Explanation
Send message size	Using a hexadecimal value specifies the total size for the header (12 bytes) and the command/response data.
Send message No.	Specifies any given number on the sender side. The system handles the specified value without making any particular judgment regarding the number.
Type	Specifies the message type on the sender side. "0x00" is always set for Ethernet no procedure messages.
Command No.	This is the number of the command to be executed. "0x00" is always set for Ethernet no procedure control.
Command/response data	Command or response data (Refer to " Command/Response Data (page 9-5)")



Additional Information

Each header item have to specified using a hexadecimal value.

Response Format

Responses are sent from the system to an external device in the following response format.

Header				Command/response data (variable)
Response message size (4 bytes)	Response message No. (4 bytes)	Type (2 bytes)	Command No. (2 bytes)	

Item	Explanation
Response message size	With a hexadecimal value returns the total size for the header (12 bytes) and the command/response data.
Response message No.	Returns the send message number set in the send command unchanged.
Type	Changes the type to a response type and returns in response to the message received. "0x01" is always returned in responses to Ethernet no procedure messages.
Command No.	Returns the command number received unchanged.
Command/response data	Command or response data (Refer to " Command/Response Data (page 9-5)")



Additional Information

Each header item responds with a hexadecimal value.

Command/Response Data

For Ethernet communication control, the same serial communication commands can be used. The configuration of command/response data, however, is different as follows.

■ Basic format (ASCII string)

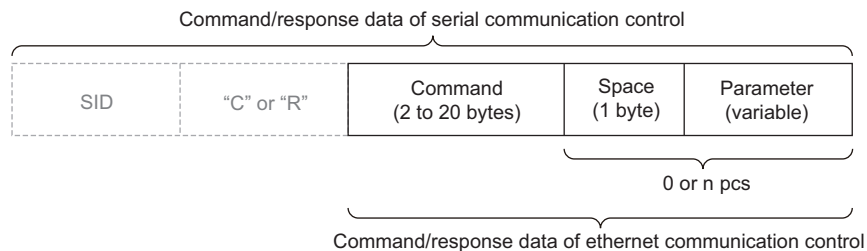

Item	Description
Command	Specifies a command string for a command. Specifies the same command string as that of the command for a response.
Space + Parameter	Specifies the value corresponding to the command or response.

Chapter 10

Operation and Control by EtherNet/IP™ Communication

This chapter explains how to operate and control the system via EtherNet/IP™ communication by connecting external devices.

10.1	Introduction to EtherNet/IP™	10-2
10.2	Communications Setup Procedures.....	10-6
10.3	Memory Allocation	10-10
10.4	Timing Chart.....	10-12
10.5	Command List	10-15
10.6	Command Details.....	10-18
10.7	Command Settings.....	10-81



10.1 Introduction to EtherNet/IP™

EtherNet/IP™ is an industrial multi-vendor network that uses Ethernet.

The EtherNet/IP™ specifications are open standards managed by the ODVA (Open DeviceNet Vendor Association). EtherNet/IP™ is used by a wide range of industrial devices.

Because EtherNet/IP™ uses standard Ethernet technology, various general-purpose Ethernet devices can be used in the network.

EtherNet/IP™ has mainly the following features.

■ High-speed, High-capacity Data Exchange through Tag Data Links

The EtherNet/IP™ protocol supports implicit communications, which allows cyclic communications called tag data links with EtherNet/IP™ devices.

■ Tag Data Links at Specified Communications Cycle for Each Application Regardless of the Number of Nodes

Tag data links (cyclic communications) operate at the cyclic period that is specified for each application, regardless of the number of nodes. Data is exchanged over the network at the refresh cycle that is set for each connection. The communications refresh cycle will not increase even if the number of nodes is increased, i.e., the concurrency of the connection's data is maintained.



Precautions for Safe Use

- On a network to which many devices are connected, performance may drop (e.g., responses may be delayed or packets lost) or communications errors may occur when there is temporarily high traffic on the network. Test the operation under actual conditions before you start actual operation of the system.
 - Since a reasonable amount of measurement takt time is required to have stable communications in an operation under high load, verify the operation under the conditions that are to be actually applied.
-

Data Exchange with EtherNet/IP™

■ Communications with Tag Data Links

Data is exchanged cyclically between Ethernet devices on the EtherNet/IP™ network using tag data links as shown below.

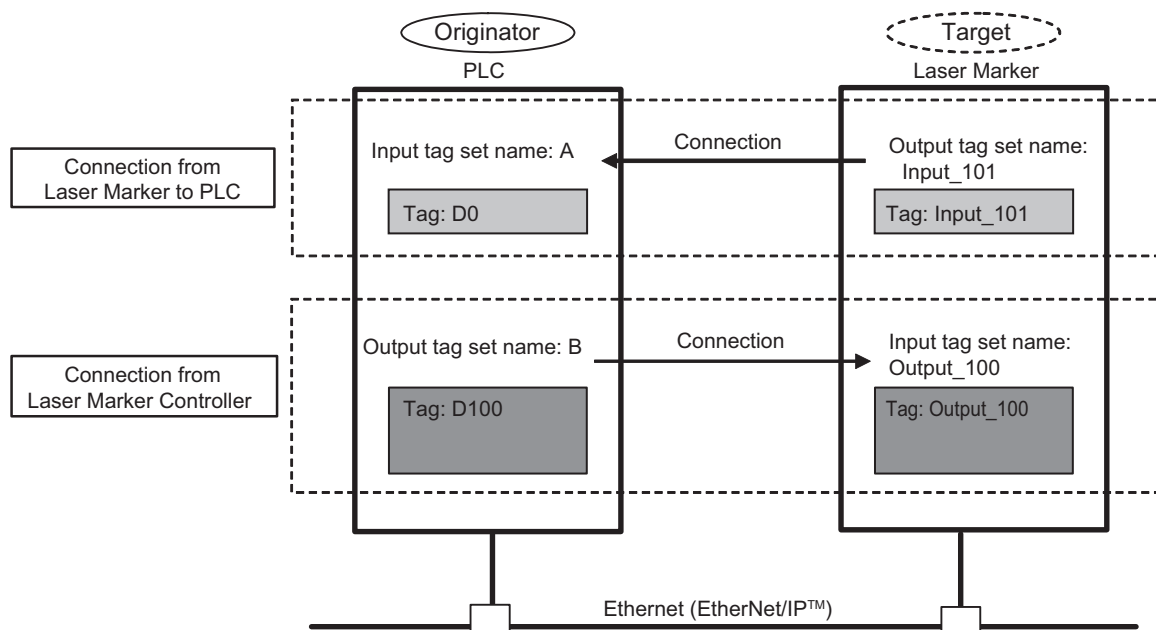

● Data Exchange Method

To exchange data, a connection is opened between two EtherNet/IP™ devices. One of the nodes requests the connection to open a connection with a remote node. The node that requests the connection is called the originator, and the node that receives the request is called the target.

● Data Exchange Memory Locations

The memory locations that are used to exchange data across a connection are specified as tags. You can specify memory addresses or variables for tags. A group of tags consists of an output tag set and an input tag set.

● EtherNet/IP™ communications cycle (RPI)

Tag data link communication via the EtherNet/IP™ is updated according to the packet interval (RPI) communications cycle. Data exchange between an external device such as a PLC and the laser marker is executed at the set RPI.

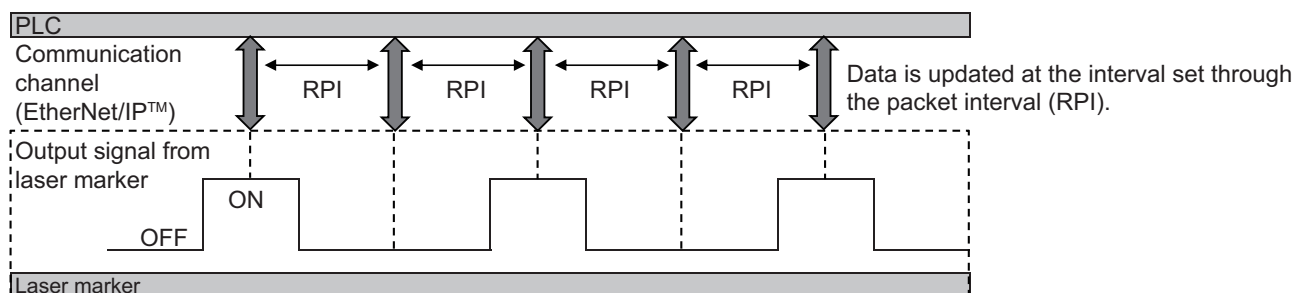

EtherNet/IP™ Communications

You can use an EtherNet/IP™ tag data link to communicate between the PLC and the laser marker to control the laser marker from the PLC with commands/responses or to output data.

Tag data link settings are set using Support Software for tag data link settings.

To connect to OMRON PLC and communicate through EtherNet/IP™, you use the Network Configurator to set up tag data links (i.e., tags, tag sets, and connection settings).

This section describes how to use the Network Configurator to set tag data link settings.



Reference

Refer to the following manuals for details on the tag data link settings that are made with the Network Configurator.

- "NJ-series CPU Unit Built-in EtherNet/IP Port User's Manual" (W506)
 - "EtherNet/IP Units User's Manual" (W465)
 - "CJ-series EtherNet/IP Units User's Manual for NJ-series Connections" (W495)
-



Precautions for Safe Use

- Since a reasonable amount of measurement takt time is required to have stable communications in an operation under high load, verify the operation under the conditions that are to be actually applied.
 - On a network to which many devices are connected, performance may drop (e.g., responses may be delayed or packets lost) or communications errors may occur when there is temporarily high traffic on the network. Test the operation under actual conditions before you start actual operation of the system.
 - The laser marker prioritizes marking processing, marking data generation, and file rewriting time over communication processing. As a result, communication between an external device and the laser marker may be temporarily interrupted, and a communication error may occur. In this case, set the communication error timeout time longer than the laser marker's processing time, or lengthen the measurement interval.
 - If communication is interrupted due to LAN cable is disconnected during tag data link communication of EtherNet/IP™ connection or If communication is interrupted by turning off the power of the laser marker, etc., reset the connection from the PLC.
-

Communications Processing Flow

For EtherNet/IP™ communications, the following two communications areas are set in the PLC to perform communications.

Input tag set to the Laser Marker	(1) Command Area (command/response method)	You write the control commands to execute for the Laser Marker to this area.
Output connection to PLC	(2) Response Area (command/response method)	The Laser Marker writes the results of executing the control commands that were written in the Command Area to this area.

The above two areas are set using Support Software that can set tag data link settings (e.g., SysmacStudio Ver.1.10 or later, Network Configurator). The areas can be specified by using I/O memory addresses or variable names.

For details on tag data link settings using the Network Configurator, refer to  "Tag Data Link Setting Methods (page 10-6)"

Or, if you are connecting to a non-OMRON PLC or EtherNet/IP™ unit, download the EDS file for the Laser Marker from your OMRON website and follow the procedures in the user's manual for the external device you want to connect to and in the instructions for the software that you use to set the tag data link settings.

The flow of EtherNet/IP™ communication between a PLC and the Laser Marker is shown below.

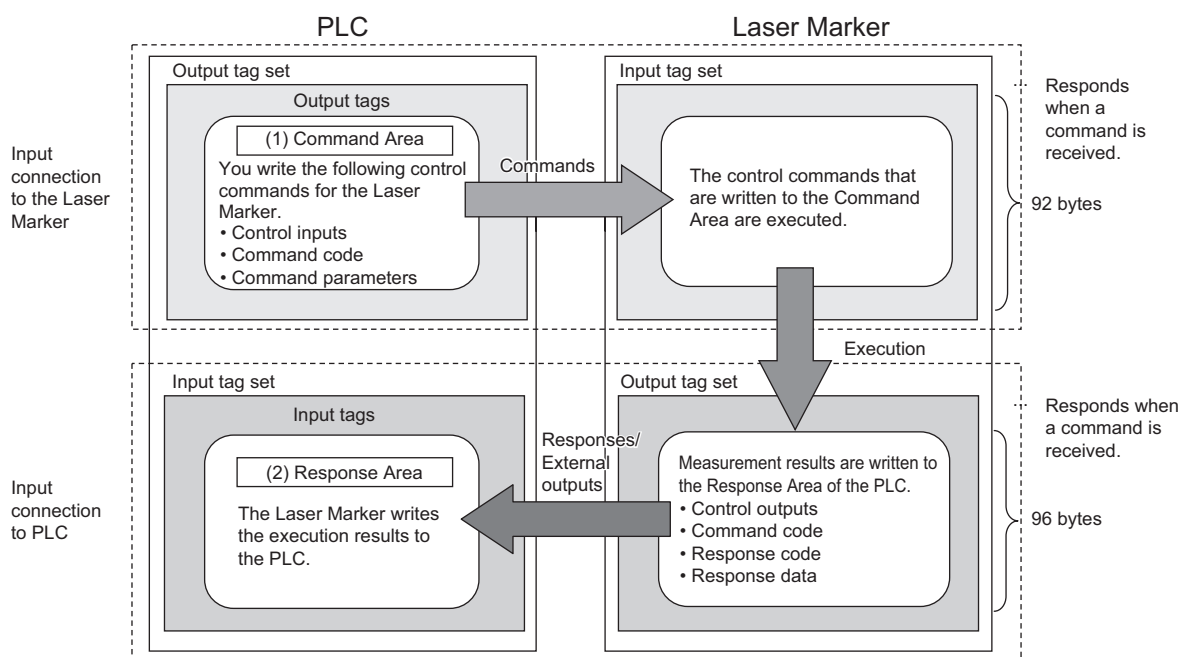

10.2 Communications Setup Procedures

The following settings are required to use EtherNet/IP™ communications.

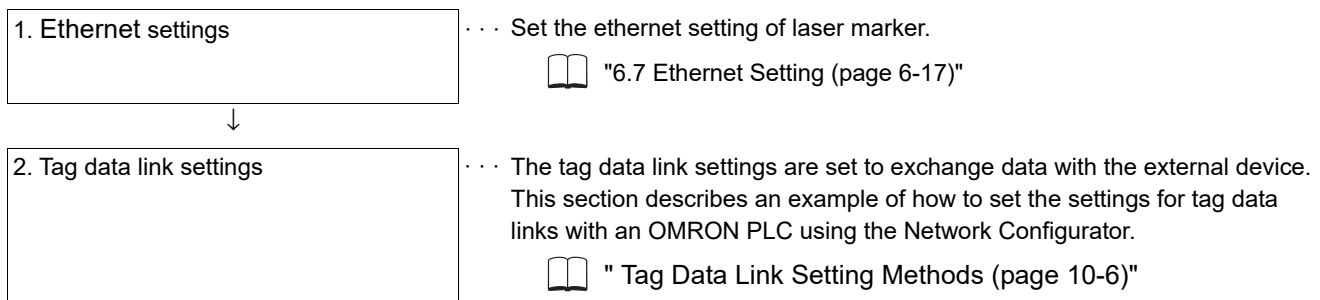

Tag Data Link Setting Methods

This section describes how to set data links for EtherNet/IP™.

The communications areas in the PLC for which data links are created to the Laser Marker are specified as tags and tag sets, and the connections are set for tag data link communications.

To connect to OMRON PLC and communicate through EtherNet/IP™, you use the SysmacStudio Ver.1.10 or later, Network Configurator to set up tag data links (i.e., tags, tag sets, and connection settings).

The procedures to set up the tag data link using the Network Configurator are described here.



Reference

Refer to the following manuals for details on the tag data link settings that are made with the Network Configurator.

- "NJ-series CPU Unit Built-in EtherNet/IP Port User's Manual" (W506)
- "EtherNet/IP Units User's Manual" (W465)
- "CJ-series EtherNet/IP Units User's Manual for NJ-series Connections" (W495)



Precautions for Correct Use

- When connecting to an NJ-series or CJ-series CPU Unit, install the EDS file that defines the connection information for the Laser Marker to the Support Software (e.g., Network Configurator). Download the EDS file from OMRON's website.
- After the tag data links are set, the Vision Sensor is automatically restarted to apply the settings.

■ Tags, Tag Sets, and Connection Settings

The communications areas in the PLC are set as tag data link connections as shown in the following table.

● Tag and Tag Set Settings in the PLC

Parameter	Settings	
	Command Area	Response Area
Tag and tag set description	Output tag set	Input tag set
Tag and tag set names	I/O memory addresses or variable names	I/O memory addresses or variable names ^{*1}
Data size ^{*2}	92/176 byte	96/180 byte

*1 Specify the I/O memory address of the first word in the Response Area. The Output Area is assigned immediately after the Response Area. If you specify a variable name, the variable is assigned for both the Response Area and Output Area.

*2 The data size can be changed to a value that suits the usage application.

MX-Z2000H-V1 Series is set to a combination of 176/180 bytes by default. To continue to use the settings of MX-Z2000H Series, change this to a combination of 92/96 bytes.

If using the MX-Z2000H Series settings, note the total number of parameter channels for the block parameter setting command and block parameter acquisition command ("Block parameter setting (page 10-32)", "Block parameter acquisition (page 10-34)").

Subsequent examples in this manual use a combination of 176/180 bytes for MX-Z2000H-V1 Series.

Data size	Command Area	Response Area
MX-Z2000H Series compatible	92 byte	96 byte
MX-Z2000H-V1 Series default	176 byte	180 byte

● **Settings in the Laser Marker (Device Parameter Settings)**

- 1 Right-click the Laser Marker in the network on the Network Configurator and select [Parameter] – [Edit].
- 2 The Edit Device Parameters Dialog Box will be displayed. Make the required settings.

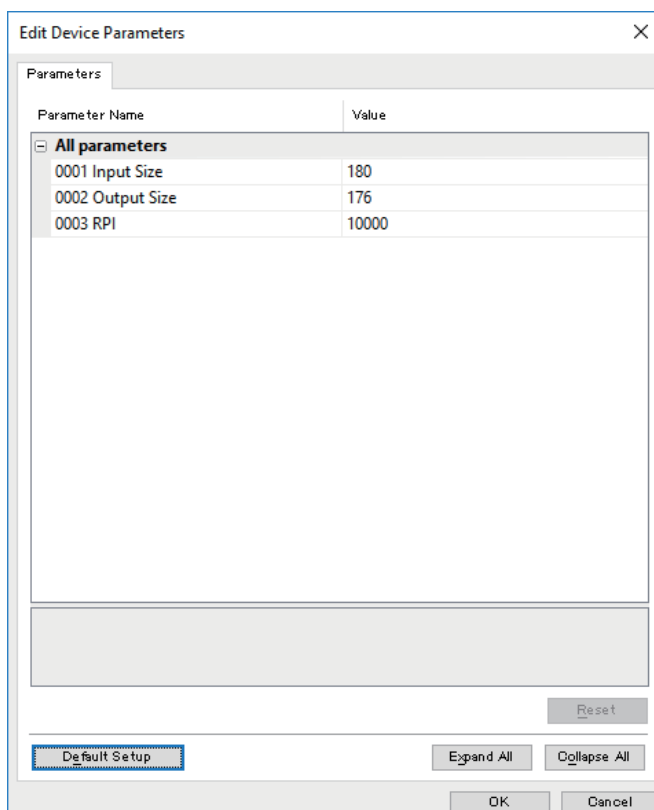

Parameter name	Value	Set value
001 Input Size	Response area size	180 byte
002 Output Size	Command area size.	176 byte
003 RPI	The requested packet interval	10000

*1 Setting of laser marker is set in the connection settings between the PLC and the laser marker. No setting is required here.

● **Connection Settings**

Parameter		Setting
Originator device (PLC)	Input tag set	<i>PLC_tag_set_name</i> -[180 Byte] *1
	Connection type	Any (default: Point to Point connection)
	Output tag set	<i>PLC_tag_set_name</i> -[176 Byte] *1
Target device (Laser Marker)	Output tag set	Input_101-[180 Byte]*1
	Input tag set	Output_100-[176 Byte] *1
Packet interval (RPI)		Any (default: 50.0)
Timeout value		User specified (default: Packet interval (RPI) × 4) Set the timeout interval so that it is longer than the Sensor's measurement processing time.

*1 PLC tags and tag sets need to be same.

**Precautions for Correct Use**

- If I/O memory addresses are specified for the communications areas, the information in the communications areas will be cleared when the operating mode of the PLC changes unless addresses in the CIO Area, which are maintained, are specified.
- The following assembly object is required to specify instances when the EDS file is not used.

Assembly Object Settings

Setting item	Setting	Description	Size
Instance	100	Output connection (for normal control)	Command area
	101	Input connection (for normal control)	Response area
	102	Output connection (for Multi-line)	Command area
	103	Input connection (for Multi-line)	Response area

10.3 Memory Allocation

This section describes the assignments of the Command Area for the input connection to the Sensor and the Response Area and Output Area for the output connection to the PLC.

■ Input Connection to Sensor (PLC Originator to Sensor Controller Target)

For input connections to the laser marker, specify the control input, command code, and command parameters, which are command area parameters.

Command Area

First word in Command Area	Bit																Name
	15	14	13	12	11	10	9	8	7	6	5	4	3	2	1	0	
+0															MKSR	EXE	Control output (2 words)
+1																	
+2	CMD-CODE																Command code (2 words)
+3																	
+4	CMD-PARAM																Command parameters (84 words max.)
+5																	
-																	
-																	
+87																	

Signal	Signal name	Function
EXE	Command Execution Bit	Executes a command.  "10.5 Command List (page 10-15)"
CMD-CODE	Command code	Stores the command code.
CMD-PARAM	Command parameters	Stores command parameters.

MKSR signal

This signal is meant to ensure compatibility with MX-Z2000H Series.

Printing will begin when this signal switches ON. However, the behavior differs from that when the "Start marking" command is using the EXE signal.

For details, refer to "Fiber Laser Marker MX-Z2000H series Setup Manual" (Z376).



Additional Information

If a data size of 92/96 bytes was selected for "6.7 Ethernet Setting (page 6-17)", the total number of parameter channels will be set to 42CH.

■ Output Connection to PLC (Laser Marker Originator to PLC Target)

For output connections to the PLC, execution results and output data from the Laser Marker are set. The execution results (control outputs, command codes, response codes and response data) from the laser marker are output to the response area.

Response Area

First word in Response Area	Bit																Name
	15	14	13	12	11	10	9	8	7	6	5	4	3	2	1	0	
+0	ERR											AND	MK BUSY	MK FLG	BUSY	FLG	Control output (2 words)
+1																	
+2	CMD-CODE																Command code (2 words)
+3																	
+4	RES-CODE																Response code (2 words)
+5																	
+6	RES-DATA																Response data (84 words)
+7																	
-																	
-																	
-																	
+89																	

10

Signal	Signal name	Function
FLG	Command Completion Bit	Turns ON when command execution is completed.
BUSY	Command Busy Bit	Turns ON when command execution is in progress.
MK FLG	Marking Completion Bit	Turns ON when marking is completed.
MK BUSY	Marking Executing Bit	Turns ON when marking is in progress.
AND	Combined Completion Bit	Turns ON when command execution and marking are completed.
ERR	Error Signal	Turns ON when the Sensor Controller detects an error signal from EtherNet/IP™ communication.
CMD-CODE	Command code	Returns the executed command code.
RES-CODE	Response code	Stores the response from the executed command.
RES-DATA	Response data	Stores the response data from the executed command.



Additional Information

If a data size of 92/96 bytes was selected for "6.7 Ethernet Setting (page 6-17)", the total number of response data channels will be set to 42CH.

10.4 Timing Chart

The ON/OFF timing of each signal related to command inputs in processing control command responses are shown in the timing chart.

Command Execution

Various commands including Cancel error that are stored in the memory area of a PLC beforehand are executed using the control command execution (EXE) signal input as a trigger.

After executing a command, turn the control command execution (EXE) signal back to OFF using the control command completion (FLG) ON signal input as a trigger.

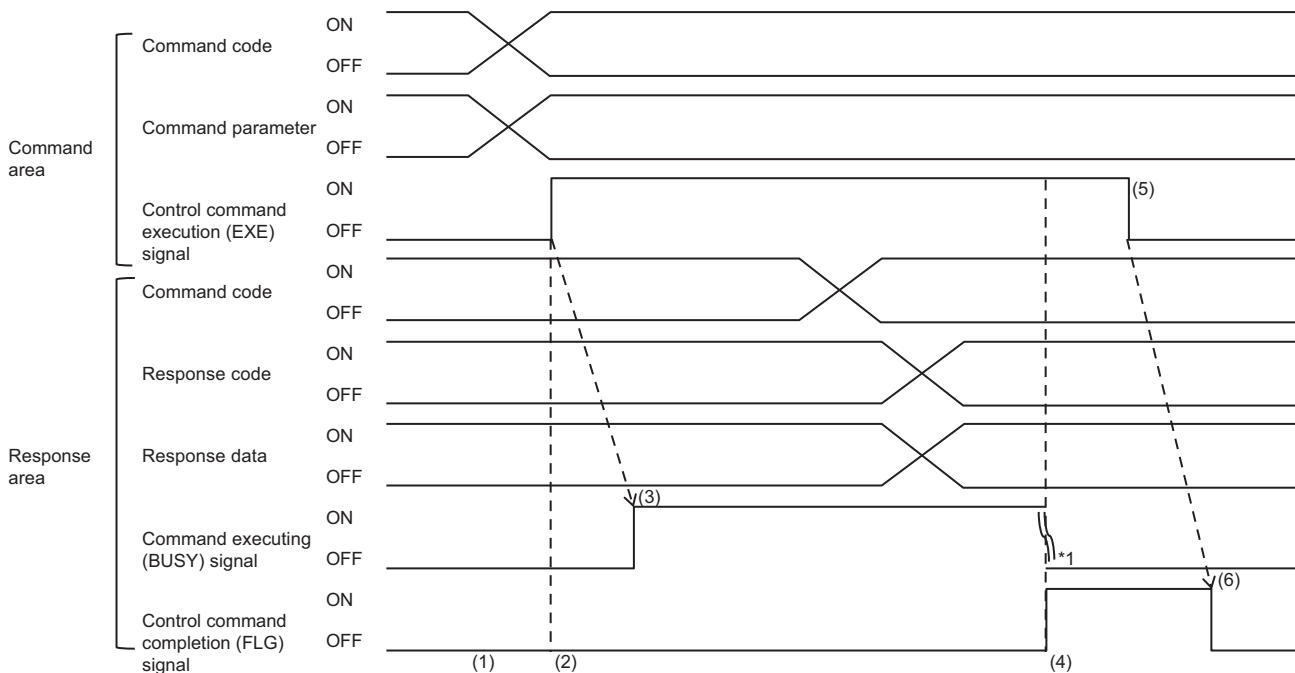

*1 Upon completion of a command execution, the command executing (BUSY) signal automatically switches from ON to OFF.

■ Explanation of operation

- 1 Set the command code and command parameter.**
Set the command code and command parameter from the PLC ((1)).
- 2 Control command (EXE) signal: ON**
Check that the command execution in progress (BUSY) signal and control command completion (FLG) signal are OFF, then switch the control command execution (EXE) signal from OFF to ON ((2)).
An instruction to execute is sent to the laser marker.
- 3 Command executing (BUSY) signal: ON**
When the laser marker receives the instruction to execute, the command executing (BUSY) signal turns ON ((3)) and the command is executed.
- 4 Control command completion (FLG) signal: ON**
When the laser marker has completed the execution, the command code, response code, and response data are set and the control command completion (FLG) turns ON ((4)).

- 5 Control command execution (EXE) signal: OFF**
The PLC turns the control command completion (FLG) signal back to OFF ((5)) under the input condition that the control command completion (FLG) signal is switched from OFF to ON.
- 6 Control command completion (FLG) signal: OFF**
The laser marker confirms that the control command execution (EXE) signal turned OFF and automatically turns OFF the control command completion (FLG) signal ((6)).
If you continue controlling, make sure that the control command completion (FLG) signal is turned OFF, even when controlling from other than EtherNet/IP communication.

Process from marking start to using the marking start command

The "Start marking" command stored in the memory area of a PLC beforehand is input and executed using the control command execution (EXE) signal as a trigger.

After executing marking start, turn the control command execution (EXE) signal back to OFF using the control command completion (FLG) ON signal input as a trigger.

This section shows an example where the control command execution (EXE) signal is turned OFF while marking.

10

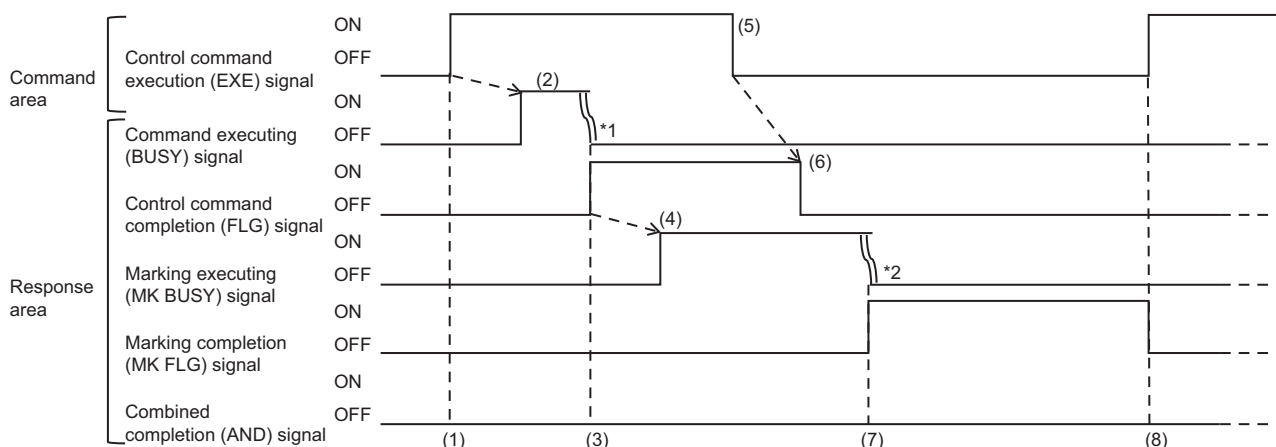

*1 Upon completion of a command execution, the command executing (BUSY) signal automatically switches from ON to OFF.

*2 When the marking is finished, the marking executing (MK BUSY) signal automatically switches from ON to OFF.

■ Explanation of operation

- 1 Control command execution (EXE) signal: ON**
Check that the command execution in progress (BUSY) signal and marking executing (MK BUSY) signal are OFF, then switch the control command (EXE) signal from OFF to ON ((1)).
A marking execution instruction is sent to the laser marker.
- 2 Command executing (BUSY) signal: ON**
When the laser marker receives the marking execution instruction, the command executing (BUSY) signal turns ON ((2)).
- 3 Control command completion (FLG) signal: ON**
When the laser marker has completed the execution, the control command completion (FLG) turns ON ((3)).

- 4 Marking executing (MK BUSY) signal: ON**
When the control command (FLG) turns ON, marking starts and the marking executing (MK BUSY) signal turns ON ((4)).
- 5 Control command execution (EXE) signal: OFF**
The PLC turns the control command (EXE) signal back to OFF ((5)) under the input condition that the control command completion (FLG) signal is switched from OFF to ON.
- 6 Control command completion (FLG) signal: ON**
The laser marker confirms that the control command execution (EXE) signal turned OFF and automatically turns OFF the control command completion (FLG) signal ((6)).
- 7 Marking completion (MK FLG) signal: ON**
The laser marker confirms that marking has been completed and automatically turns ON the marking completion (MK FLG) signal ((7)).
- 8 Control command (EXE) signal: ON**
Once it has been confirmed that the marking completion (MK FLG) signal is ON and the control command (EXE) signal turns back from OFF to ON, the marking completion (MK FLG) signal turns OFF ((8)).
From then on, the same operation is repeated from 2 to 7.



Additional Information

- The marking completion (MK FLG) signal turns from ON to OFF when the control command (EXE) signal turns from OFF to ON.
 - The control command (EXE) signal does not turn OFF after marking is complete. It turns ON when the combined completion (AND) signal command is executed and marking is complete.
-

10.5 Command List

This section explains each command used in EtherNet/IP™.

A command with a description of command area head word can be executed by tag data link communication.

For details on commands used in tag data link communications, refer to  "Command Details (page 10-18)".

- Error processing

First word in Command Area		Command name	Function	Reference page
+3	+2			
0010	1000	Cancel error	Cancels errors and alarms.	10-18
0010	1010	Acquire error	Acquires errors and alarms.	10-19

- Saving marking data

First word in Command Area		Command name	Function	Reference page
+3	+2			
0020	1000	Save edited data	Saves the edited marking data.	10-21

- Editing marking data

First word in Command Area		Command name	Function	Reference page
+3	+2			
0030	1000	Start edit	Starts editing the marking data.	10-21
0030	1010	End edit	Ends editing the marking data.	10-22
0030	1020	Marking parameter setting	Sets the parameter for the marking data (common setting).	10-23
0030	1030	Marking parameter acquisition	Acquires the setting of the parameter for the marking data (common setting).	10-25
0030	2000	Pallet parameter setting	Sets the pallet parameter for the marking data.	10-27
0030	2010	Pallet parameter acquisition	Acquires the setting of the pallet parameter for the marking data.	10-29
0030	3000	Cell parameter setting	Sets the cell parameter for the marking data.	10-30
0030	3010	Cell parameter acquisition	Acquires the setting of the cell parameter for the marking data.	10-31
0030	3020	Block parameter setting	Sets the block parameter for the marking data.	10-32
0030	3030	Block parameter acquisition	Acquires the setting of the block parameter for the marking data.	10-34
0030	4000	Layer parameter setting	Sets the layer parameter for the marking data.	10-36
0030	4010	Layer parameter acquisition	Acquires the setting of the layer parameter for the marking data.	10-38
0030	6000	Specified block string setting	Sets the string of the specified block number.	10-40
0030	6010	Specified block string acquisition	Acquires the string of the specified block number.	10-41
0030	6020	Batch cell marking enabling setting	Enables marking of multiple cells that are specified.	10-43
0030	6030	Batch cell marking disabling setting	Disables marking of multiple cells that are specified.	10-44
-	-	Setting of a block of multiple strings	Sets the marked data for the multiple strings that are specified.	---
0030	7000	Marking content acquisition	Acquires the marking data for which the counter and the link have been converted.	10-46
0030	5000	Block processing parameter setting	Changes processing settings of the specified block.	10-48
0030	5010	Block processing parameter acquisition	Acquires the processing settings of the specified block.	10-49

- Operation

First word in Command Area		Command name	Function	Reference page
+3	+2			
-	-	Marking data list	Acquires the marking data list.	---
0040	7000	Marking data name setting	Sets the file name for the marking data.	10-50
0040	7010	Marking data name acquisition	Acquires the file name for the marking data.	10-52
-	-	Marking data information acquisition	Acquires the marking data information.	---
-	-	Block list	Acquires the block list.	---
0040	9000	Time hold setting	Sets the time hold.	10-53
0040	9010	Time hold status acquisition	Acquires the time hold status.	10-54
0040	1000	Counter setting	Sets the counter.	10-55
0040	1010	Counter setting acquisition	Acquires the counter setting.	10-56
0040	1020	Count up	Counts up the counter.	10-57
0040	1030	Counter reset	Sets the counter to initial value.	10-57
0040	1040	Counter status acquisition	Acquires the counter status.	10-58
0040	1050	Variable data table index specification	Specifies the variable data table No. and index No.	10-59
0040	1060	Variable data table index acquisition	Acquires the variable data table No. and index No.	10-60
0040	2000	Marking data No. specification	Specifies the marking data No.	10-60
0040	2010	Marking data No. acquisition	Acquires the marking data No.	10-61
0040	3000	Position correction value setting	Sets the offset value for position correction.	10-62
0040	3010	Position correction value acquisition	Acquires the offset value for position correction.	10-63
0040	3020	Guide laser setting	Sets the guide laser.	10-64
0040	3030	Guide laser acquisition	Acquires the setting of the guide laser.	10-65
0040	4000	Open the shutter	Opens the shutter.	10-66
0040	4010	Close the shutter	Closes the shutter.	10-66
0040	4020	Device status acquisition	Acquires the device status.	10-67
0040	4030	Marking start	Starts the marking.	10-68
0040	4040	Marking stop	Stops the marking.	10-68
0040	4050	Warm-up start	Starts the warm-up.	10-69
0040	4060	Device information setting	Sets the device information that is displayed in the "Life Counter" function.	10-69
0040	4070	Device information acquisition	Acquires the device information that is displayed in the "Life Counter" function.	10-70
0040	5000	Marking status acquisition	Acquires the device status, including the marking status (MARK BUSY).	10-71
-	-	Drive information acquisition	Acquires the information of the drive connected to the system.	---
-	-	File data transfer	Transfers data between the system and external devices.	---
0040	5040	Backup	Backs up the data in the specified folder.	10-72
0040	5050	Restore	Restores data from the specified folder.	10-72
0040	5010	Power monitor measurement	Acquires the measurement results for the internal power monitor.	10-73
-	-	Reference folder setting	Sets the specified folder as the reference folder.	---
-	-	Reference folder acquisition	Acquires the path for the reference folder.	---
-	-	Marking data deletion	Deletes the specified marking data.	---
-	-	Marker start setting change	Changes the value of the start settings for the marker.	---
-	-	Marker start setting acquisition	Acquires the value of the start settings for the marker.	---
0040	6000	Laser power monitor setting change	Changes the value of the laser monitor setting.	10-74
0040	6010	Laser power monitor setting acquisition	Acquires the value of the laser monitor setting.	10-75
0040	8000	Traceability log setting parameter change	Changes the output setting for the traceability log setting.	10-76
0040	8010	Traceability log setting parameter acquisition	Acquires the output setting for the traceability log setting.	10-77
-	-	Traceability log setting acquisition	Acquires the most updated values that are output to the traceability log setting.	---

- Environment setting and others

First word in Command Area		Command name	Function	Reference page
+3	+2			
-	-	Version acquisition	Acquires the version information.	---
0050	2000	Date/time setting	Sets the date and time.	10-78
0050	2010	Date/time acquisition	Acquires the date and time.	10-79
-	-	Date and time setting with set parameters	Setting date and time according to set parameters.	---
-	-	Call back	Runs the data call back.	---
0050	1000	Power check execution	Runs the laser power check.	10-80

10.6 Command Details

Cancel error

- Command

First word in Command Area	Command code	Bit				Description
		15-12	11-8	7-4	3-0	
+2	1000	0001	0000	0000	0000	Command code
+3	0010	0000	0000	0001	0000	
+4						Command parameter Target 0: Cancel all 1: Cancel error only 2: Cancel alarm only
+5						

- Response

First word in Response Area	Command code	Bit				Description
		15-12	11-8	7-4	3-0	
+2	1000	0001	0000	0000	0000	Command code
+3	0010	0000	0000	0001	0000	Target command code for response
+4	-	0000	0000	0000	0000	Response code
+5	-	0000	0000	0000	0000	Command run result OK: 0 (0000 0000) NG: Other than 0 (0000 0000)

Acquire error



Precautions for Correct Use

Up to 10 errors/alarms can be obtained with this command.

- Command

First word in Command Area	Command code	Bit				Description
		15-12	11-8	7-4	3-0	
+2	1010	0001	0000	0001	0000	Command code
+3	0010	0000	0000	0001	0000	

- Response

First word in Response Area	Command code	Bit				Description
		15-12	11-8	7-4	3-0	
+2	1010	0001	0000	0001	0000	Command code
+3	0010	0000	0000	0001	0000	Target command code for response
+4		0000	0000	0000	0000	Response code
+5		0000	0000	0000	0000	Command run result OK:0(0000 0000) NG: Other than 0 (0000 0000)
+6						Response parameter (when it exists) Error level 1: Alarm 2: Error B 3: Error A
+7						
+8						Error/alarm codes (when it exists)
+9						
+10						Response parameter (when it exists) Error level 1: Alarm 2: Error B 3: Error A
+11						
+12						Error/alarm codes (when it exists)
+13						
+14						Response parameter (when it exists) Error level 1: Alarm 2: Error B 3: Error A
+15						
+16						Error/alarm codes (when it exists)
+17						
+18						Response parameter (when it exists) Error level 1: Alarm 2: Error B 3: Error A
+19						
+20						Error/alarm codes (when it exists)
+21						
+22						Response parameter (when it exists) Error level 1: Alarm 2: Error B 3: Error A
+23						

First word in Response Area	Command code	Bit				Description
		15-12	11-8	7-4	3-0	
+24						Error/alarm codes (when it exists)
+25						
+26						Response parameter (when it exists) Error level 1: Alarm 2: Error B 3: Error A
+27						
+28						Error/alarm codes (when it exists)
+29						
+30						Response parameter (when it exists) Error level 1: Alarm 2: Error B 3: Error A
+31						
+32						Error/alarm codes (when it exists)
+33						
+34						Response parameter (when it exists) Error level 1: Alarm 2: Error B 3: Error A
+35						
+36						Error/alarm codes (when it exists)
+37						
+38						Response parameter (when it exists) Error level 1: Alarm 2: Error B 3: Error A
+39						
+40						Error/alarm codes (when it exists)
+41						
+42						Response parameter (when it exists) Error level 1: Alarm 2: Error B 3: Error A
+43						
+44						Error/alarm codes (when it exists)
+45						

Save edited data

- Command

First word in Command Area	Command code	Bit				Description
		15-12	11-8	7-4	3-0	
+2	1000	0001	0000	0000	0000	Command code
+3	0020	0000	0000	0010	0000	

- Response

First word in Response Area	Command code	Bit				Description
		15-12	11-8	7-4	3-0	
+2	1000	0001	0000	0000	0000	Command code
+3	0020	0000	0000	0010	0000	Target command code for response
+4	-	0000	0000	0000	0000	Response code
+5	-	0000	0000	0000	0000	Command run result OK: 0 (0000 0000) NG: Other than 0 (0000 0000)

10

Start edit

- Command

First word in Command Area	Command code	Bit				Description
		15-12	11-8	7-4	3-0	
+2	1000	0001	0000	0000	0000	Command code
+3	0030	0000	0000	0011	0000	

- Response

First word in Response Area	Command code	Bit				Description
		15-12	11-8	7-4	3-0	
+2	1000	0001	0000	0000	0000	Command code
+3	0030	0000	0000	0011	0000	Target command code for response
+4	-	0000	0000	0000	0000	Response code
+5	-	0000	0000	0000	0000	Command run result OK: 0 (0000 0000) NG: Other than 0 (0000 0000)

End edit

- Command

First word in Command Area	Command code	Bit				Description
		15-12	11-8	7-4	3-0	
+2	1010	0001	0000	0001	0000	Command code
+3	0030	0000	0000	0011	0000	

- Response

First word in Response Area	Command code	Bit				Description
		15-12	11-8	7-4	3-0	
+2	1010	0001	0000	0001	0000	Command code
+3	0030	0000	0000	0011	0000	Target command code for response
+4	-	0000	0000	0000	0000	Response code
+5	-	0000	0000	0000	0000	Command run result OK: 0 (0000 0000) NG: Other than 0 (0000 0000)

Marking parameter setting

- Command

First word in Command Area	Command code	Bit				Description
		15-12	11-8	7-4	3-0	
+2	1020	0001	0000	0010	0000	Command code
+3	0030	0000	0000	0011	0000	
+4						Continuous count 0 to 65535 Unit: count Note: 0 indicates infinite marking
+5						
+6						Interval 0 to 60000 Unit: ms
+7						
+8						Interval setting method 0: Start - Start 1: End - Start
+9						
+10						End signal in continuation 0: None 1: ON
+11						
+12						Marking method 0: Left 1: Right 2: Up 3: Down Note: The baseline is the upper side of the characters.
+13						
+14						Mirror flip 0: None 1: Left/right 2: Up/down 3: Up/down/left/right
+15						
+16						Optimization 0: None 1: Speed
+17						
+18						Optimization time 0 to 600 Unit: 1/10s
+19						
+20						X correction MX-Z2000H-V1: -45000 to 45000 MX-Z2050H-V1/Z2055H-V1: -80000 to 80000 Unit: 1/1000mm
+21						
+22						Y correction MX-Z2000H-V1: -45000 to 45000 MX-Z2050H-V1/Z2055H-V1: -80000 to 80000 Unit: 1/1000mm
+23						
+24						Z correction -10000 to 10000 Unit: 1/1000mm
+25						
+26						θZ correction -4500 to 4500 Unit: 1/100°
+27						
+28						Trigger delay 0 to 10000 Unit: ms
+29						

First word in Command Area	Command code	Bit				Description
		15-12	11-8	7-4	3-0	
+30						Power 1 to 100 Unit: %
+31						
+32						Frequency 10 to 1000 (Standard mode) 10 to 100 (EE mode) Unit: kHz
+33						
+34						Pulse shape 1 to 15 (Standard mode) 1 to 3 (EE mode)
+35						
+36						Processing speed 1 to 12000 Unit: mm/s
+37						

• Response

First word in Response Area	Command code	Bit				Description
		15-12	11-8	7-4	3-0	
+2	1020	0001	0000	0000	0000	Command code Target command code for response
+3	0030	0000	0000	0010	0000	
+4		0000	0000	0000	0000	Response code Command run result OK: 0 (0000 0000) NG: Other than 0 (0000 0000)
+5		0000	0000	0000	0000	

Marking parameter acquisition

- Command

First word in Command Area	Command code	Bit				Description
		15-12	11-8	7-4	3-0	
+2	1030	0001	0000	0011	0000	Command code
+3	0030	0000	0000	0011	0000	

- Response

First word in Response Area	Command code	Bit				Description
		15-12	11-8	7-4	3-0	
+2	1030	0001	0000	0011	0000	Command code
+3	0030	0000	0000	0011	0000	Target command code for response
+4		0000	0000	0000	0000	Response code
+5		0000	0000	0000	0000	Command run result OK: 0 (0000 0000) NG: Other than 0 (0000 0000)
+6						Continuous count
+7						Unit: count
+8						Interval
+9						Unit: ms
+10						Interval setting method
+11						0: Start - Start 1: End - Start
+12						End signal in continuation
+13						0: None 1: ON
+14						Marking method
+15						0: Left 1: Right 2: Up 3: Down Note: The baseline is the upper side of the characters.
+16						Mirror flip
+17						0: None 1: Left/right 2: Up/down 3: Up/down/left/right
+18						Optimization
+19						0: None 1: Speed
+20						Optimization time
+21						Unit: 1/10s
+22						X correction
+23						Unit: 1/1000mm
+24						Y correction
+25						Unit: 1/1000mm
+26						Z correction
+27						Unit: 1/1000mm
+28						θZ correction
+29						Unit: 1/100°
+30						Trigger delay
+31						Unit: ms

First word in Response Area	Command code	Bit				Description
		15-12	11-8	7-4	3-0	
+32						Power Unit: %
+33						
+34						Frequency Unit: kHz
+35						
+36						Pulse shape Pattern No.
+37						
+38						Processing speed Unit: mm/s
+39						

Pallet parameter setting

- Command

First word in Command Area	Command code	Bit				Description
		15-12	11-8	7-4	3-0	
+2	2000	0010	0000	0000	0000	Command code
+3	0030	0000	0000	0011	0000	
+4						Command parameter Pallet specification 0: Disabled 1: Enabled
+5						
+6						Clipping position start point X Type MX-Z2000H-V1: -45000 to 45000 Type MX-Z2050H-V1/Z2055H-V1: -80000 to 80000 Unit: 1/1000 mm
+7						
+8						Clipping position start point Y Type MX-Z2000H-V1: -45000 to 45000 Type MX-Z2050H-V1/Z2055H-V1: -80000 to 80000 Unit: 1/1000 mm
+9						
+10						Clipping width Type MX-Z2000H-V1: 1 to 90000 Type MX-Z2050H-V1/Z2055H-V1: 1 to 160000 Unit: 1/1000 mm
+11						
+12						Clipping height Type MX-Z2000H-V1: 1 to 90000 Type MX-Z2050H-V1/Z2055H-V1: 1 to 160000 Unit: 1/1000 mm
+13						
+14						Clipping rotation angle -4500 to 4500 Unit: 1/100°
+15						
+16						First position start point X Type MX-Z2000H-V1: -45000 to 45000 Type MX-Z2050H-V1/Z2055H-V1: -80000 to 80000 Unit: 1/1000 mm
+17						
+18						First position start point Y Type MX-Z2000H-V1: -45000 to 45000 Type MX-Z2050H-V1/Z2055H-V1: -80000 to 80000 Unit: 1/1000 mm
+19						
+20						Interval X Type MX-Z2000H-V1: 0 to 90000 Type MX-Z2050H-V1/Z2055H-V1: 0 to 160000 Unit: 1/1000 mm
+21						
+22						Interval Y Type MX-Z2000H-V1: 0 to 90000 Type MX-Z2050H-V1/Z2055H-V1: 0 to 160000 Unit: 1/1000 mm
+23						

First word in Command Area	Command code	Bit				Description
		15-12	11-8	7-4	3-0	
+24						Number of cells X 1 to 255
+25						
+26						Number of cells Y 1 to 255
+27						
+28						Cell count-up direction 0: Lateral direction from upper left 1: Lateral direction from upper right 2: Lateral direction from down left 3: Lateral direction from down right 4: Vertical direction from upper left 5: Vertical direction from upper right 6: Vertical direction from down left 7: Vertical direction from down right
+29						
+30						Non-marking cells 0: Do not count up 1: Count up
+31						

• Response

First word in Response Area	Command code	Bit				Description
		15-12	11-8	7-4	3-0	
+2	2000	0010	0000	0000	0000	Command code
+3	0030	0000	0000	0011	0000	Target command code for response
+4	-	0000	0000	0000	0000	Response code
+5	-	0000	0000	0000	0000	Command run result OK: 0 (0000 0000) NG: Other than 0 (0000 0000)

Pallet parameter acquisition

- Command

First word in Command Area	Command code	Bit				Description
		15-12	11-8	7-4	3-0	
+2	2010	0010	0000	0001	0000	Command code
+3	0030	0000	0000	0011	0000	

- Response

First word in Response Area	Command code	Bit				Description
		15-12	11-8	7-4	3-0	
+2	2010	0010	0000	0001	0000	Command code
+3	0030	0000	0000	0011	0000	Target command code for response
+4	-	0000	0000	0000	0000	Response code
+5	-	0000	0000	0000	0000	Command run result OK: 0(0000 0000) NG: Other than 0(0000 0000)
+6						Command parameter Pallet specification 0: Disabled 1: Enabled
+7						
+8						Clipping position start point X Unit: 1/1000 mm
+9						
+10						Clipping position start point Y Unit: 1/1000 mm
+11						
+12						Clipping width Unit: 1/1000 mm
+13						
+14						Clipping height Unit: 1/1000 mm
+15						
+16						Clipping rotation angle Unit: 1/100°
+17						
+18						First position start point X Unit: 1/1000 mm
+19						
+20						First position start point Y Unit: 1/1000 mm
+21						
+22						Interval X Unit: 1/1000 mm
+23						
+24						Interval Y Unit: 1/1000 mm
+25						
+26						Number of cells X 1 to 255
+27						
+28						Number of cells Y 1 to 255
+29						
+30						Cell count-up direction 0: Lateral direction from upper left 1: Lateral direction from upper right 2: Lateral direction from down left 3: Lateral direction from down right 4: Vertical direction from upper left 5: Vertical direction from upper right 6: Vertical direction from down left 7: Vertical direction from down right
+31						
+32						Non-marking cells 0: Do not count up 1: Count up
+33						

Cell parameter setting

- Command

First word in Command Area	Command code	Bit				Description
		15-12	11-8	7-4	3-0	
+2	3000	0011	0000	0000	0000	Command code
+3	0030	0000	0000	0011	0000	
+4						Command parameter Cell position X 0 to 254
+5						
+6						Cell position Y 0 to 254
+7						
+8						Marking target 0: No 1: Yes
+9						
+10						Enable count-up 0: Disabled 1: Enabled
+11						
+12						X correction Type MX-Z2000H-V1: -45000 to 45000 Type MX-Z2050H-V1/Z2055H-V1: -80000 to 80000 Unit: 1/1000 mm
+13						
+14						Y correction Type MX-Z2000H-V1: -45000 to 45000 Type MX-Z2050H-V1/Z2055H-V1: -80000 to 80000 Unit: 1/1000 mm
+15						
+16						Z correction -10000 to 10000 Unit: 1/1000 mm
+17						
+18						θZ correction -18000 to 18000 Unit: 1/100°
+19						

- Response

First word in Response Area	Command code	Bit				Description
		15-12	11-8	7-4	3-0	
+2	3000	0011	0000	0000	0000	Command code
+3	0030	0000	0000	0011	0000	Target command code for response
+4	-	0000	0000	0000	0000	Response code
+5	-	0000	0000	0000	0000	Command run result OK: 0(0000 0000) NG: Other than 0(0000 0000)

Cell parameter acquisition

- Command

First word in Command Area	Command code	Bit				Description
		15-12	11-8	7-4	3-0	
+2	3010	0011	0000	0001	0000	Command code
+3	0030	0000	0000	0011	0000	
+4						Command parameter Cell position X 0 to 254
+5						
+6						Cell position Y 0 to 254
+7						

- Response

First word in Response Area	Command code	Bit				Description
		15-12	11-8	7-4	3-0	
+2	3010	0011	0000	0001	0000	Command code
+3	0030	0000	0000	0011	0000	Target command code for response
+4	-	0000	0000	0000	0000	Response code
+5	-	0000	0000	0000	0000	Command run result OK: 0(0000 0000) NG: Other than 0(0000 0000)
+6						Response parameter Marking target 0: No 1: Yes
+7						
+8						Enable count-up 0: Disabled 1: Enabled
+9						
+10						X correction Unit: 1/1000 mm
+11						
+12						Y correction Unit: 1/1000 mm
+13						
+14						Z correction Unit: 1/1000 mm
+15						
+16						θZ correction Unit: 1/100°
+17						

Block parameter setting



Precautions for Correct Use

- If a data size of 92/96 bytes was selected for "6.7 Ethernet Setting (page 6-17)", this command can be used to set up to the 28th character for block content.
- **When changing the block contents with this command**
The marking position and shape may differ between software Ver4.1.x or later and software Ver4.0.x or earlier. Please check the marking content in advance.

- Command

First word in Command Area	Command code	Bit				Description
		15-12	11-8	7-4	3-0	
+2	3020	0011	0000	0010	0000	Command code
+3	0030	0000	0000	0011	0000	
+4						Block No. 0 to 2047
+5						
+6						Marking target 0: No 1: Yes
+7						
+8						Coordinate X MX-Z2000H-V1: -90000 to 90000 MX-Z2050H-V1/Z2055H-V1: -160000 to 160000 Unit: 1/1000mm
+9						
+10						Coordinate Y MX-Z2000H-V1: -90000 to 90000 MX-Z2050H-V1/Z2055H-V1: -160000 to 160000 Unit: 1/1000mm
+11						
+12						Rotation angle 0 to 35999 1/100°
+13						
+14						Total width MX-Z2000H-V1: 1 to 90000 MX-Z2050H-V1/Z2055H-V1: 1 to 160000 Unit: 1/1000mm
+15						
+16						Total height MX-Z2000H-V1:1 to 90000 MX-Z2050H-V1/Z2055H-V1: 1 to 160000 Unit: 1/1000mm
+17						
+18						Block content 1st character
+19						2nd character
+20						3rd character
+21						4th character
+22						5th character
+23						6th character
+24						7th character
+25						8th character
+26						9th character

First word in Command Area	Command code	Bit				Description
		15-12	11-8	7-4	3-0	
+27						10th character
+28						11st character
+29						12nd character
+30						13th character
+31						14th character
+32						15th character
+33						16th character
+34						17th character
+35						18th character
+36						19th character
+37						20th character
+38						21st character
+39						22nd character
+40						23rd character
+41						24th character
+42						25th character
+43						26th character
+44						27th character
+45						28th character
+46						29th character
+47						30th character
+48						31st character
+49						32nd character
+50						33rd character
+51						34th character
+52						35th character
+53						36th character
+54						37th character
+55						38th character
+56						39th character
+57						40th character

- Response

First word in Response Area	Command code	Bit				Description
		15-12	11-8	7-4	3-0	
+2	3020	0011	0000	0010	0000	Command code
+3	0030	0000	0000	0011	0000	Target command code for response
+4		0000	0000	0000	0000	Response code
+5		0000	0000	0000	0000	Command run result OK: 0 (0000 0000) NG: Other than 0 (0000 0000)

Block parameter acquisition



Precautions for Correct Use

If a data size of 92/96 bytes was selected for "6.7 Ethernet Setting (page 6-17)", this command can be used to acquire up to the 30th character for block content.

- Command

First word in Command Area	Command code	Bit				Description
		15-12	11-8	7-4	3-0	
+2	3030	0011	0000	0011	0000	Command code
+3	0030	0000	0000	0011	0000	
+4						Block No. 0 to 2047
+5						

- Response

First word in Response Area	Command code	Bit				Description
		15-12	11-8	7-4	3-0	
+2	3030	0011	0000	0011	0000	Command code
+3	0030	0000	0000	0011	0000	Target command code for response
+4		0000	0000	0000	0000	Response code
+5		0000	0000	0000	0000	Command run result OK: 0 (0000 0000) NG: Other than 0 (0000 0000)
+6						Marking target 0: No 1: Yes
+7						
+8						Coordinate X Unit: 1/1000mm
+9						
+10						Coordinate Y Unit: 1/1000mm
+11						
+12						Rotation angle 1/100°
+13						
+14						Total width*1 Unit: 1/1000mm
+15						
+16						Total height*2 Unit: 1/1000mm
+17						
+18						Block content 1st character
+19						2nd character
+20						3rd character
+21						4th character
+22						5th character
+23						6th character
+24						7th character
+25						8th character
+26						9th character
+27						10th character
+28						11st character
+29						12nd character
+30						13th character
+31						14th character
+32						15th character

First word in Response Area	Command code	Bit				Description
		15-12	11-8	7-4	3-0	
+33						16th character
+34						17th character
+35						18th character
+36						19th character
+37						20th character
+38						21st character
+39						22nd character
+40						23rd character
+41						24th character
+42						25th character
+43						26th character
+44						27th character
+45						28th character
+46						29th character
+47						30th character
+48						31st character
+49						32nd character
+50						33rd character
+51						34th character
+52						35th character
+53						36th character
+54						37th character
+55						38th character
+56						39th character
+57						40th character

*1 When the block type is "Fixed point", parameters are not returned.

*2 When the block type is "Line", "Rectangle", "Circle", or "Arc", parameters are not returned.

Layer parameter setting

- Command

First word in Command Area	Command code	Bit				Description
		15-12	11-8	7-4	3-0	
+2	4000	0100	0000	0000	0000	Command code
+3	0030	0000	0000	0011	0000	
+4						Command parameter Layer No. 0 to 7
+5						
+6						Layer setting 0: Horizontal surface 1: Column external (X axis direction) 2: Column external (Y axis direction) 3: Column internal (X axis direction) 4: Column internal (Y axis direction) 5: Cone external (X axis right vertex) 6: Cone external (X axis left vertex) 7: Cone external (Y axis top vertex) 8: Cone external (Y axis bottom vertex) 9: Cone external (Z axis vertex) 10: Cone internal (X axis right vertex) 11: Cone internal (X axis left vertex) 12: Cone internal (Y axis top vertex) 13: Cone internal (Y axis bottom vertex) 14: Cone internal (Z axis vertex) 15: Sphere external 16: Sphere internal
+7						
+8						X axis correction Type MX-Z2000H-V1: -45000 to 45000 Type MX-Z2050H-V1/Z2055H-V1: -80000 to 80000 Unit: 1/1000 mm
+9						
+10						Y axis correction Type MX-Z2000H-V1: -45000 to 45000 Type MX-Z2050H-V1/Z2055H-V1: -80000 to 80000 Unit: 1/1000 mm
+11						
+12						Z axis correction -10000 to 10000 Unit: 1/1000 mm
+13						
+14						θX correction -9000 to 9000 Unit: 1/100°
+15						
+16						θY correction -9000 to 9000 Unit: 1/100°
+17						
+18						θZ correction -4500 to 4500 Unit: 1/100°
+19						
+20						Radius 1 to 999999 Unit: 1/1000 mm
+21						
+22						Surface division count 4 to 50
+23						

First word in Command Area	Command code	Bit				Description
		15-12	11-8	7-4	3-0	
+24						Height 1 to 999999 Unit: 1/1000 mm
+25						
+26						Large circle radius 1 to 999999 Unit: 1/1000 mm
+27						
+28						Small circle radius 1 to 999999 Unit: 1/1000 mm
+29						
+30						Cone placement 0: Placed directly 1: Marking surface horizontal 2: Semi-cone
+31						
+32						Lower circle radius 1 to 999999 Unit: 1/1000 mm
+33						
+34						Upper circle radius 1 to 999999 Unit: 1/1000 mm
+35						
+36						Horizontal division count 4 to 20
+37						
+38						Vertical division count 4 to 20
+39						
+40						X radius 1 to 999999 Unit: 1/1000 mm
+41						
+42						Y radius 1 to 999999 Unit: 1/1000 mm
+43						
+44						Z radius 1 to 999999 Unit: 1/1000 mm
+45						

- Response

First word in Response Area	Command code	Bit				Description
		15-12	11-8	7-4	3-0	
+2	4000	0100	0000	0000	0000	Command code Target command code for response
+3	0030	0000	0000	0011	0000	
+4	-	0000	0000	0000	0000	Response code
+5	-	0000	0000	0000	0000	Command run result OK: 0 (0000 0000) NG: Other than 0 (0000 0000)

Layer parameter acquisition

• Command

First word in Command Area	Command code	Bit				Description
		15-12	11-8	7-4	3-0	
+2	4010	0100	0000	0001	0000	Command code
+3	0030	0000	0000	0011	0000	
+4						Command parameter Layer No. 0 to 7

• Response

First word in Response Area	Command code	Bit				Description	
		15-12	11-8	7-4	3-0		
+2	4010	0100	0000	0001	0000	Command code	
+3	0030	0000	0000	0011	0000	Target command code for response	
+4	-	0000	0000	0000	0000	Response code Command run result	
+5	-	0000	0000	0000	0000	OK: 0(0000 0000) NG: Other than 0(0000 0000)	
+6						Response parameter Layer No. 0 to 7	
+7							
+8						Layer setting 0: Horizontal surface 1: Column external (X axis direction) 2: Column external (Y axis direction) 3: Column internal (X axis direction) 4: Column internal (Y axis direction) 5: Cone external (X axis right vertex) 6: Cone external (X axis left vertex) 7: Cone external (Y axis top vertex) 8: Cone external (Y axis bottom vertex) 9: Cone external (Z axis vertex) 10: Cone internal (X axis right vertex) 11: Cone internal (X axis left vertex) 12: Cone internal (Y axis top vertex) 13: Cone internal (Y axis bottom vertex) 14: Cone internal (Z axis vertex) 15: Sphere external 16: Sphere internal	
+9							
+10							X axis correction variable Unit: 1/1000 mm
+11							
+12							Y axis correction variable Unit: 1/1000 mm
+13							
+14							Z axis correction Unit: 1/1000 mm
+15							
+16							θX correction Unit: 1/100°
+17							
+18							θY correction Unit: 1/100°
+19							
+20							θZ correction Unit: 1/100°
+21							

First word in Response Area	Command code	Bit				Description
		15-12	11-8	7-4	3-0	
+22						Radius Unit: 1/1000 mm
+23						
+24						Surface division count 4 to 50
+25						
+26						Height Unit: 1/1000 mm
+27						
+28						Large circle radius Unit: 1/1000 mm
+29						
+30						Small circle radius Unit: 1/1000 mm
+31						
+32						Cone placement 0: Placed directly 1: Marking surface horizontal 2: Semi-cone
+33						
+34						Lower circle radius Unit: 1/1000 mm
+35						
+36						Upper circle radius Unit: 1/1000 mm
+37						
+38						Horizontal division count 4 to 50
+39						
+40						Vertical division count 4 to 50
+41						
+42						X radius Unit: 1/1000 mm
+43						
+44						Y radius Unit: 1/1000 mm
+45						
+46						Z radius Unit: 1/1000 mm
+47						

Specified block string setting

**Precautions for Correct Use**

This command can open marking data names of 40 characters or less. Only ASCII or Shift-JIS character codes can be set with this command.

To set the character code to ASCII, set the lower 8 bits.

If only the upper 8 bits are set, they are considered to be the end of the character string.

When 0 (0000 0000) is set in channel 1, it is considered to be the end of the character string.

• Command

First word in Command Area	Command code	Bit				Description
		15-12	11-8	7-4	3-0	
+2	6000	0110	0000	0000	0000	Command code
+3	0030	0000	0000	0011	0000	
+4						Command parameter Block number (0 to 2047)
+5						
+6						1st character
+7						2nd character
+8						3rd character
+9						4th character
+10						5th character
+11						6th character
+12						7th character
+13						8th character
+14						9th character
+15						10th character
+16						11st character
+17						12nd character
+18						13th character
+19						14th character
+20						15th character
+21						16th character
+22						17th character
+23						18th character
+24						19th character
+25						20th character
+26						21st character
+27						22nd character
+28						23rd character
+29						24th character
+30						25th character
+31						26th character
+32						27th character
+33						28th character
+34						29th character
+35						30th character
+36						31st character
+37						32nd character
+38						33rd character
+39						34th character
+40						35th character
+41						36th character
+42						37th character
+43						38th character

First word in Command Area	Command code	Bit				Description
		15-12	11-8	7-4	3-0	
+44						39th character
+45						40th character

- Response

First word in Response Area	Command code	Bit				Description
		15-12	11-8	7-4	3-0	
+2	6000	0110	0000	0000	0000	Command code
+3	0030	0000	0000	0011	0000	Target command code for response
+4		0000	0000	0000	0000	Response code
+5		0000	0000	0000	0000	Command run result OK:0(0000 0000) NG:0(0000 0000)

Specified block string acquisition



Precautions for Correct Use

Up to 40 characters can be set with this command.

Only ASCII or S-JIS character codes can be set with this command.

- Command

First word in Command Area	Command code	Bit				Description
		15-12	11-8	7-4	3-0	
+2	6010	0110	0000	0001	0000	Command code
+3	0030	0000	0000	0011	0000	
+4						Response parameter
+5						Block number (0 to 2047)

- Response

First word in Response Area	Command code	Bit				Description
		15-12	11-8	7-4	3-0	
+2	6010	0110	0000	0001	0000	Command code
+3	0030	0000	0000	0011	0000	Target command code for response
+4		0000	0000	0000	0000	Response code
+5		0000	0000	0000	0000	Command run result OK:0(0000 0000) NG:0(0000 0000)
+6						1st character
+7						2nd character
+8						3rd character
+9						4th character
+10						5th character
+11						6th character
+12						7th character
+13						8th character

First word in Response Area	Command code	Bit				Description
		15-12	11-8	7-4	3-0	
+14						9th character
+15						10th character
+16						11st character
+17						12nd character
+18						13th character
+19						14th character
+20						15th character
+21						16th character
+22						17th character
+23						18th character
+24						19th character
+25						20th character
+26						21st character
+27						22nd character
+28						23rd character
+29						24th character
+30						25th character
+31						26th character
+32						27th character
+33						28th character
+34						29th character
+35						30th character
+36						31st character
+37						32nd character
+38						33rd character
+39						34th character
+40						35th character
+41						36th character
+42						37th character
+43						38th character
+44						39th character
+45						40th character

Batch cell marking enabling setting

- Command

First word in Command Area	Command code	Bit				Description
		15-12	11-8	7-4	3-0	
+2	6020	0110	0000	0010	0000	Command code
+3	0030	0000	0000	0011	0000	
+4						Number of enabled cells 1 to 18
+5						
+6						Cell number Cell numbers to be enabled (1st)
+7						
+8						Cell number Cell numbers to be enabled (2nd)
+9						
+10						Cell number Cell numbers to be enabled (3rd)
+11						
+12						Cell number Cell numbers to be enabled (4th)
+13						
+14						Cell number Cell numbers to be enabled (5th)
+15						
+16						Cell number Cell numbers to be enabled (6th)
+17						
+18						Cell number Cell numbers to be enabled (7th)
+19						
+20						Cell number Cell numbers to be enabled (8th)
+21						
+22						Cell number Cell numbers to be enabled (9th)
+23						
+24						Cell number Cell numbers to be enabled (10th)
+25						
+26						Cell number Cell numbers to be enabled (11st)
+27						
+28						Cell number Cell numbers to be enabled (12nd)
+29						
+30						Cell number Cell numbers to be enabled (13th)
+31						
+32						Cell number Cell numbers to be enabled (14th)
+33						
+34						Cell number Cell numbers to be enabled (15th)
+35						
+36						Cell number Cell numbers to be enabled (16th)
+37						
+38						Cell number Cell numbers to be enabled (17th)
+39						
+40						Cell number Cell numbers to be enabled (18th)
+41						

- Response

First word in Response Area	Command code	Bit				Description
		15-12	11-8	7-4	3-0	
+2	6020	0110	0000	0010	0000	Command code Target command code for response
+3	0030	0000	0000	0011	0000	

First word in Response Area	Command code	Bit				Description
		15-12	11-8	7-4	3-0	
+4		0000	0000	0000	0000	Response code
+5		0000	0000	0000	0000	Command run result OK: 0 (0000 0000) NG: Other than 0 (0000 0000)

Batch cell marking disabling setting

- Command

First word in Command Area	Command code	Bit				Description
		15-12	11-8	7-4	3-0	
+2	6030	0110	0000	0011	0000	Command code
+3	0030	0000	0000	0011	0000	
+4						Number of disabled cells 1 to 18
+5						
+6						Cell number Cell number to be disabled (1st)
+7						
+8						Cell number Cell number to be disabled (2nd)
+9						
+10						Cell number Cell number to be disabled (3rd)
+11						
+12						Cell number Cell number to be disabled (4th)
+13						
+14						Cell number Cell number to be disabled (5th)
+15						
+16						Cell number Cell number to be disabled (6th)
+17						
+18						Cell number Cell number to be disabled (7th)
+19						
+20						Cell number Cell number to be disabled (8th)
+21						
+22						Cell number Cell number to be disabled (9th)
+23						
+24						Cell number Cell number to be disabled (10th)
+25						
+26						Cell number Cell number to be disabled (11st)
+27						
+28						Cell number Cell number to be disabled (12nd)
+29						
+30						Cell number Cell number to be disabled (13th)
+31						
+32						Cell number Cell number to be disabled (14th)
+33						
+34						Cell number Cell number to be disabled (15th)
+35						
+36						Cell number Cell number to be disabled (16th)
+37						
+38						Cell number Cell number to be disabled (17th)
+39						
+40						Cell number Cell number to be disabled (18th)
+41						

- Response

First word in Response Area	Command code	Bit				Description
		15-12	11-8	7-4	3-0	
+2	6030	0110	0000	0011	0000	Command code
+3	0030	0000	0000	0011	0000	Target command code for response
+4		0000	0000	0000	0000	Response code
+5		0000	0000	0000	0000	Command run result OK: 0 (0000 0000) NG: Other than 0 (0000 0000)

Marking content acquisition



Precautions for Correct Use

Up to 40 characters can be set with this command.
Only ASCII or S-JIS character codes can be set with this command.

- Command

First word in Command Area	Command code	Bit				Description
		15-12	11-8	7-4	3-0	
+2	7000	0111	0000	0000	0000	Command code
+3	0030	0000	0000	0011	0000	
+4						Command parameter Block number (0 to 2047)
+5						

- Response

First word in Command Area	Command code	Bit				Description
		15-12	11-8	7-4	3-0	
+2	7000	0111	0000	0000	0000	Command code
+3	0030	0000	0000	0100	0000	Target command code for response
+4	0000	0000	0000	0000	0000	Response code Command run result
+5	0000	0000	0000	0000	0000	OK: 0 (0000 0000) NG: Other than 0 (0000 0000)
+6						Block number (0 to 2047)
+7						
+8						1st character
+9						2nd character
+10						3rd character
+11						4th character
+12						5th character
+13						6th character
+14						7th character
+15						8th character
+16						9th character
+17						10th character
+18						11st character
+19						12nd character
+20						13th character
+21						14th character
+22						15th character
+23						16th character
+24						17th character
+25						18th character
+26						19th character
+27						20th character
+28						21st character
+29						22nd character
+30						23rd character
+31						24th character
+32						25th character
+33						26th character

First word in Command Area	Command code	Bit				Description
		15-12	11-8	7-4	3-0	
+34						27th character
+35						28th character
+36						29th character
+37						30th character
+38						31st character
+39						32nd character
+40						33rd character
+41						34th character
+42						35th character
+43						36th character
+44						37th character
+45						38th character
+46						39th character
+47						40th character

Block processing parameter setting

- Command

First word in Command Area	Command code	Bit				Description
		15-12	11-8	7-4	3-0	
+2	5000	0101	0000	0000	0000	Command code
+3	0030	0000	0000	0011	0000	
+4						Command parameter
+5						Block No. *1 Block No. to set
+6						Power coefficient
+7						1 to 100 Unit: %
+8						Frequency
+9						Standard mode: 10 to 1000 EE mode: 10 to 100 Unit: kHz
+10						Pulse shape
+11						Standard mode: 1 to 15 EE mode: 1 to 3
+12						Processing speed
+13						1 to 12000 Unit: mm/s
+14						Power coefficient (Light module) *2
+15						1 to 100 Unit: %
+16						Frequency (Light module) *2
+17						Standard mode: 10 to 1000 EE mode: 10 to 100 Unit: kHz
+18						Pulse shape (Light module) *2
+19						Standard mode: 1 to 15 EE mode: 1 to 3

*1 Cannot be omitted

*2 For QR codes and Data Matrix, the light module setting values are entered.
For other blocks, the setting values are invalid.

- Response

First word in Response Area	Command code	Bit				Description
		15-12	11-8	7-4	3-0	
+2	5000	0101	0000	0000	0000	Command code
+3	0030	0000	0000	0011	0000	Target command code for response
+4	-	0000	0000	0000	0000	Response code
+5	-	0000	0000	0000	0000	Command run result OK: 0 (0000 0000) NG: Other than 0 (0000 0000)

Block processing parameter acquisition

- Command

First word in Command Area	Command code	Bit				Description
		15-12	11-8	7-4	3-0	
+2	5010	0101	0000	0001	0000	Command code
+3	0030	0000	0000	0011	0000	
+4						Command parameter Block No. Block No. to acquire

- Response

First word in Response Area	Command code	Bit				Description
		15-12	11-8	7-4	3-0	
+2	5010	0101	0000	0001	0000	Command code
+3	0030	0000	0000	0011	0000	Target command code for response
+4	-	0000	0000	0000	0000	Response code
+5	-	0000	0000	0000	0000	Command run result OK: 0 (0000 0000) NG: Other than 0 (0000 0000)
+6						Response parameter Power coefficient Unit: %
+7						
+8						Frequency Unit: kHz
+9						
+10						Pulse shape Pattern No.
+11						
+12						Processing speed Unit: mm/s
+13						
+14						Power coefficient (Light module) *1 Unit: %
+15						
+16						Frequency (Light module) *1 Unit: kHz
+17						
+18						Pulse shape (Light module) *1 Pattern No.
+19						

*1 For QR codes and Data Matrix, the light module setting values are entered.
For other blocks, the setting values are invalid.

Marking data name setting



Precautions for Correct Use

This command can open marking data names of 40 characters or less. Only ASCII or Shift-JIS character codes can be set with this command.

To set the character code to ASCII, set the lower 8 bits.

If only the upper 8 bits are set, they are considered to be the end of the character string.

When 0 (0000 0000) is set in channel 1, it is considered to be the end of the character string.

- Command

First word in Command Area	Command code	Bit				Description
		15-12	11-8	7-4	3-0	
+2	7000	0111	0000	0000	0000	Command code
+3	0040	0000	0000	0100	0000	
+4						Command parameter 1st character
+5						2nd character
+6						3rd character
+7						4th character
+8						5th character
+9						6th character
+10						7th character
+11						8th character
+12						9th character
+13						10th character
+14						11st character
+15						12nd character
+16						13th character
+17						14th character
+18						15th character
+19						16th character
+20						17th character
+21						18th character
+22						19th character
+23						20th character
+24						21st character
+25						22nd character
+26						23rd character
+27						24th character
+28						25th character
+29						26th character
+30						27th character
+31						28th character
+32						29th character
+33						30th character
+34						31st character
+35						32nd character
+36						33rd character
+37						34th character
+38						35th character
+39						36th character
+40						37th character

First word in Command Area	Command code	Bit				Description
		15-12	11-8	7-4	3-0	
+41						38th character
+42						39th character
+43						40th character

- Response

First word in Response Area	Command code	Bit				Description
		15-12	11-8	7-4	3-0	
+2	7000	0111	0000	0000	0000	Command code
+3	0040	0000	0000	0100	0000	Target command code for response
+4		0000	0000	0000	0000	Response code Command run result
+5		0000	0000	0000	0000	OK:0(0000 0000) NG:0(0000 0000)

Marking data name acquisition



Precautions for Correct Use

Up to 40 characters can be acquired with this command.
Only ASCII or Shift-JIS character codes can be acquired with this command.

- Command

First word in Command Area	Command code	Bit				Description
		15-12	11-8	7-4	3-0	
+2	7010	0111	0000	0001	0000	Command code
+3	0040	0000	0000	0100	0000	

- Response

First word in Response Area	Command code	Bit				Description
		15-12	11-8	7-4	3-0	
+2	7010	0111	0000	0001	0000	Command code
+3	0040	0000	0000	0100	0000	Target command code for response
+4		0000	0000	0000	0000	Response code
+5		0000	0000	0000	0000	Command run result OK:0 (0000 0000) NG: Other than 0 (0000 0000)
+6						Response parameter Y
+7						Y
+8						Y
+9						Y
+10						M
+11						M
+12						D
+13						D
+14						h
+15						h
+16						m
+17						m
+18						s
+19						s

Time hold setting

- Command

First word in Command Area	Command code	Bit				Description
		15-12	11-8	7-4	3-0	
+2	9000	1001	0000	0000	0000	Command code
+3	0040	0000	0000	0100	0000	
+4						Date/time specification 0: Time hold reset 1: Not specified (Command received date and time) 2: Specified
+5						
+6						Y (units of 1,000)
+7						Y (units of 100)
+8						Y (units of 10)
+9						Y (units of 1)
+10						M (units of 10)
+11						M (units of 1)
+12						D (units of 10)
+13						D (units of 1)
+14						h (units of 10)
+15						h (units of 1)
+16						m (units of 10)
+17						m (units of 1)
+18						s (units of 10)
+19						s (units of 1)

- Response

First word in Response Area	Command code	Bit				Description
		15-12	11-8	7-4	3-0	
+2	9000	1001	0000	0000	0000	Command code
+3	0040	0000	0000	0100	0000	Target command code for response
+4		0000	0000	0000	0000	Response code Command run result
+5		0000	0000	0000	0000	OK: 0 (0000 0000) NG: Other than 0 (0000 0000)

Time hold status acquisition

- Command

First word in Command Area	Command code	Bit				Description
		15-12	11-8	7-4	3-0	
+2	9010	1001	0000	0001	0000	Command code
+3	0040	0000	0000	0100	0000	

- Response

First word in Response Area	Command code	Bit				Description
		15-12	11-8	7-4	3-0	
+2	9010	1001	0000	0001	0000	Command code
+3	0040	0000	0000	0100	0000	Target command code for response
+4		0000	0000	0000	0000	Response code
+5		0000	0000	0000	0000	Command run result OK: 0 (0000 0000) NG: Other than 0 (0000 0000)
+6						Response parameter
+7						Date/time specification 0: No time hold 1: Time hold in process
+8						Y (units of 1,000)
+9						Y (units of 100)
+10						Y (units of 10)
+11						Y (units of 1)
+12						M (units of 10)
+13						M (units of 1)
+14						D (units of 10)
+15						D (units of 1)
+16						h (units of 10)
+17						h (units of 1)
+18						m (units of 10)
+19						m (units of 1)
+20						s (units of 10)
+21						s (units of 1)

Counter setting

- Command

First word in Command Area	Command code	Bit				Description
		15-12	11-8	7-4	3-0	
+2	1000	0001	0000	0000	0000	Command code
+3	0040	0000	0000	0100	0000	
+4						Command parameter Counter No. 0 to 15
+5						
+6						Counter enabled/disabled? 0: Disabled 1: Enabled
+7						
+8						Initial value Counter initial value
+9						
+10						End value Counter end value
+11						
+12						Step Number of counter steps
+13						
+14						Current value Current counter value
+15						
+16						Initialization timing 0: Start marking 1: New sheet 3: Power supply ON 4: OFF 5: Change marking data
+17						
+18						Count timing 0: Every marking 1: Every sheet 2: Every cell 3: Command change only
+19						
+20						Count complete action 0: Error stop 1: Stop counter, resume at initial value. 2: Stop counter, resume at end value. 3: Auto-loop
+21						
+22						Count complete output 0: None 1: A 2: B 3: C 4: D
+23						
+24						Output type 0: Pulse 1: Level
+25						

- Response

First word in Response Area	Command code	Bit				Description
		15-12	11-8	7-4	3-0	
+2	1000	0001	0000	0000	0000	Command code
+3	0040	0000	0000	0100	0000	Target command code for response
+4	-	0000	0000	0000	0000	Response code
+5	-	0000	0000	0000	0000	Command run result OK: 0 (0000 0000) NG: Other than 0 (0000 0000)

Counter setting acquisition

- Command

First word in Command Area	Command code	Bit				Description
		15-12	11-8	7-4	3-0	
+2	1010	0001	0000	0001	0000	Command code
+3	0040	0000	0000	0100	0000	
+4						Command parameter Counter No. 0 to 15

- Response

First word in Response Area	Command code	Bit				Description
		15-12	11-8	7-4	3-0	
+2	1010	0001	0000	0001	0000	Command code
+3	0040	0000	0000	0100	0000	Target command code for response
+4	-	0000	0000	0000	0000	Response code
+5	-	0000	0000	0000	0000	Command run result OK: 0 (0000 0000) NG: Other than 0 (0000 0000)
+6						Counter enabled/disabled 0: Disabled 1: Enabled
+7						
+8						Initial value Counter initial value
+9						
+10						End value Counter end value
+11						
+12						Step Number of counter steps
+13						
+14						Current value Current counter value
+15						
+16						Initialization timing 0: Start marking 1: New sheet 3: Power supply ON 4: OFF 5: Change marking data
+17						
+18						Count timing 0: Every marking 1: Every sheet 2: Every cell 3: Command change only
+19						
+20						Count complete action 0: Error stop 1: Stop counter, resume at initial value. 2: Stop counter, resume at end value. 3: Auto-loop
+21						
+22						Count complete output 0: None 1: A 2: B 3: C 4: D
+23						
+24						Output type 0: Pulse 1: Level
+25						

Count up

- Command

First word in Command Area	Command code	Bit				Description
		15-12	11-8	7-4	3-0	
+2	1020	0001	0000	0010	0000	Command code
+3	0040	0000	0000	0100	0000	
+4						Command parameter Counter specification Specifies 0x0000 to 0xFFFF for counters 0 to 15. (Specifies the bit equivalent to the counter from the least significant.) 0: Not specify 1: Specify
+5						
+6						Count type 0: Count up 1: Count down
+7						

- Response

First word in Response Area	Command code	Bit				Description
		15-12	11-8	7-4	3-0	
+2	1020	0001	0000	0010	0000	Command code
+3	0040	0000	0000	0100	0000	Target command code for response
+4	-	0000	0000	0000	0000	Response code
+5	-	0000	0000	0000	0000	Command run result OK: 0 (0000 0000) NG: Other than 0 (0000 0000)

Counter reset

- Command

First word in Command Area	Command code	Bit				Description
		15-12	11-8	7-4	3-0	
+2	1030	0001	0000	0011	0000	Command code
+3	0040	0000	0000	0100	0000	
+4						Command parameter Counter specification Specifies 0x0000 to 0xFFFF for counters 0 to 15. (Specifies the bit equivalent to the counter from the least significant.) 0: Not specify 1: Specify
+5						

- Response

First word in Response Area	Command code	Bit				Description
		15-12	11-8	7-4	3-0	
+2	1030	0001	0000	0011	0000	Command code
+3	0040	0000	0000	0100	0000	Target command code for response
+4	-	0000	0000	0000	0000	Response code
+5	-	0000	0000	0000	0000	Command run result OK: 0 (0000 0000) NG: Other than 0 (0000 0000)

Counter status acquisition

- Command

First word in Command Area	Command code	Bit				Description
		15-12	11-8	7-4	3-0	
+2	1040	0001	0000	0100	0000	Command code
+3	0040	0000	0000	0100	0000	

- Response

First word in Response Area	Command code	Bit				Description
		15-12	11-8	7-4	3-0	
+2	1040	0001	0000	0100	0000	Command code
+3	0040	0000	0000	0100	0000	Target command code for response
+4	-	0000	0000	0000	0000	Response code
+5	-	0000	0000	0000	0000	Command run result OK: 0 (0000 0000) NG: Other than 0 (0000 0000)
+6						Response parameter Counter No. 0 0: Not used 1: In use 2: Count complete
+7						
+8						Counter No. 1 Same as "Counter No. 0"
+9						
+10						Counter No. 2 Same as "Counter No. 0"
+11						
+12						Counter No. 3 Same as "Counter No. 0"
+13						
+14						Counter No. 4 Same as "Counter No. 0"
+15						
+16						Counter No. 5 Same as "Counter No. 0"
+17						
+18						Counter No. 6 Same as "Counter No. 0"
+19						
+20						Counter No. 7 Same as "Counter No. 0"
+21						
+22						Counter No. 8 Same as "Counter No. 0"
+23						
+24						Counter No. 9 Same as "Counter No. 0"
+25						
+26						Counter No. 10 Same as "Counter No. 0"
+27						
+28						Counter No. 11 Same as "Counter No. 0"
+29						
+30						Counter No. 12 Same as "Counter No. 0"
+31						
+32						Counter No. 13 Same as "Counter No. 0"
+33						
+34						Counter No. 14 Same as "Counter No. 0"
+35						
+36						Counter No. 15 Same as "Counter No. 0"
+37						

Variable data table index specification

- Command

First word in Command Area	Command code	Bit				Description
		15-12	11-8	7-4	3-0	
+2	1050	0001	0000	0101	0000	Command code
+3	0040	0000	0000	0100	0000	
+4						Command parameter Table type 0: String 1: Image 2: Shape
+5						
+6						Table No. 0 to 63
+7						
+8						Index No. 0 to 255
+9						

- Response

First word in Response Area	Command code	Bit				Description
		15-12	11-8	7-4	3-0	
+2	1050	0001	0000	0101	0000	Command code
+3	0040	0000	0000	0100	0000	Target command code for response
+4	-	0000	0000	0000	0000	Response code
+5	-	0000	0000	0000	0000	Command run result OK: 0 (0000 0000) NG: Other than 0 (0000 0000)

Variable data table index acquisition

- Command

First word in Command Area	Command code	Bit				Description
		15-12	11-8	7-4	3-0	
+2	1060	0001	0000	0110	0000	Command code
+3	0040	0000	0000	0100	0000	
+4						Command parameter Table type 0: String 1: Image 2: Shape
+5						
+6						Table No. 0 to 63
+7						

- Response

First word in Response Area	Command code	Bit				Description
		15-12	11-8	7-4	3-0	
+2	1060	0001	0000	0110	0000	Command code
+3	0040	0000	0000	0100	0000	Target command code for response
+4	-	0000	0000	0000	0000	Response code Command run result
+5	-	0000	0000	0000	0000	OK: 0 (0000 0000) NG: Other than 0 (0000 0000)
+6						Response parameter Index No. Index No.
+7						

Marking data No. specification

- Command

First word in Command Area	Command code	Bit				Description
		15-12	11-8	7-4	3-0	
+2	2000	0010	0000	0000	0000	Command code
+3	0040	0000	0000	0100	0000	
+4						Command parameter Marking data No. 0 to 9999
+5						

- Response

First word in Response Area	Command code	Bit				Description
		15-12	11-8	7-4	3-0	
+2	2000	0010	0000	0000	0000	Command code
+3	0040	0000	0000	0100	0000	Target command code for response
+4	-	0000	0000	0000	0000	Response code Command run result
+5	-	0000	0000	0000	0000	OK: 0 (0000 0000) NG: Other than 0 (0000 0000)

Marking data No. acquisition

- Command

First word in Command Area	Command code	Bit				Description
		15-12	11-8	7-4	3-0	
+2	2010	0010	0000	0001	0000	Command code
+3	0040	0000	0000	0100	0000	

- Response

First word in Response Area	Command code	Bit				Description
		15-12	11-8	7-4	3-0	
+2	2010	0010	0000	0001	0000	Command code
+3	0040	0000	0000	0100	0000	Target command code for response
+4	-	0000	0000	0000	0000	Response code Command run result
+5	-	0000	0000	0000	0000	OK: 0 (0000 0000) NG: Other than 0 (0000 0000)
+6						Command parameter Marking data No. 0 to 9999
+7						

Position correction value setting

- Command

First word in Command Area	Command code	Bit				Description
		15-12	11-8	7-4	3-0	
+2	3000	0011	0000	0000	0000	Command code
+3	0040	0000	0000	0100	0000	
+4						Command parameter X axis Type MX-Z2000H-V1: -45000 to 45000 Type MX-Z2050H-V1/Z2055H-V1: -80000 to 80000 Unit: 1/1000 mm
+5						
+6						Y axis Type MX-Z2000H-V1: -45000 to 45000 Type MX-Z2050H-V1/Z2055H-V1: -80000 to 80000 Unit: 1/1000 mm
+7						
+8						Z axis -10000 to 10000 Unit: 1/1000 mm
+9						
+10						θZ axis -4500 to 4500 Unit: 1/100°
+11						

- Response

First word in Response Area	Command code	Bit				Description
		15-12	11-8	7-4	3-0	
+2	3000	0011	0000	0000	0000	Command code
+3	0040	0000	0000	0100	0000	Target command code for response
+4	-	0000	0000	0000	0000	Response code
+5	-	0000	0000	0000	0000	Command run result OK: 0 (0000 0000) NG: Other than 0 (0000 0000)

Position correction value acquisition

- Command

First word in Command Area	Command code	Bit				Description
		15-12	11-8	7-4	3-0	
+2	3010	0011	0000	0001	0000	Command code
+3	0040	0000	0000	0100	0000	

- Response

First word in Response Area	Command code	Bit				Description
		15-12	11-8	7-4	3-0	
+2	3010	0011	0000	0001	0000	Command code
+3	0040	0000	0000	0100	0000	Target command code for response
+4	-	0000	0000	0000	0000	Response code
+5	-	0000	0000	0000	0000	Command run result OK: 0 (0000 0000) NG: Other than 0 (0000 0000)
+6						Response parameter X axis Unit: 1/1000 mm
+7						
+8						Y axis Unit: 1/1000 mm
+9						
+10						Z axis Unit: 1/1000 mm
+11						
+12						θZ axis Unit: 1/100°
+13						

Guide laser setting

- Command

First word in Command Area	Command code	Bit				Description
		15-12	11-8	7-4	3-0	
+2	3020	0011	0000	0010	0000	Command code
+3	0040	0000	0000	0100	0000	
+4						Command parameter Guide laser type 0: Marking data (processing laser) 1: Marking area (guide laser) 2: Area guide (guide laser) 3: Center point (guide laser) 10: Marking data (guide laser) 15: Marking area (guide laser) 16: Block frame (guide laser) 20: Focus guide (guide laser) Note: When the system is set to guide laser, the marking count is set to infinite.
+5						
+6						When the guide laser type is 0, 1, 2, 3, 10 or 20 No need to set When guide laser type is 15 Specify X (Column No.) When guide laser type is 16 Specify block no. (0000 to 2047)
+7						
+8						When guide laser type is not 15 No need to set When guide laser type is 15 Specify Y (row no.)
+9						

- Response

First word in Response Area	Command code	Bit				Description
		15-12	11-8	7-4	3-0	
+2	3020	0011	0000	0010	0000	Command code
+3	0040	0000	0000	0100	0000	Target command code for response
+4		0000	0000	0000	0000	Response code
+5		0000	0000	0000	0000	Command run result OK: 0 (0000 0000) NG: Other than 0 (0000 0000)

Guide laser acquisition

- Command

First word in Command Area	Command code	Bit				Description
		15-12	11-8	7-4	3-0	
+2	3030	0011	0000	0011	0000	Command code
+3	0040	0000	0000	0100	0000	

- Response

First word in Response Area	Command code	Bit				Description
		15-12	11-8	7-4	3-0	
+2	3030	0011	0000	0011	0000	Command code
+3	0040	0000	0000	0100	0000	Target command code for response
+4		0000	0000	0000	0000	Response code
+5		0000	0000	0000	0000	Command run result OK: 0 (0000 0000) NG: Other than 0 (0000 0000)
+6						Command parameter
+7						Guide laser type 0: Marking data (processing laser) 1: Marking area (guide laser) 2: Area guide (guide laser) 3: Center point (guide laser) 10: Marking data (guide laser) 15: Marking area (guide laser) 16: Block frame (guide laser) 20: Focus guide (guide laser)
+8						When the guide laser type is 0, 1, 2, 3, 10 or 20 0
+9						When guide laser type is 15 X (Column No.) When guide laser type is 16 Specify block no. (0000 to 2047)
+10						When guide laser type is not 15 0
+11						When guide laser type is 15 Y (row no.)

Open the shutter

- Command

First word in Command Area	Command code	Bit				Description
		15-12	11-8	7-4	3-0	
+2	4000	0100	0000	0000	0000	Command code
+3	0040	0000	0000	0100	0000	

- Response

First word in Response Area	Command code	Bit				Description
		15-12	11-8	7-4	3-0	
+2	4000	0100	0000	0000	0000	Command code
+3	0040	0000	0000	0100	0000	Target command code for response
+4	-	0000	0000	0000	0000	Response code
+5	-	0000	0000	0000	0000	Command run result OK: 0 (0000 0000) NG: Other than 0 (0000 0000)

Close the shutter

- Command

First word in Command Area	Command code	Bit				Description
		15-12	11-8	7-4	3-0	
+2	4010	0100	0000	0001	0000	Command code
+3	0040	0000	0000	0100	0000	

- Response

First word in Response Area	Command code	Bit				Description
		15-12	11-8	7-4	3-0	
+2	4010	0100	0000	0001	0000	Command code
+3	0040	0000	0000	0100	0000	Target command code for response
+4	-	0000	0000	0000	0000	Response code
+5	-	0000	0000	0000	0000	Command run result OK: 0 (0000 0000) NG: Other than 0 (0000 0000)

Device status acquisition

- Command

First word in Command Area	Command code	Bit				Description
		15-12	11-8	7-4	3-0	
+2	4020	0100	0000	0010	0000	Command code
+3	0040	0000	0000	0100	0000	

- Response

First word in Response Area	Command code	Bit				Description
		15-12	11-8	7-4	3-0	
+2	4020	0100	0000	0010	0000	Command code
+3	0040	0000	0000	0100	0000	Target command code for response
+4	-	0000	0000	0000	0000	Response code Command run result
+5	-	0000	0000	0000	0000	OK: 0 (0000 0000) NG: Other than 0 (0000 0000)
+6						Response parameter Laser power (LASER) 0: OFF 1: ON
+7						
+8						Marking stop (STOP) 0: OFF 1: ON
+9						
+10						Error (ERROR) 0: OFF 1: ON
+11						
+12						Shutter (SHUTTER) 0: OFF (Closed), 1: ON (Open) 0: OFF 1: ON
+13						
+14						Marking ready (MARK READY) 0: OFF 1: ON
+15						
+16						Emergency stop 0: OFF 1: ON
+17						

Marking start

- Command

First word in Command Area	Command code	Bit				Description
		15-12	11-8	7-4	3-0	
+2	4030	0100	0000	0011	0000	Command code
+3	0040	0000	0000	0100	0000	

- Response

First word in Response Area	Command code	Bit				Description
		15-12	11-8	7-4	3-0	
+2	4030	0100	0000	0011	0000	Command code
+3	0040	0000	0000	0100	0000	Target command code for response
+4	-	0000	0000	0000	0000	Response code
+5	-	0000	0000	0000	0000	Command run result OK: 0 (0000 0000) NG: Other than 0 (0000 0000)

Marking stop

- Command

First word in Command Area	Command code	Bit				Description
		15-12	11-8	7-4	3-0	
+2	4040	0100	0000	0100	0000	Command code
+3	0040	0000	0000	0100	0000	

- Response

First word in Response Area	Command code	Bit				Description
		15-12	11-8	7-4	3-0	
+2	4040	0100	0000	0100	0000	Command code
+3	0040	0000	0000	0100	0000	Target command code for response
+4	-	0000	0000	0000	0000	Response code
+5	-	0000	0000	0000	0000	Command run result OK: 0 (0000 0000) NG: Other than 0 (0000 0000)

Warm-up start

- Command

First word in Command Area	Command code	Bit				Description
		15-12	11-8	7-4	3-0	
+2	4050	0100	0000	0101	0000	Command code
+3	0040	0000	0000	0100	0000	

- Response

First word in Response Area	Command code	Bit				Description
		15-12	11-8	7-4	3-0	
+2	4050	0100	0000	0101	0000	Command code
+3	0040	0000	0000	0100	0000	Target command code for response
+4	-	0000	0000	0000	0000	Response code Command run result
+5	-	0000	0000	0000	0000	OK: 0 (0000 0000) NG: Other than 0 (0000 0000)

10

Device information setting

- Command

First word in Command Area	Command code	Bit				Description
		15-12	11-8	7-4	3-0	
+2	4060	0100	0000	0110	0000	Command code
+3	0040	0000	0000	0100	0000	
+4						Command parameter Target 1: Accumulated laser operation time 2: Operation time 3: Total marking time 4: Maintenance time 5: Button battery usage time
+5						
+6						Current value Target current value
+7						
+8						Alarm Target alarm set value
+9						

- Response

First word in Response Area	Command code	Bit				Description
		15-12	11-8	7-4	3-0	
+2	4060	0100	0000	0110	0000	Command code
+3	0040	0000	0000	0100	0000	Target command code for response
+4		0000	0000	0000	0000	Response code Command run result
+5		0000	0000	0000	0000	OK: 0 (0000 0000) NG: Other than 0 (0000 0000)

Device information acquisition

• Command

First word in Command Area	Command code	Bit				Description
		15-12	11-8	7-4	3-0	
+2	4070	0100	0000	0111	0000	Command code
+3	0040	0000	0000	0100	0000	
+4						Command parameter Target 1: Accumulated laser operation time 2: Operation time 3: Total marking time 4: Maintenance time 5: Button battery usage time
+5						

• Response

First word in Response Area	Command code	Bit				Description
		15-12	11-8	7-4	3-0	
+2	4070	0100	0000	0111	0000	Command code
+3	0040	0000	0000	0100	0000	Target command code for response
+4		0000	0000	0000	0000	Response code
+5		0000	0000	0000	0000	Command run result OK: 0 (0000 0000) NG: Other than 0 (0000 0000)
+6						Command parameter Target 1: Accumulated laser operation time 2: Operation time 3: Total marking time 4: Maintenance time 5: Button battery usage time 6: No. of times relay opens/closes
+7						
+8						Current value
+9						Target current value
+10						Alarm
+11						Target alarm set value

Marking status acquisition

- Command

First word in Command Area	Command code	Bit				Description
		15-12	11-8	7-4	3-0	
+2	5000	0101	0000	0000	0000	Command code
+3	0040	0000	0000	0100	0000	

- Response

First word in Response Area	Command code	Bit				Description
		15-12	11-8	7-4	3-0	
+2	5000	0101	0000	0000	0000	Command code
+3	0040	0000	0000	0100	0000	Target command code for response
+4	-	0000	0000	0000	0000	Response code
+5	-	0000	0000	0000	0000	Command run result OK: 0 (0000 0000) NG: Other than 0 (0000 0000)
+6						Response parameter Marking (MARK BUSY) 0: OFF (Marking stopped) 1: ON (Marking)
+7						
+8						Alarm (ALARM) 0: OFF 1: ON
+9						
+10						Laser power (LASER) 0: OFF 1: ON
+11						
+12						Error (ERROR) 0: OFF 1: ON
+13						
+14						Shutter (SHUTTER) 0: OFF (Closed) 1: ON (Open)
+15						
+16						Marking ready (MARK READY) 0: OFF 1: ON
+17						
+18						Emergency stop 0: OFF 1: ON
+19						

Backup



Precautions for Correct Use

You cannot specify the backup destination folder with this command.
The backup data is saved in the default path of the marker when this command is executed.
The default path of the marker is "F:\backup\(Device ID)".

- Command

First word in Command Area	Command code	Bit				Description
		15-12	11-8	7-4	3-0	
+2	5040	0101	0000	0100	0000	Command code
+3	0040	0000	0000	0100	0000	

- Response

First word in Response Area	Command code	Bit				Description
		15-12	11-8	7-4	3-0	
+2	5040	0101	0000	0100	0000	Command code
+3	0040	0000	0000	0100	0000	Target command code for response
+4		0000	0000	0000	0000	Response code Command run result
+5		0000	0000	0000	0000	OK: 0 (0000 0000) NG: Other than 0 (0000 0000)

Restore



Precautions for Correct Use

You cannot specify the restore source folder with this command.
The restore data is restored from the default path of the marker when this command is executed.
The default path of the marker is "F:\backup\(Device ID)".

- Command

First word in Command Area	Command code	Bit				Description
		15-12	11-8	7-4	3-0	
+2	5050	0101	0000	0101	0000	Command code
+3	0040	0000	0000	0100	0000	

- Response

First word in Response Area	Command code	Bit				Description
		15-12	11-8	7-4	3-0	
+2	5050	0101	0000	0101	0000	Command code
+3	0040	0000	0000	0100	0000	Target command code for response
+4		0000	0000	0000	0000	Response code Command run result
+5		0000	0000	0000	0000	OK: 0 (0000 0000) NG: Other than 0 (0000 0000)

Power monitor measurement

- Command

First word in Command Area	Command code	Bit				Description
		15-12	11-8	7-4	3-0	
+2	5010	0101	0000	0001	0000	Command code
+3	0040	0000	0000	0100	0000	

- Response

First word in Response Area	Command code	Bit				Description
		15-12	11-8	7-4	3-0	
+2	5010	0101	0000	0001	0000	Command code
+3	0040	0000	0000	0100	0000	Target command code for response
+4	-	0000	0000	0000	0000	Response code Command run result
+5	-	0000	0000	0000	0000	OK: 0 (0000 0000) NG: Other than 0 (0000 0000)
+6						Response parameter
+7						Measurement value Unit: %

Laser power monitor setting change

- Command

First word in Command Area	Command code	Bit				Description
		15-12	11-8	7-4	3-0	
+2	6000	0110	0000	0000	0000	Command code
+3	0040	0000	0000	0100	0000	
+4						Command parameter Monitor setting 0: Disabled 1: Enabled
+5						
+6						Laser power lower limit value 10 to 200 Unit: %
+7						
+8						Laser monitor setting 0: Only at start 1: Only at start marking 2: Only at end of marking 3: At start + at start marking 4: At start + at end of marking 5: At start + at start and end of marking 6: At start marking + at end of marking 7: None
+9						
+10						Monitor timing 0: At each marking 1: Every marking count specified
+11						
+12						Marking count 1 to 9999 Unit: Count
+13						

- Response

First word in Response Area	Command code	Bit				Description
		15-12	11-8	7-4	3-0	
+2	6000	0110	0000	0000	0000	Command code
+3	0040	0000	0000	0100	0000	Target command code for response
+4	-	0000	0000	0000	0000	Response code
+5	-	0000	0000	0000	0000	Command run result OK: 0 (0000 0000) NG: Other than 0 (0000 0000)

Laser power monitor setting acquisition

- Command

First word in Command Area	Command code	Bit				Description
		15-12	11-8	7-4	3-0	
+2	6010	0110	0000	0001	0000	Command code
+3	0040	0000	0000	0100	0000	

- Response

First word in Response Area	Command code	Bit				Description
		15-12	11-8	7-4	3-0	
+2	6010	0110	0000	0001	0000	Command code
+3	0040	0000	0000	0100	0000	Target command code for response
+4	-	0000	0000	0000	0000	Response code
+5	-	0000	0000	0000	0000	Command run result OK: 0 (0000 0000) NG: Other than 0 (0000 0000)
+6						Response parameter Monitor setting 0: Disabled 1: Enabled
+7						
+8						Laser power lower limit value 10 to 200 Unit: %
+9						
+10						Laser monitor setting 0: Only at start 1: Only at start marking 2: Only at end of marking 3: At start + at start marking 4: At start + at end of marking 5: At start + at start and end of marking 6: At start marking + at end of marking 7: None
+11						
+12						Monitor timing 0: At each marking 1: Every marking count specified
+13						
+14						Marking count 1 to 9999 Unit: Count
+15						

Traceability log setting parameter change

• Command

First word in Command Area	Command code	Bit				Description
		15-12	11-8	7-4	3-0	
+2	8000	1000	0000	0000	0000	Command code
+3	0040	0000	0000	0100	0000	
+4						Command parameter Output info 0: Not output 1: Output
+5						
+6						Marking data 0: Not output 1: Output
+7						
+8						Counter Info 0: Not output 1: Output
+9						
+10						Marking time 0: Not output 1: Output
+11						
+12						Power check result 0: Not output 1: Output
+13						
+14						Specification block 0: Not output 1: Output
+15						
+16						Block No. Enabled when the specification block data information is set to "1".
+17						
+18						Accumulated laser operation time 0: Not output 1: Output
+19						
+20						Operation time 0: Not output 1: Output
+21						
+22						Total marking time 0: Not output 1: Output
+23						
+24						Maintenance time 0: Not output 1: Output
+25						
+26						Button battery usage time 0: Not output 1: Output
+27						

• Response

First word in Response Area	Command code	Bit				Description
		15-12	11-8	7-4	3-0	
+2	8000	1000	0000	0000	0000	Command code
+3	0040	0000	0000	0100	0000	Target command code for response
+4		0000	0000	0000	0000	Response code
+5		0000	0000	0000	0000	Command run result OK: 0 (0000 0000) NG: Other than 0 (0000 0000)

Traceability log setting parameter acquisition

• Command

First word in Command Area	Command code	Bit				Description
		15-12	11-8	7-4	3-0	
+2	8010	1000	0000	0001	0000	Command code
+3	0040	0000	0000	0100	0000	

• Response

First word in Response Area	Command code	Bit				Description
		15-12	11-8	7-4	3-0	
+2	8010	1000	0000	0001	0000	Command code
+3	0040	0000	0000	0100	0000	Target command code for response
+4		0000	0000	0000	0000	Response code
+5		0000	0000	0000	0000	Command run result OK: 0 (0000 0000) NG: Other than 0 (0000 0000)
+6						Response parameter
+7						Output info 0: Not output 1: Output
+8						Marking data
+9						0: Not output 1: Output
+10						Counter Info
+11						0: Not output 1: Output
+12						Marking time
+13						0: Not output 1: Output
+14						Power check result
+15						0: Not output 1: Output
+16						Specification block
+17						0: Not output 1: Output
+18						Block No.
+19						Returns "FFFFFFFF" (all 1) when there is nothing set.
+20						Accumulated laser operation time
+21						0: Not output 1: Output
+22						Operation time
+23						0: Not output 1: Output
+24						Total marking time
+25						0: Not output 1: Output
+26						Maintenance time
+27						0: Not output 1: Output
+28						Button battery usage time
+29						0: Not output 1: Output

Date/time setting



Precautions for Correct Use

Enter 1 ASCII code character per channel in the "YYYYMMDDhhmmss" format.

- Command

First word in Command Area	Command code	Bit				Description
		15-12	11-8	7-4	3-0	
+2	2000	0111	0000	0000	0000	Command code
+3	0050	0000	0000	0100	0000	
+4						Command parameter Y
+5						Y
+6						Y
+7						Y
+8						M
+9						M
+10						D
+11						D
+12						h
+13						h
+14						m
+15						m
+16						s
+17						s

- Response

First word in Response Area	Command code	Bit				Description
		15-12	11-8	7-4	3-0	
+2	2000	0111	0000	0000	0000	Command code
+3	0050	0000	0000	0100	0000	Target command code for response
+4		0000	0000	0000	0000	Response code Command run result
+5		0000	0000	0000	0000	OK: 0 (0000 0000) NG: Other than 0 (0000 0000)

Date/time acquisition

**Precautions for Correct Use**

"YYYYMMDDhhmmss" format, character per channel is output as ASCII code.

- Command

First word in Command Area	Command code	Bit				Description
		15-12	11-8	7-4	3-0	
+2	2010	0111	0000	0001	0000	Command code
+3	0050	0000	0000	0100	0000	

- Response

First word in Response Area	Command code	Bit				Description
		15-12	11-8	7-4	3-0	
+2	2010	0111	0000	0001	0000	Command code
+3	0050	0000	0000	0100	0000	Target command code for response
+4		0000	0000	0000	0000	Response code
+5		0000	0000	0000	0000	Command run result OK: 0 (0000 0000) NG: Other than 0 (0000 0000)
+6						Response parameter Y
+7						Y
+8						Y
+9						Y
+10						M
+11						M
+12						D
+13						D
+14						h
+15						h
+16						m
+17						m
+18						s
+19						s

Power check execution

- Command

First word in Command Area	Command code	Bit				Description
		15-12	11-8	7-4	3-0	
+2	1000	0001	0000	0000	0000	Command code
+3	0050	0000	0000	0101	0000	

- Response

First word in Response Area	Command code	Bit				Description
		15-12	11-8	7-4	3-0	
+2	1000	0001	0000	0000	0000	Command code
+3	0050	0000	0000	0101	0000	Target command code for response
+4	-	0000	0000	0000	0000	Response code
+5	-	0000	0000	0000	0000	Command run result OK: 0 (0000 0000) NG: Other than 0 (0000 0000)

10.7 Command Settings

2's Complement

2's complement is a commonly used way to represent negative numbers using binary numbers. Negative numbers are expressed by "Inverting all bits of a positive number and adding 1 to the result".

(Example) "-1" is expressed as 2's complement

"-1" can be calculated by "0-1".

$$\begin{array}{r}
 \text{┌ (In the case of 1, minus 1)} \\
 \text{└} \\
 \text{00000000 (= 0)} \\
 -) \text{00000001 (= 1)} \\
 \hline
 \text{11111111 (= -1)} \leftarrow \text{"-1" is expressed with 2's Complement (for 8 bits)}
 \end{array}$$

There are methods for simple calculation without performing this kind of computation.

For instance, "Negative number = inverting all bits of a positive number and then adding 1 to the result".

$$\begin{array}{r}
 \text{00000001 (= 1)} \\
 \downarrow \text{Invert all bits} \\
 \text{11111110} \\
 \downarrow \text{Plus 1} \\
 \text{11111111 (= -1)}
 \end{array}$$

The first digit is used to judge whether the number is positive or negative.

- When 0: Positive number (or 0)
- When 1: Negative number

The advantage of two's complement numbers is that positive and negative numbers can be used as is in calculations.

(Example) When $-1+10=9$

$$\begin{array}{r}
 \text{11111111 (= -1)} \\
 +) \text{00001010 (= 10)} \\
 \hline
 \text{00001001 (= 9)}
 \end{array}$$

Parameter Notation Examples for Command Control

This section provides examples of binary inputs of parameters and other arguments for command control.



Additional Information

The storage order depends on the manufacturer of the connected PLC as follows:

- OMRON and Yaskawa Electric PLCs: Upper byte followed by lower byte
- Mitsubishi Electric PLCs: Lower byte followed by upper byte

■ **Four-byte Data**

The following example shows the input to cancel alarm only with the Cancel error command.

First word in Command Area	Description
+2 and +3 words	Command code (1000 0010 hex)
+4 and +5 words	Cancel alarm only (0000 0002 hex)

● **OMRON or Yaskawa Electric PLCs**

Command (PLC to Sensor Controller)

First word in Command Area	Hexadecimal notation	Bit				Description
		12 to 15	8 to 11	4 to 7	0 to 3	
+2 word	1000	0001	0000	0000	0000	Command code
+3 word	0010	0000	0000	0001	0000	
+4 word	0002	0000	0000	0000	0010	Cancel target alarm only
+5 word	0000	0000	0000	0000	0000	

● **Mitsubishi Electric PLCs**

Command (PLC to Sensor Controller)

First word in Command Area	Hexadecimal notation	Bit				Description
		12 to 15	8 to 11	4 to 7	0 to 3	
+2 word	1000	0001	0000	0000	0000	Command code
+3 word	0010	0000	0000	0001	0000	
+4 word	0200	0000	0010	0000	0000	Cancel target alarm only
+5 word	0000	0000	0000	0000	0000	

Command Setting Example

When commands are sent through tag data link communications, each command and parameter set values for every 2 channels (4 bytes).

Example: Setting the following parameters with the layer parameter setting command in order to mark the external surface of a sphere

Layer No.: 1

Layer setting: Sphere external

X axis correction: -10 mm

Y axis correction: -20 mm

Z axis correction: +1 mm

Horizontal division count: 8

Vertical division count: 8

θZ correction: 0°

X radius: 15 mm

Y radius: 15 mm

Z radius: 5 mm

First word in Response Area	Hexadecimal notation	Bit				Description
		15 to 12	11 to 8	7 to 4	3 to 0	
+2 word	0030	0000	0000	0011	0000	Command code
+3 word	4000	0100	0000	0000	0000	
+4 word	0001	0000	0000	0000	0001	Layer No.
+5 word	0000	0000	0000	0000	0000	

First word in Response Area	Hexadecimal notation	Bit				Description
		15 to 12	11 to 8	7 to 4	3 to 0	
+6 word	000F	0000	0000	0000	1111	Layer setting
+7 word	0000	0000	0000	0000	0000	
+8 word	D8F0	1101	1000	1111	0000	X axis correction
+9 word	FFFF	1111	1111	1111	1111	
+10 word	B1E0	1011	0001	1110	0000	Y axis correction
+11 word	FFFF	1111	1111	1111	1111	
+12 word	03E8	0000	0011	1110	1000	Z axis correction
+13 word	0000	0000	0000	0000	0000	
+14 word	0000	0000	0000	0000	0000	θX correction
+15 word	0000	0000	0000	0000	0000	
+16 word	0000	0000	0000	0000	0000	θY correction
+17 word	0000	0000	0000	0000	0000	
+18 word	0000	0000	0000	0000	0000	θZ correction
+19 word	0000	0000	0000	0000	0000	
+20 word	0000	0000	0000	0000	0000	Radius
+21 word	0000	0000	0000	0000	0000	
+22 word	0000	0000	0000	0000	0000	Surface division count
+23 word	0000	0000	0000	0000	0000	
+24 word	0000	0000	0000	0000	0000	Height
+25 word	0000	0000	0000	0000	0000	
+26 word	0000	0000	0000	0000	0000	Large circle radius
+27 word	0000	0000	0000	0000	0000	
+28 word	0000	0000	0000	0000	0000	Small circle radius
+29 word	0000	0000	0000	0000	0000	
+30 word	0000	0000	0000	0000	0000	Cone placement
+31 word	0000	0000	0000	0000	0000	
+32 word	0000	0000	0000	0000	0000	Lower circle radius
+33 word	0000	0000	0000	0000	0000	
+34 word	0000	0000	0000	0000	0000	Upper circle radius
+35 word	0000	0000	0000	0000	0000	
+36 word	0008	0000	0000	0000	1000	Horizontal division count
+37 word	0000	0000	0000	0000	0000	
+38 word	0008	0000	0000	0000	1000	Vertical division count
+39 word	0000	0000	0000	0000	0000	
+40 word	3A98	0011	1010	1001	1000	X radius
+41 word	0000	0000	0000	0000	0000	
+42 word	3A98	0011	1010	1001	1000	Y radius
+43 word	0000	0000	0000	0000	0000	
+44 word	1388	0001	0011	1000	1000	Z radius
+45 word	0000	0000	0000	0000	0000	

■ Marking content acquisition



Precautions for Correct Use

Up to 40 characters can be set with this command.
Only ASCII or S-JIS character codes can be set with this command.

• Command

First word in Command Area	Command code	Bit				Description
		15-12	11-8	7-4	3-0	
+2	7000	0111	0000	0000	0000	Command code
+3	0030	0000	0000	0011	0000	
+4						Command parameter Block number (0 to 2047)
+5						

• Response

First word in Command Area	Command code	Bit				Description
		15-12	11-8	7-4	3-0	
+2	7000	0111	0000	0000	0000	Command code
+3	0030	0000	0000	0011	0000	Target command code for response
+4	0000	0000	0000	0000	0000	Response code Command run result
+5	0000	0000	0000	0000	0000	OK: 0 (0000 0000) NG: Other than 0 (0000 0000)
+6						Block number (0 to 2047)
+7						
+8						1st character
+9						2nd character
+10						3rd character
+11						4th character
+12						5th character
+13						6th character
+14						7th character
+15						8th character
+16						9th character
+17						10th character
+18						11st character
+19						12nd character
+20						13th character
+21						14th character
+22						15th character
+23						16th character
+24						17th character
+25						18th character
+26						19th character
+27						20th character
+28						21st character
+29						22nd character
+30						23rd character
+31						24th character
+32						25th character
+33						26th character
+34						27th character

First word in Command Area	Command code	Bit				Description
		15-12	11-8	7-4	3-0	
+35						28th character
+36						29th character
+37						30th character
+38						31st character
+39						32nd character
+40						33rd character
+41						34th character
+42						35th character
+43						36th character
+44						37th character
+45						38th character
+46						39th character
+47						40th character

Chapter 11

How to Use Font Logo Editor

This chapter explains how to use the Font logo editor with which you can create stroke fonts and create/edit logo data to be used with laser marker.

11.1	Functions of Font Logo Editor	11-2
11.2	Starting and Ending Font Logo Editor	11-6
11.3	Screen Configuration and Function of Each Part.....	11-8
11.4	Creating Font	11-29
11.5	Creating Fill Pattern	11-43
11.6	Creating Logo.....	11-45
11.7	Installing Data to Laser Marker	11-55

11.1 Functions of Font Logo Editor

The Font logo editor is a software application loaded with the offline editing software. You can create/edit the stroke fonts, 2D code fill patterns, logo data to be used with laser marker.

The Font logo editor has the following features:

■ Three operation modes

● Creating the font - Font mode -

The Stroke font can be created.

The fonts that are created/edited are registered to the marker software as new font files.

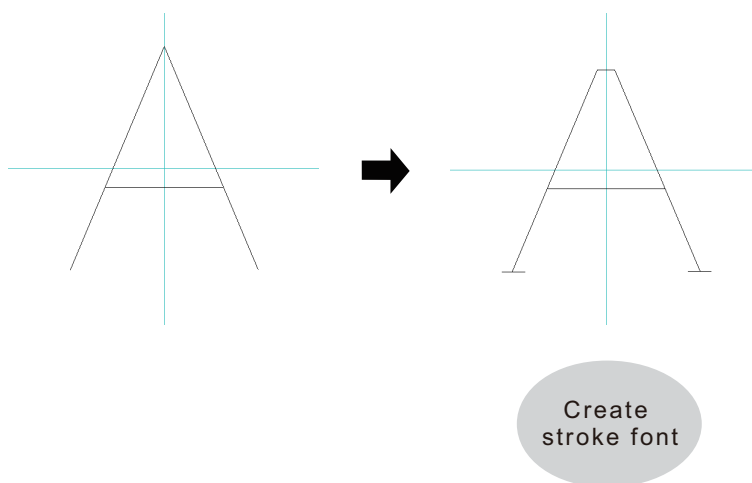

Precautions for Correct Use

Secondary use of fonts

Secondary use of fonts that are loaded with the laser marker and the offline editing software is at your own risk.

OMRON is not responsible for any damage that may result from secondary use of the fonts.

Furthermore, copying, distributing or selling of edited fonts constitutes a copyright infringement.

- **Creating the fill pattern - Pattern mode -**

The cell fill patterns to be used when marking a 2D code (QR code/Data Matrix) with laser marker are created.

Cells can be filled, not only in the standard patterns of the marker software (horizontal/vertical), but also in unique patterns.

Use the fill patterns that are created in the "fill pattern" settings in [ID code property] - [Adjust1] tab of marker software.

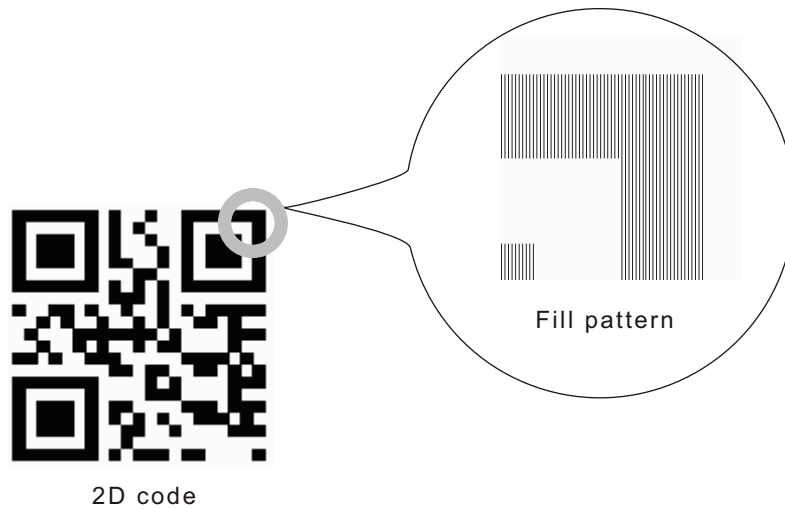

11

- **Creating/editing the logo data - Logo mode -**

Logo data (DXF format) can be loaded to edit the form and the stroke order, and be saved as a logo file for laser marker.

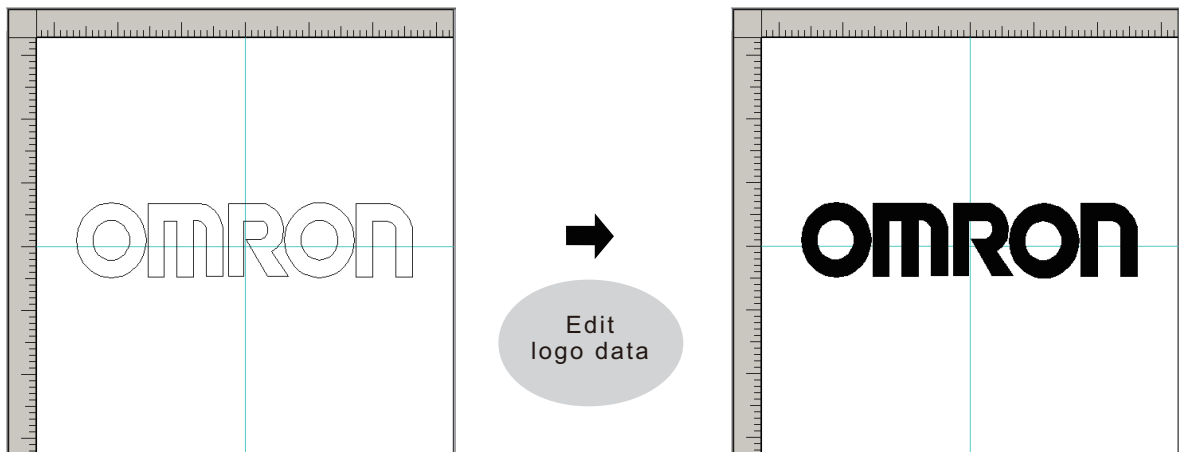

■ **Edit support**

As a supporting function to make creation and editing of data efficient in each mode previously described, you can load and edit existing data or load and reference a model as a draft.

- Load data

The existing data can be loaded and edited.

(Example) Load and edit a text to be referenced from existing "LM Font"

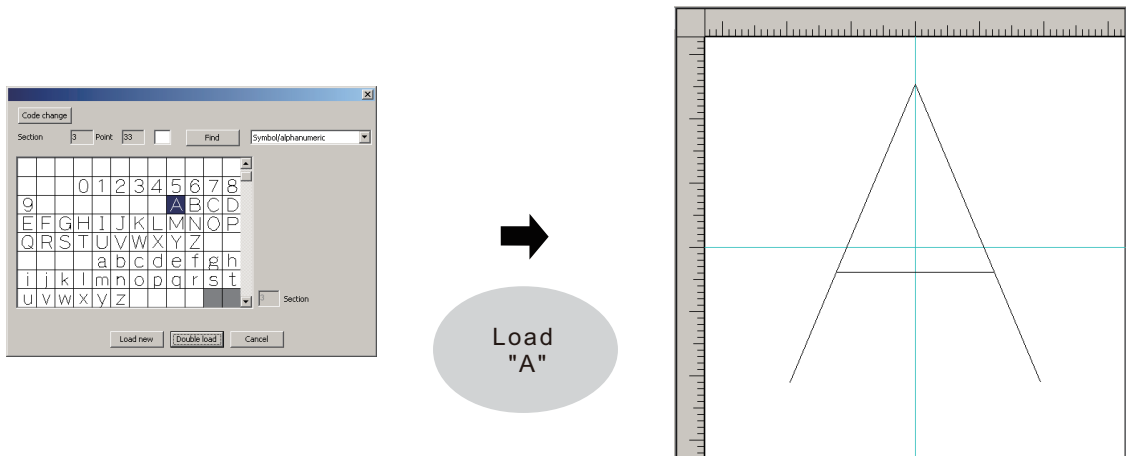

- Load model

You can use a TrueType font or image file as a draft to create/edit text based on that.

(Example) Load a TrueType font as a model, and create text based on that.

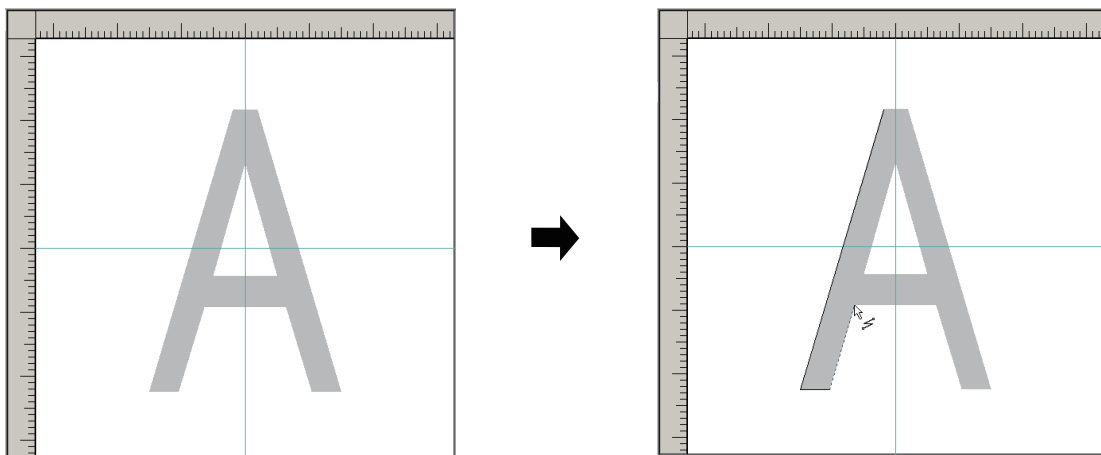

■ Specifying the stroke order

The stroke order of the text or graphic drawn can be changed and/or optimized (Stroke order is automatically set to complete the marking process in the shortest amount of time).

Laser marker applies the marking target to the "single-stroke" information for marking.

The stroke order setting is required to mark the edited content in the optimum time.

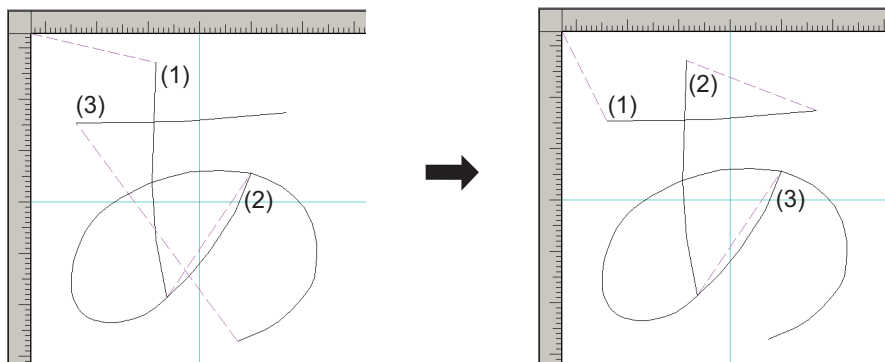

11.2 Starting and Ending Font Logo Editor

Starting the Font Logo Editor

The Font logo editor can be started on its own or from the menu of the offline editing software.

■ When starting the Font logo editor on its own

1 Double-click the Font logo editor shortcut.

The [Select mode] dialog box is displayed.



MX-Z Font Logo Editor

2 Select the operation mode when the Font logo editor is started and click [OK].

The Font logo editor will start with the selected operation mode.

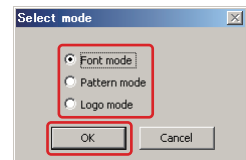

■ When starting from the offline editing software

1 Double-click the offline editing software shortcut, or select Windows's [Start] - [All Programs] - [OMRON] - [MX-Z Series] - [MX-Z Offline Editing Software].

The offline editing software will start.



MX-Z Offline Editing So...

2 Click [Tool] on the menu bar, and then select [Font logo editor].

The [Select mode] dialog box is displayed.

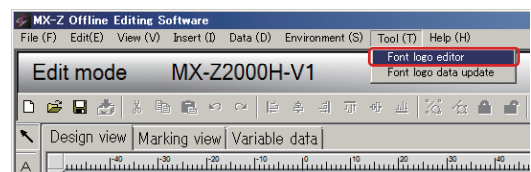

3 Select the operation mode when the Font logo editor is started and click [OK].

The Font logo editor will start with the selected operation mode.

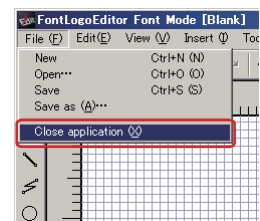

Ending the Font Logo Editor

- 1 Click [File] on the menu bar, and then select [Close application].
The Font logo editor will be closed.

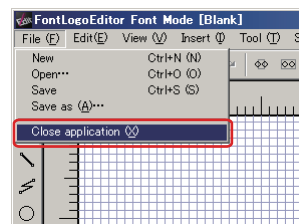

11.3 Screen Configuration and Function of Each Part

This section explains the screen configuration of the Font logo editor and function of each part.

Overall Configuration

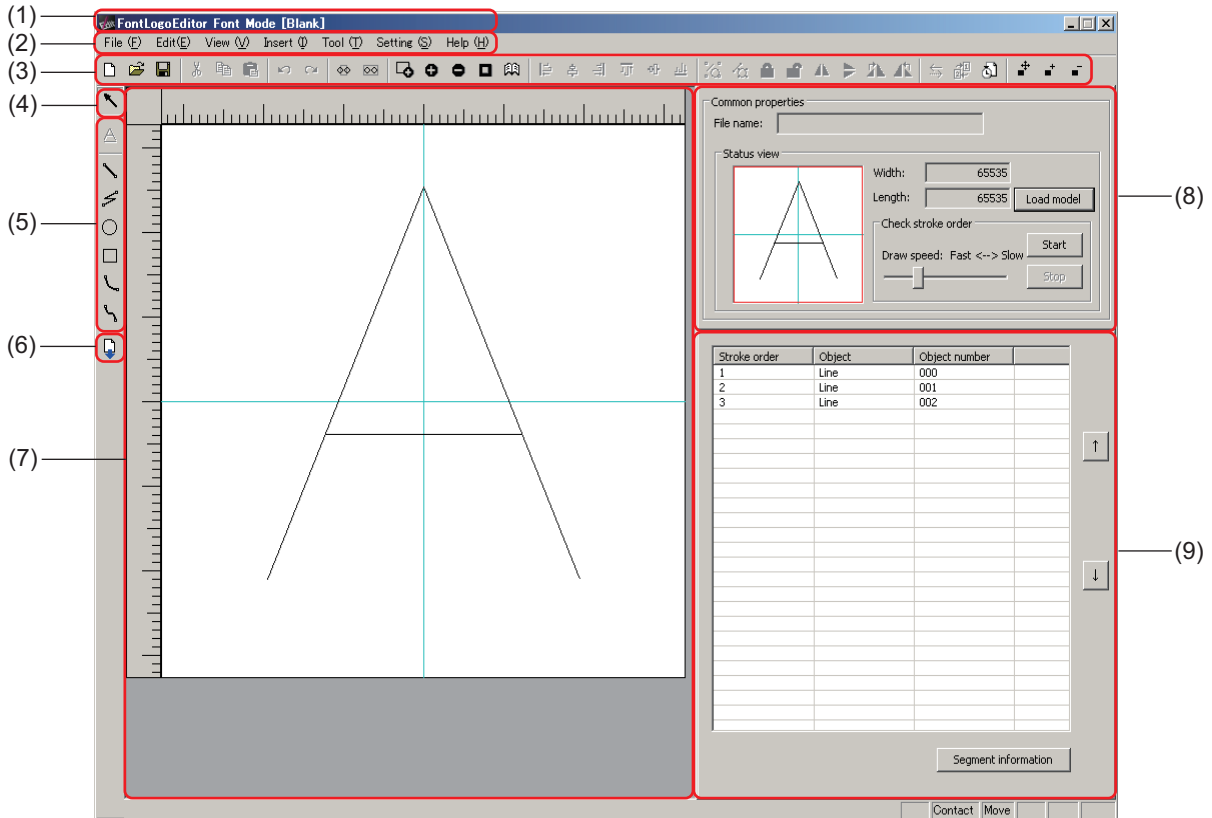

(1) Title bar

The software name (FontLogoEditor), operation mode and file name are displayed in the format shown below.

FontLogoEditor Operation Mode [File Name]



Additional Information

- When logo mode is selected while in operation mode, the Save logo style (file dimension) set in the environment settings will be displayed to the right of the operation mode shown on the title bar.
- For unsaved data, the [File Name] displayed on the title bar will be [Blank].

(2) Menu bar

This is the Font logo editor function menu.



Reference

- "Function of Menu Bar (page 11-12)"

(3) Tool bar

These tools are used to create/edit text/graphic.

The functions that are frequently used from the menu are provided as buttons.



Additional Information

Object

An object is an individual element that makes up a text/graphic that is drawn. For example, the text "A" in the figure below consists of three objects. Note also that an object number is automatically assigned to each object.

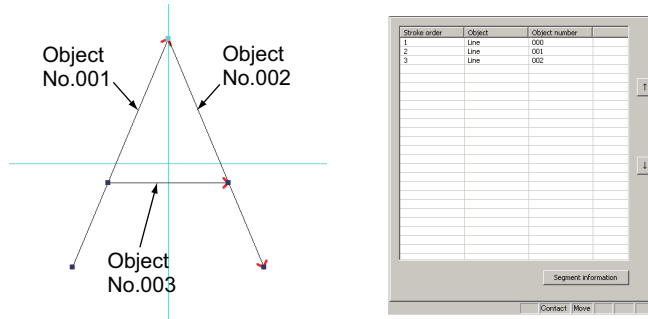

With the Font logo editor, text/graphic deformation and stroke order changes are set for each object. Objects can be connected, grouped or separated.

<If an object is selected>

[Properties] is displayed.

The position, size, angle and the fill of the selected object are displayed/set.

The display content varies depending on whether a single or multiple objects are selected, or whether any of the objects are grouped.

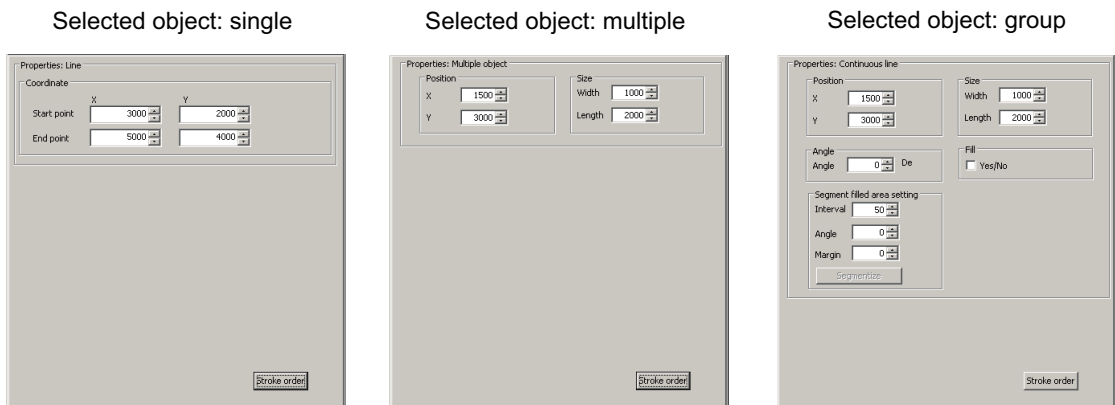

If the selected object is a part of a group, a fill setting can be specified.

• Fill

Specify the grouped object and select the checkbox.

Specify the fill condition using the marker software. (Refer to "♦ Fill setting (page 2-25)"

• Fill segmentation

The fill conditions can be set in details using the Font logo editor.

Specify interval, angle and margin and click [Segmentize]. (Refer to " Fill segmentation (page 11-53)"

To enable line segments, the [Fill] checkbox mentioned above must be selected in advance.



Additional Information

- Make sure that the group to be filled is connected with a continuous line.
- The enclosed regions of the graphic that are odd-numbered are filled from the outside.

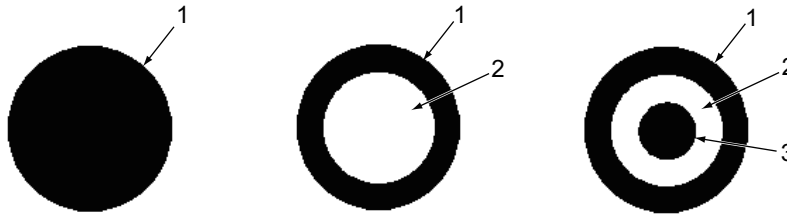

Click [Segment information] to switch the display to the object list and check the stroke order.

<When loading a model>

[Load model] is displayed.

Selects and displays a model file. (Refer to "● Load model (page 11-25)")

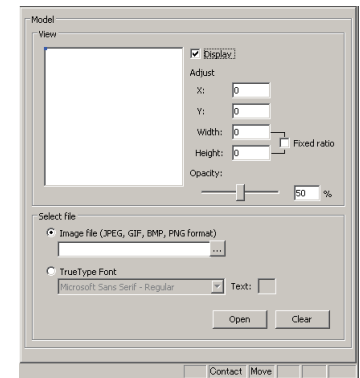

Function of Menu Bar

The following explains the function of each menu on the menu bar.

The functions that are frequently used from the menu can also be performed from the toolbar.

■ [File] menu

Performs file operations.

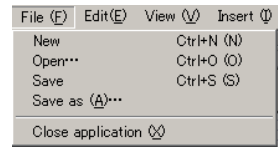

● New (toolbar:)

Creates new data.

Select the operation mode in the [Select mode] dialog box and click [OK].

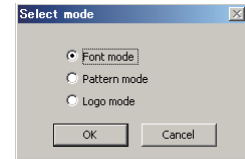

● Open (toolbar:)

Opens the saved data file.

The [Open File] dialog box is displayed for the folder that corresponds to the selected operation mode.

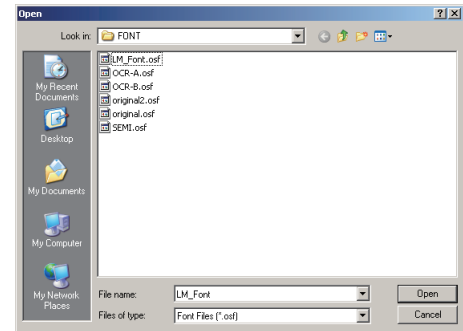

Additional Information

A save confirmation message appears if the data being drawn or displayed has not been saved when [New] or [Open] is selected.

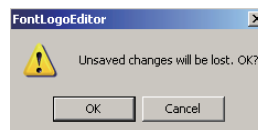

If the data needs to be saved, click [Cancel] and save the data.

● Save (toolbar:)

Saves the data displayed in the drawing area.

● **Save as**

Saves the data currently displayed in the drawing area to a new file.

The [Save as] dialog box is displayed for the folder that corresponds to the selected operation mode.

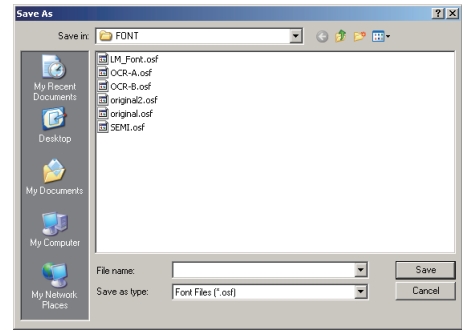

● **Close application**

Ends the Font logo editor.

Click [Yes] to the end confirmation message.

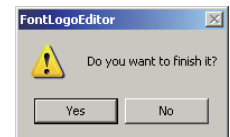

■ **[Edit] menu**

Performs operations to edit the object in the drawing area.

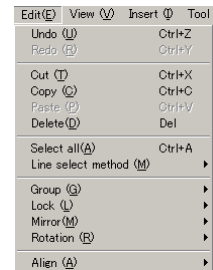

● **Line select method**

Sets one of the following modes when selecting multiple objects.

The setting can be changed at any time.

◆ **Include (toolbar: )**

The object can be selected only when the cursor that is specifying the range is completely enclosing the object.

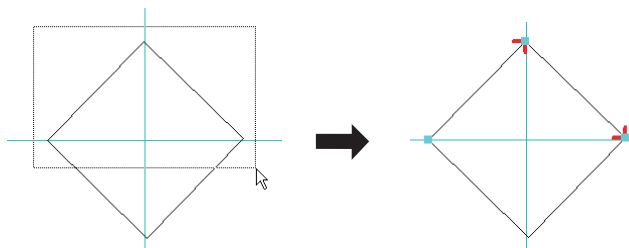

◆ **Contact (toolbar: )**

The object can be selected if the cursor specifying the range is contacting the object even only slightly.

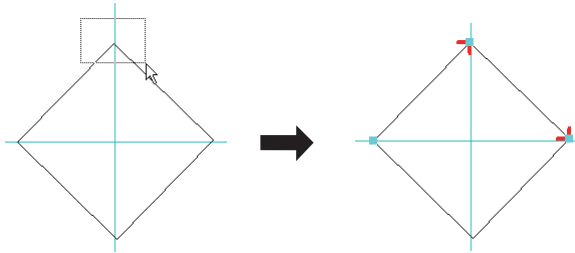

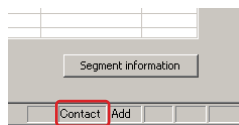

Additional Information

You can check which mode is currently set in the lower-right area of the screen.



● **Group**

◆ **Grouping (toolbar: ) / Ungroup (toolbar: )**

The function and its operations are the same as those of the marker software.



Reference

- "Grouping the Blocks (page 2-10)"

● **Lock**

◆ **Lock (toolbar: ) / Unlock (toolbar: )**

The function and its operations are the same as those of the marker software.





Reference

- "Non-marking Target Setting/Lock Setting (page 5-7)"

- **Mirror** (toolbar:  )

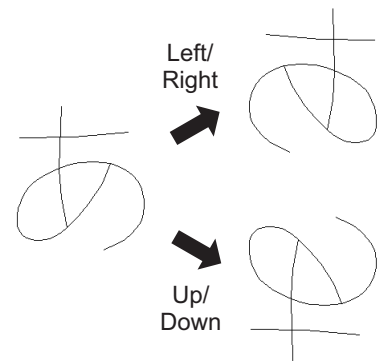
Flips the selected object between left and right or top and bottom.



- **Rotation** (toolbar:  )

Rotates the selected object to the right or left by 90°.

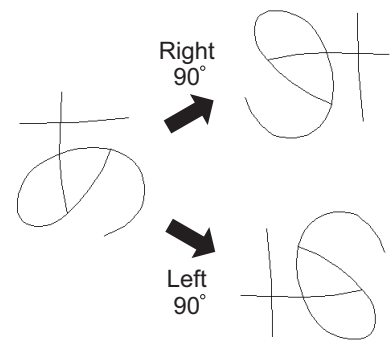

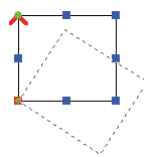

Additional Information

When rotating multiple text or graphic objects at a given angle, group them first, and then click the handle to rotate it in the desired direction. When doing this, the rotational axis is at the lower left coordinate of the group, as shown below.



- **Align**

◆ **Left** (Toolbar: )/**Horizontal center** (Toolbar: )/**Right** (Toolbar: )

Top (Toolbar: )/**Vertical center** (Toolbar: )/**Bottom** (Toolbar: )

The function and its operations are the same as those of the marker software.



Reference

- "Toolbar (page A-7)"

■ **[View] menu**

Performs operations related to the display of an object in the drawing area.

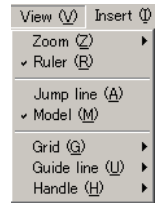

● **Zoom**

◆ **Seamless zoom (toolbar: ) / Zoom in (toolbar: ) /**

Zoom out (toolbar: ) / Fit (toolbar: )

The function and its operations are the same as those of the marker software.



Reference

- "Zoom In/Zoom Out (page 5-2)"

● **Ruler**

The function and its operations are the same as those of the marker software.



Reference

- "Ruler View (page 5-3)"

● **Jump line**

Switches between displaying/hiding the marker moving line during marking.

When set to be displayed, the moving line is displayed in red.

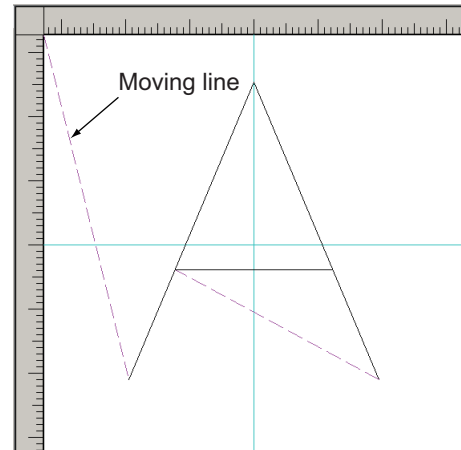

● **Model (toolbar: )**

The [Load model] area is displayed.



Reference

- "● Load model (page 11-25)"

- **Grid**

- ◆ **Display/Snap**

The function and its operations are the same as those of the marker software.



- Reference**

- "Grid View (page 5-3)"
-

- **Guide line**

- ◆ **Display/Add horizontal line/Add vertical line/Delete all/Snap**

The functions and its operations are the same as those of the marker software.



- Reference**

- "Guide Line View (page 5-4)"
-

- **Handle**

- ◆ **Snap**

The function and its operations are the same as those of the marker software.



- Reference**

- "Handle Snap Setting (page 5-6)"
-

■ **[Insert] menu**

Inserts an object onto the drawing area.
 The functions are the same as those of the drawing tool.
 The tool functions and the operations are as follows.

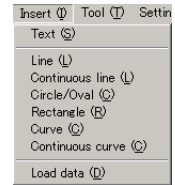

● **Text (enabled for logo mode only)**

Draws a text.
 The text, "abc," with the default settings are displayed by dragging the diagonal line to specify the size of the text.
 When you enter the text to be drawn in [Description] in the selected properties, the entered text will appear.
 This function can be used only in the logo mode.

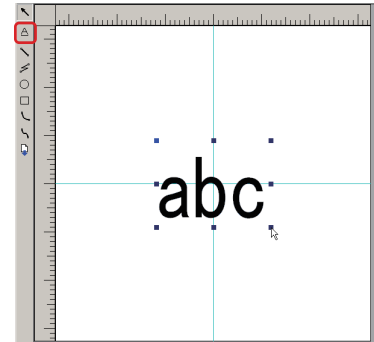

● **Line**

Draws a straight line.
 You can draw a straight line by dragging the cursor from the start point to the end point.

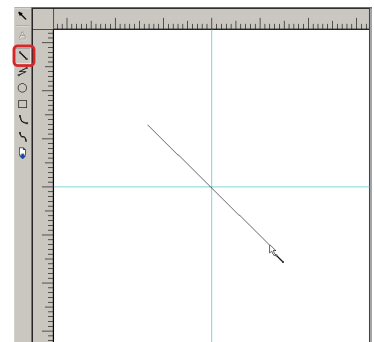

● **Continuous Line**

Draws a continuous line.
 You can draw a continuous line by clicking the start point and the relay points, and double-clicking the end point.

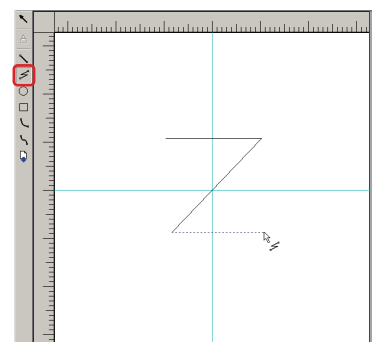

- **Circle/Oval**

Draws a circle/oval.

You can draw a circle/oval by dragging a diagonal line.

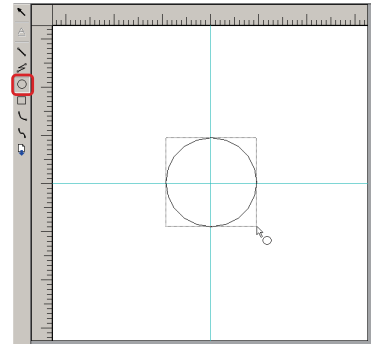

- **Rectangle**

Draws a rectangle.

You can draw a circle/oval by dragging a diagonal line.

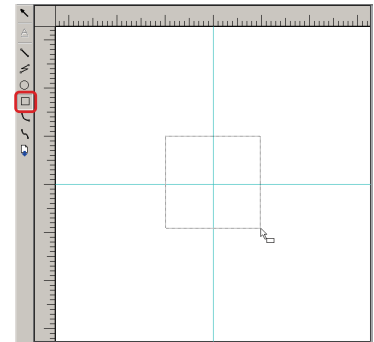

- **Curve**

Draws a curve.

You can draw a curve by dragging the cursor from the start point and clicking the pivot point of the curve and moving it in the direction to bend the mouse cursor to click the end point.

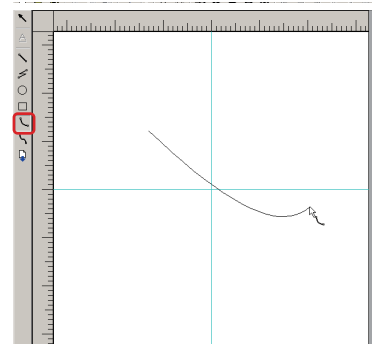

- **Continuous curve**

Draws a continuous curve.

You can draw the first curve by dragging the cursor from the start point and clicking once at the pivot point of the curve, and then moving in the direction of bending the mouse cursor to click the relay point.

Repeat this process to draw a continuous curve.

Double-click the end point.

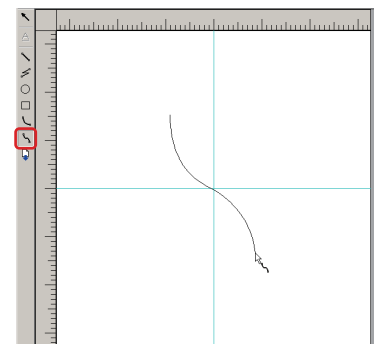

● **Load data**

Loads the data file to be referenced (font, pattern or logo), and the DXF file to the Font logo editor.

You can load data by selecting [Insert] - [Load data] from the menu bar.

The [Open File] dialog box is displayed for the folder that corresponds to the selected operation mode.

The file extension for each operation mode is as follows.

- ""*.osf"": Font file
- ""*.ptn"": Pattern file
- ""*.olg"": Logo (graphic) file
- ""*.dxf"": DXF file

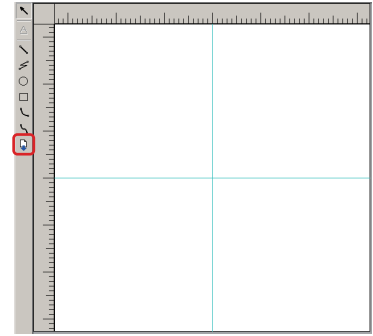

Specify the file to be loaded and click [Open] to display the [Load data] dialog box.

Precautions for Safe Use

If a logo file is created by importing data with a size larger than that of the logo save format ("♦ Save logo style (page 11-28)"), the logo file will be shrunk smaller than the original size, even if you select to reproduce the original size with the graphic block of the laser marker ("♦ Form setting (page 2-103)").

Load data based on the method described below.

Directly select the text/graphic (glyph) to be loaded or enter the text to be loaded in the text box and click [Find] to select the text.

Click [Load new] if clearing the drawing area upon selecting the data and loading new data, and click [Double load] if loading new data in addition to the data currently displayed.

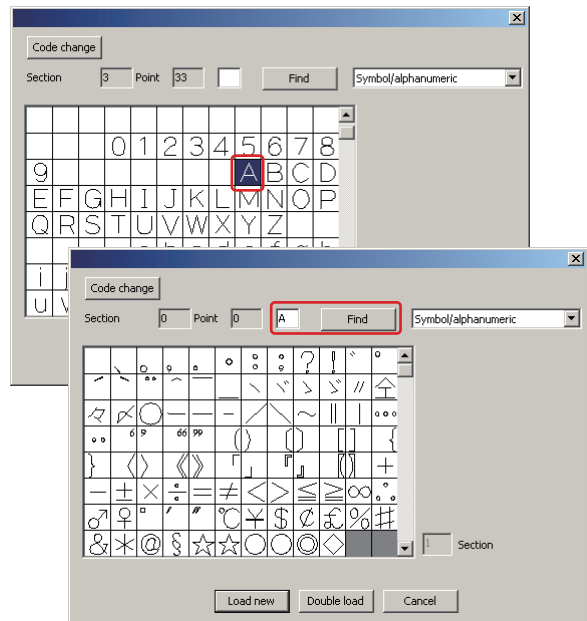



Additional Information

- The data to be displayed can be narrowed down by clicking the list button and selecting the character class.

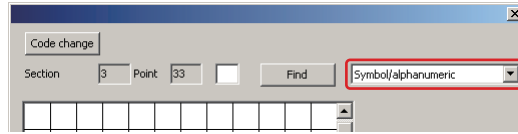

- Once the text is selected, its text code (section, point or Shift-JIS code) is displayed. To switch the display between section, point or Shift-JIS code, click [Code change].

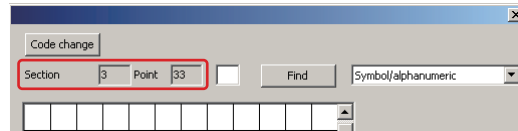

<Pattern mode/logo mode>

Click [Load new] if clearing the drawing area and loading new data, and click [Double load] if loading new data in addition to the data currently displayed.

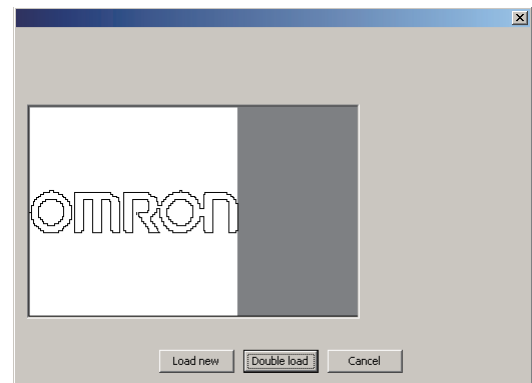

■ [Tool] menu

Performs the edit tool operations on the object in the drawing area.

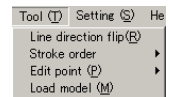

● Line direction flip (toolbar:)

Flips the direction (marking direction) of the segment of the selected object.

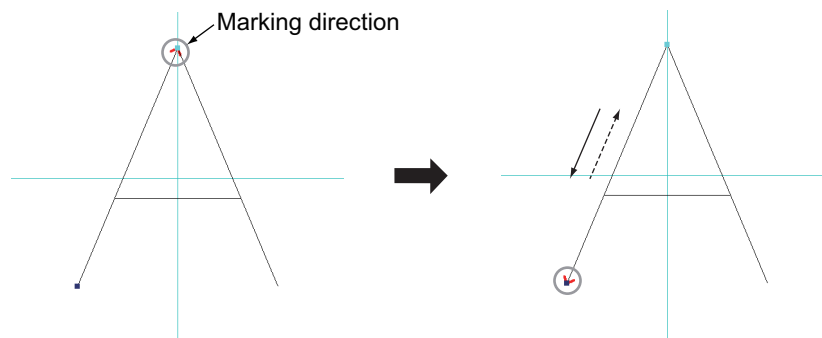

- **Stroke order**

Checks, changes and optimizes the stroke order of the object.

- ◆ **Check**

Checks the stroke order setting.

- **Start**
The drawing area is cleared and the stroke order is traced.
- **Pause**
Stops tracing.
- **Resume**
Resumes the tracing at the point it was stopped.
- **Stop**
Aborts tracing.



Additional Information

- You can check the stroke order via the buttons displayed in [Check stroke order] under [Common properties].

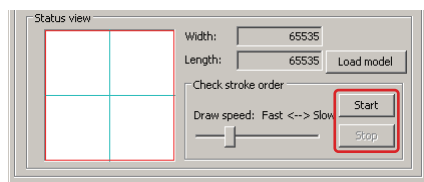

The stroke order can also be checked in the object list.

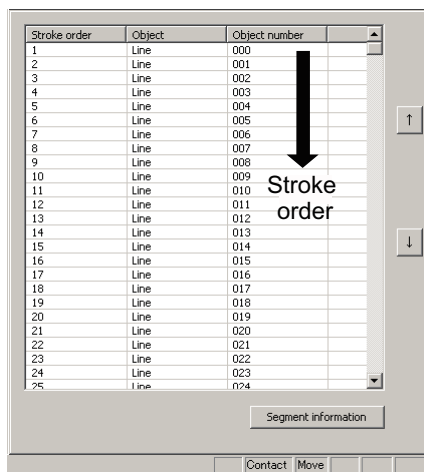

- In [Check stroke order], you can also specify the trace speed using the slide bar.

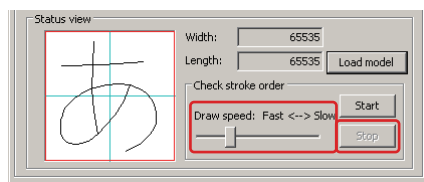

◆ Modify (toolbar:)

To change the stroke order, select the object to be changed and click the icon. And then, select the target object.

You can also change the stroke order in the object list.

Select the object to be changed and click [↑]/[↓].

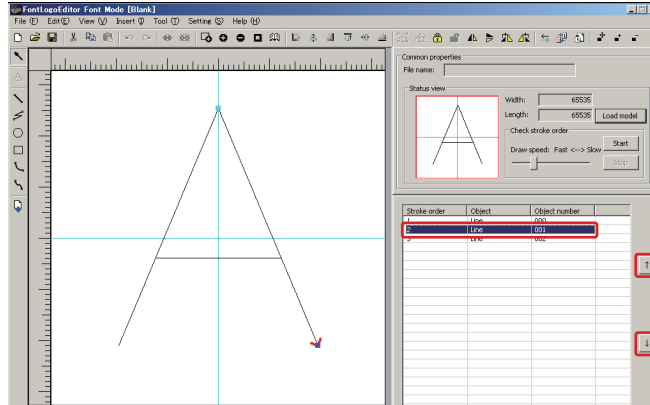

Each time you click it, the selected object slides up/down, changing the stroke order. The modified stroke order can be checked in [Check stroke order].



Additional Information

- When you click [Segment information] with an object selected in the object list, [Properties] that contains information of the selected object, such as its position and size, is displayed.

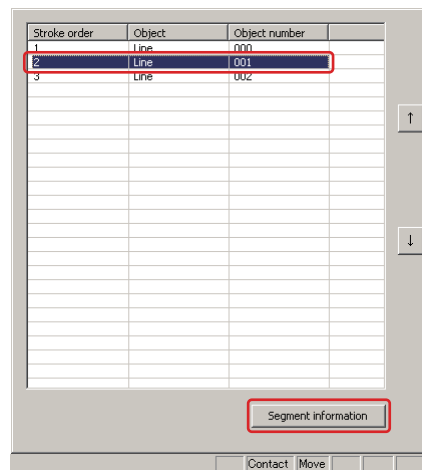

- When objects are grouped, the stroke order is set for the objects that belong to that group.

◆ **Optimization (toolbar: )**

To increase the marking speed, the stroke order is set (optimized) so that marking will be finished in the shortest amount of time.

The optimized stroke order can be checked in [Check stroke order].

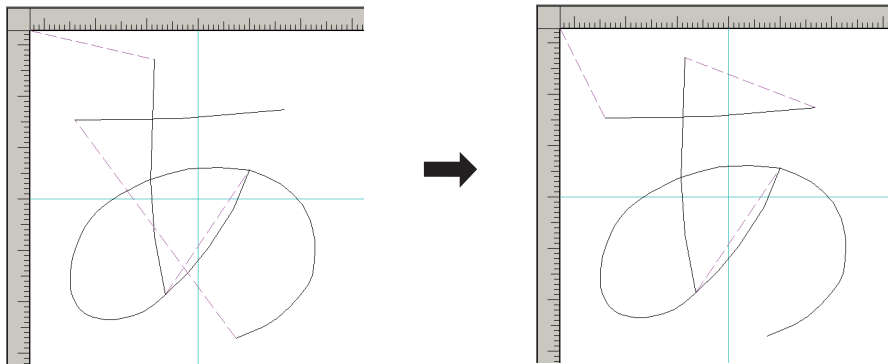

● **Edit point**

You can add relay points to an object or delete added relay points.

◆ **Move (toolbar: )**

Upon specifying an object, click a relay point and drag the mouse.

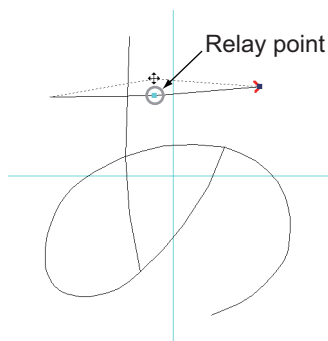

◆ **Add (toolbar: )**

Upon specifying an object and selecting [Add], click the position at which a relay point is to be added.

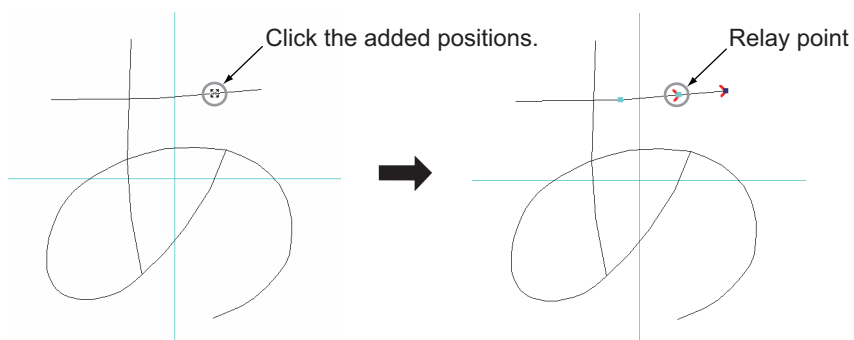

◆ Delete (toolbar:)

Upon specifying an object and selecting [Delete], click the position at which a relay point is to be deleted.

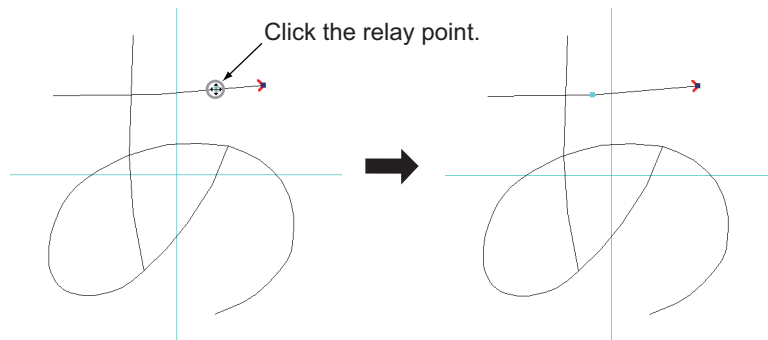

● Load model

[Load model] is displayed.

Selects and displays a model file in this area.

11

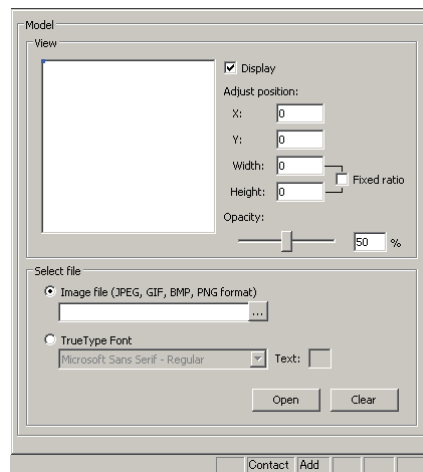

Load model can also be displayed by clicking [Load model] in the [Common properties] area.

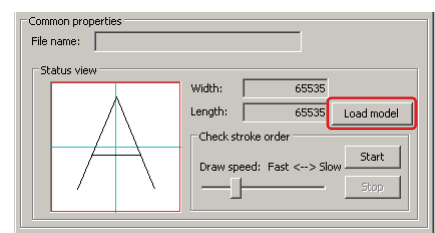

The [Load model] area description is as follows.

<View>

◆ Display

Specifies to display or hide the model.

When hiding the model, clear the [Display] checkbox.

◆ **Adjust position**

X/Y: Sets the X-axis (horizontal) and the Y-axis (vertical) positions of the model.

Note that the X- and Y-axis positions can be adjusted by clicking and moving the model displayed.

Width/Height: Sets the width and the height of the model. To fix the width/height ratio, select the [Fixed ratio] checkbox.

◆ **Opacity**

Specifies the opacity with the slide bar.

Set a high value to display the model darker, and a low value to display it lighter.

<**Select file**>

Selects the image file/TrueType Font file from which the model is to be displayed.



Additional Information

Only JPEG, GIF, BMP, and PNG files can be loaded as a model file.

■ **[Setting] menu**

Specifies the default display settings and tool settings.

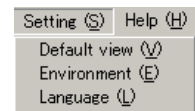

● **Default view**

The [Default view setting] dialog box is displayed.

Specifies the display-related default settings in this dialog box.

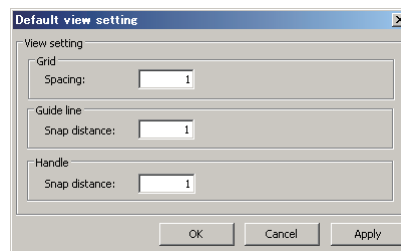

◆ **Grid: Spacing**

Sets the grid spacing.

◆ **Guide line: Snap distance**

Sets the maximum interval when snapping an object to a guide line.

The object snaps when the distance between the object and the guide line is smaller than the value set here.

◆ **Handle: Snap distance**

Sets the maximum interval when snapping one object to the closest object's handle when there are multiple objects.

The object snaps when the interval between the objects is smaller than the value set here.



Additional Information

Set value of guideline and handle

The set value of snap distance for the [Guide line] and the [Handle] is based on the ruler scale. Specify the setting based on the figure below as a reference.

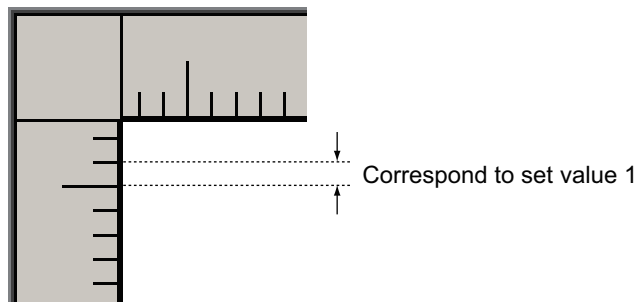

● Environment

The [Environment setting] dialog box is displayed.

Specifies the display-related environment settings in this dialog box.

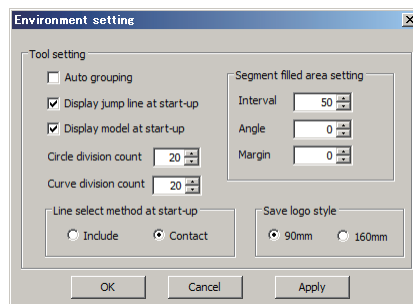

◆ Auto grouping

This checkbox is selected when drawing and also grouping "circles/ovals" or "rectangles" at the same time.

◆ Display jump line at start-up

This checkbox is selected to enable [View] - [Jump line] on the menu bar when the Font logo editor is started. (Refer to "● Jump line (page 11-16)")

The Font logo editor will start up with [View] - [Jump line] on the menu bar selected.

◆ Display model at start-up

This checkbox is selected to enable [Display] in [Load model] when the Font logo editor is started. (Refer to "● Load model (page 11-25)")

The Font logo editor will start up with [View] - [Model] on the menu bar selected.

◆ Circle division count/Curve division count

Sets the division count (number of objects) when drawing circles/curves.

The higher the division count is, the smoother the curved line will be.

◆ Line select method at start-up

Specifies the default settings for object selection method (Include/Contact). (Refer to "● Line select method (page 11-13)").

◆ Segment filled area setting

Sets the initial value of each item (interval, angle and margin) for fill line segments. (Refer to " Fill segmentation (page 11-53)").

◆ Save logo style

Select a dimension format of the logo as: either 90mm (square) or 160mm (square). The selected dimension format will appear in the title bar.

● Language

The [Language setting] dialog box is displayed.

Sets the Font logo editor display language in this dialog box.



Reference

- "6.6 Language Setting (page 6-15)"
-

■ [Help] menu

Displays the Font logo editor help and version information.

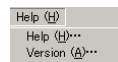

11.4 Creating Font

This section explains the basic procedure of font creation based on the following examples.

- Example 1: Draw a text and save it as a new font file and,
- Example 2: Load a model, draw (edit) a text based on the model and save to an existing font file

Precautions for Correct Use

Fonts can be saved only in S-JIS format with this function.

Example 1 - Drawing and Saving New Text -

■ Creating content

Draw the text "A" and save it as a glyph of a new font file, "FontA.osf."
Specify Shift-JIS code, "8260," in the save target.

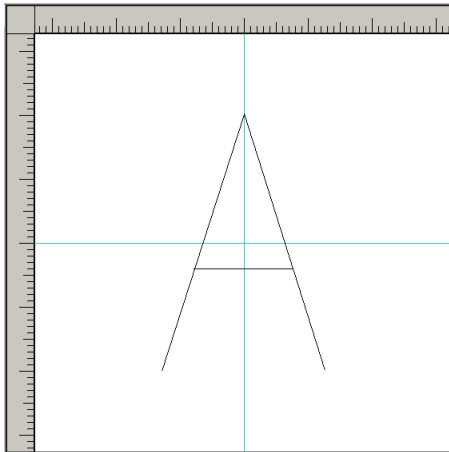

Draw "A"

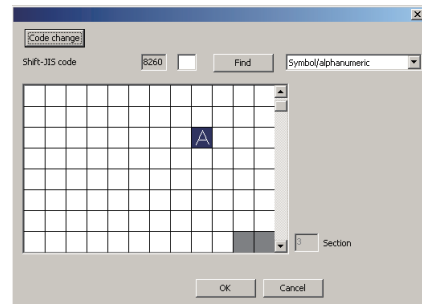

Save new font file

Additional Information

Glyph

A glyph is an element that makes up a font, and represents the individual character image of a font (file) here. A group of glyphs is a font.

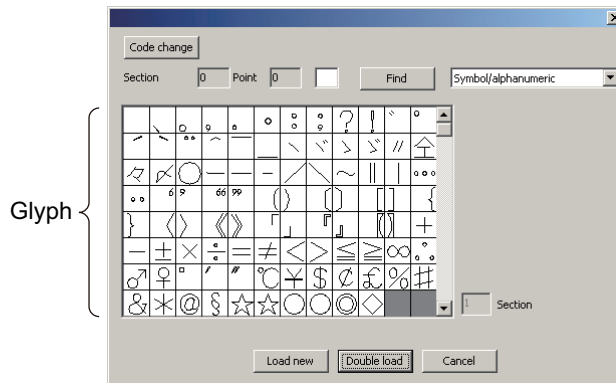

Reference

- "A.5 Shift-JIS Code Table (page A-13)"

■ Creating procedure

● Drawing of text

- 1 Click [File] on the menu bar, and then select [New].
The [Select mode] dialog box is displayed.

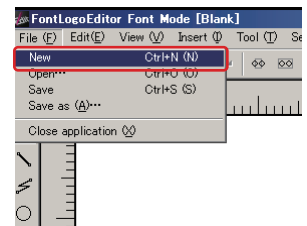

Additional Information

When data is being drawn or displayed, the save confirmation message will appear. Click [OK] or [Cancel].

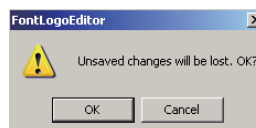

- 2 Select [Font mode] and click [OK].
The Font logo editor will be on the font mode.

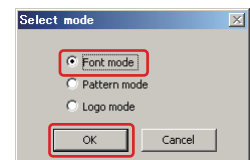

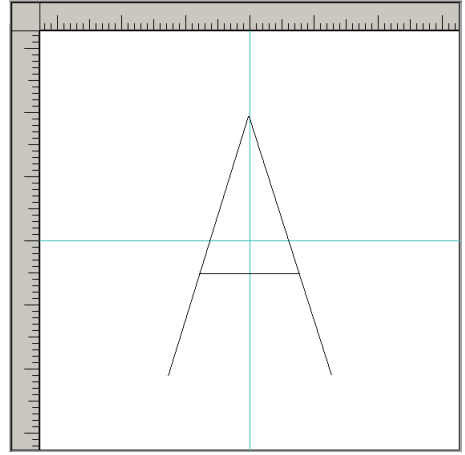
3 Use the drawing tool to draw the text "A."



Additional Information

- Make sure that any part of the text or graphic does not go outside of the drawing area. If a part of it is outside of the area, that portion will not be marked.
- Be sure to align at the bottom when registering multiple texts or graphics. Display a guide line at the bottom edge in advance and draw a text or graphic aligning the bottom edge to the guide line. (Refer to "● Guide line (page 11-17)")

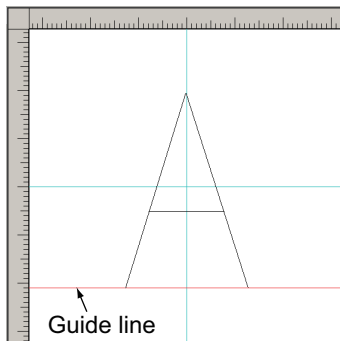

- 4 Click [Common properties] - [Check stroke order], and then [Start] to check the stroke order.
If necessary, click [Stroke order optimization] on the toolbar to optimize the stroke order.**

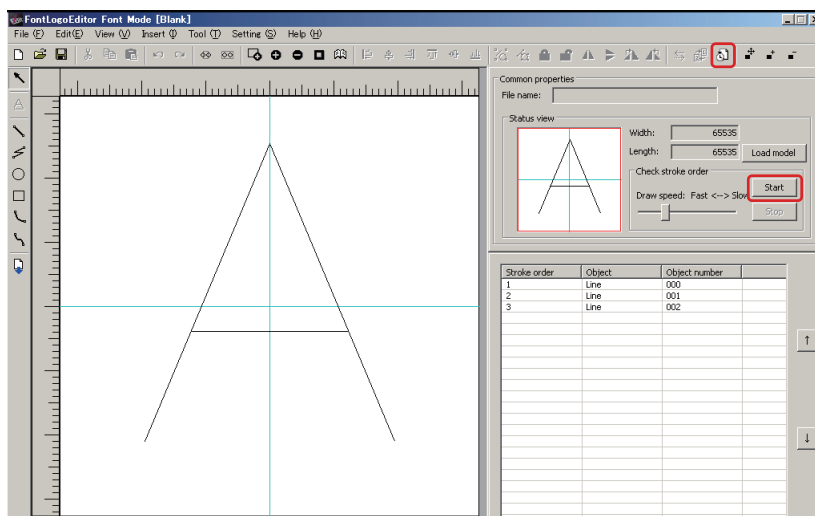



Additional Information

- The basic stroke order should be from left to right as shown in the figure below.

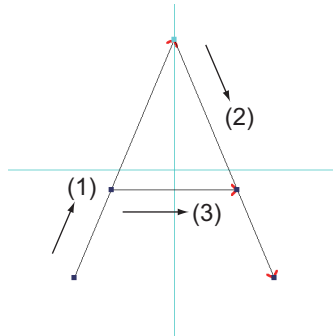

- The stroke order can be manually changed by the following method, if necessary.
 - Seg dir flip (Refer to "● Line direction flip (page 11-21)")
 - Chg ord (Refer to "● Modify (page 11-23)")
 After changing the stroke order, be sure to check it.

● Saving new fonts

1 Click [File] on the menu bar, and then select [Save as].

The [Save as] dialog box is displayed and the content of the [Font] folder is displayed.

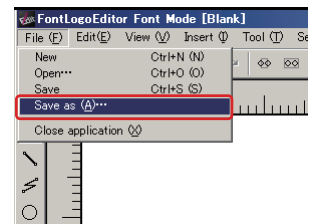

2 Enter a new file name, "FontA" in [File name] and click [Save].

The [Load data] dialog box is displayed.

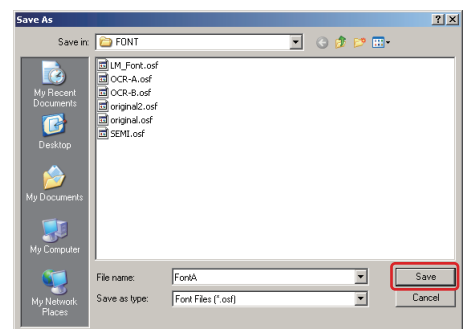

- 3 Click [Code change] and switch from the "Section" display to the "Shift-JIS code" display.

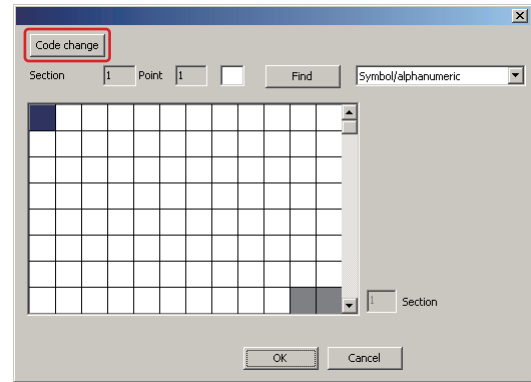

- 4 Enter "A" in the center text box, then click [Find].
"8260" will be displayed in the [Shift-JIS code] box.

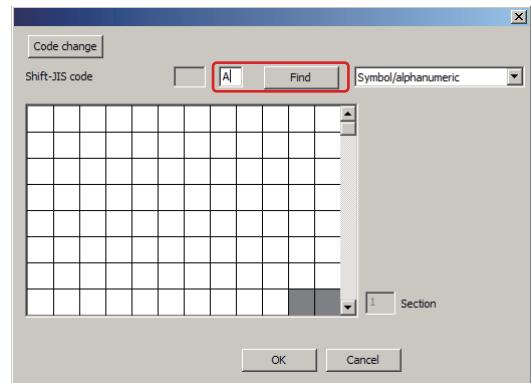

- 5 Click [OK].
The text created will be saved to the glyph of Shift-JIS code "8260."

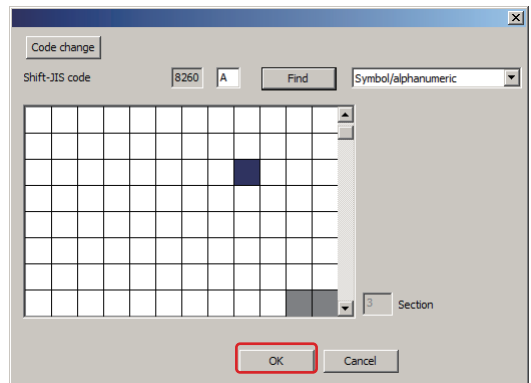

Additional Information

To register other texts, repeat the steps 1 and on in "Drawing of text" (Refer to "● Drawing of text (page 11-30)") and overwrite the "FontA.osf" file.

Example 2 - Drawing a Text Based on a Model/Saving to an Existing Font File -

■ Creating content

Upon loading the text "A" in the "Microsoft Sans Serif" font file as a model, load and edit the text image of glyph "A" in the existing "LM_font.osf" font file, and overwrite it to the "LM_font.osf" font file.

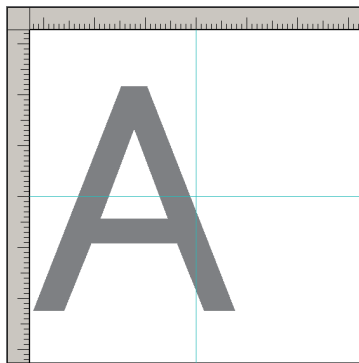

Load
model

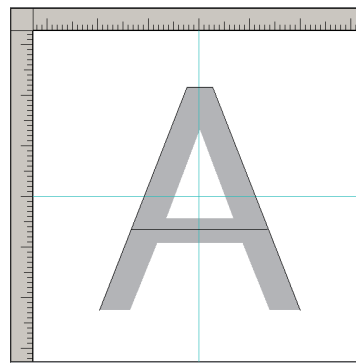

Load "A" from
existing font
and edit

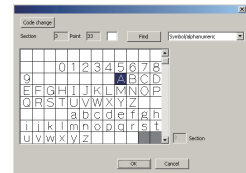

Save

11

■ Creating procedure

● Loading the model

- 1 Click [Load model] in the [Common properties] area.

The [Load model] area is displayed.

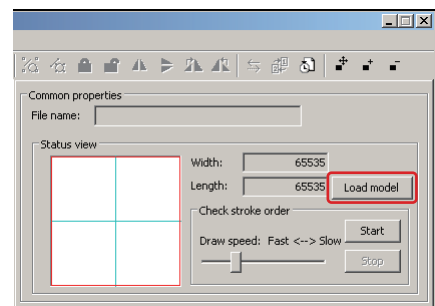

- 2 Select the [Display] check box.

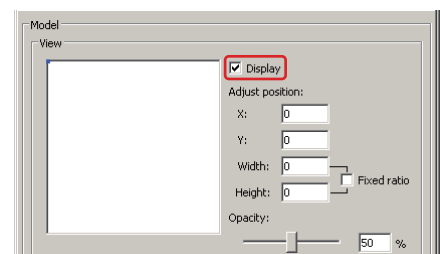

- 3 Select [TrueType Font] under [Select file] and click the list button to select "Microsoft Sans Serif - Regular."

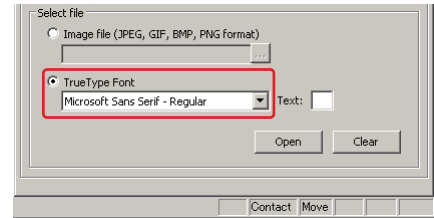

- 4 Enter the model text "A" in [Text], and click [Open].

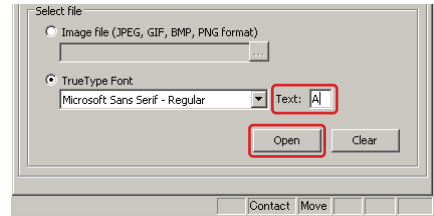

The text will be displayed as a model in the drawing area using the selected font.

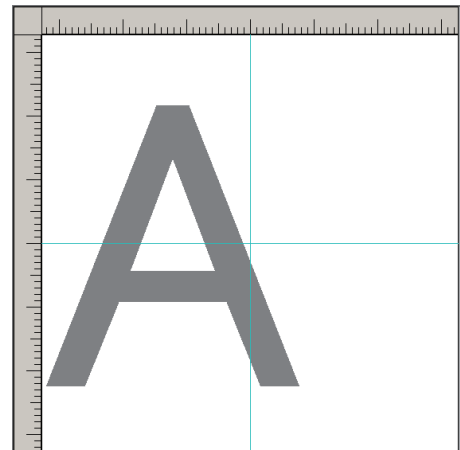

The model position is also displayed in [View].

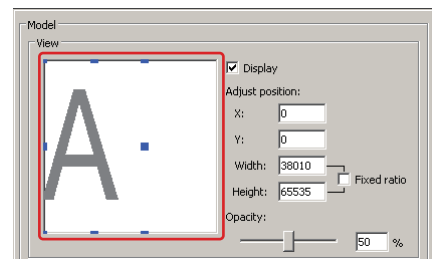

Additional Information

- To temporarily hide the model, select [View] from the menu bar and clear the checkbox for [Model].
- Click [Clear] to clear the displayed model.

- 5 Set the model position, size and opacity in [View].**
If the object is too hard to see, enter a small value for opacity.

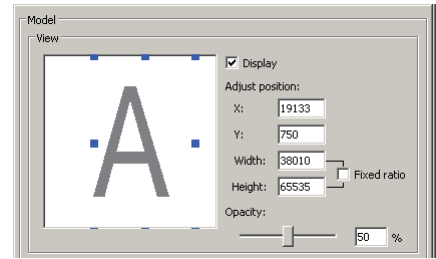

● **Loading a glyph from an existing font file**

 **Precautions for Correct Use**

- Browse existing font files in the following folder.
C:\OMRON\MX-Z Offline Editing Software\Bin\Font
Do not save or delete the font file.

- 1 Click the [Load data] tool.**
The [Open File] dialog box is displayed.

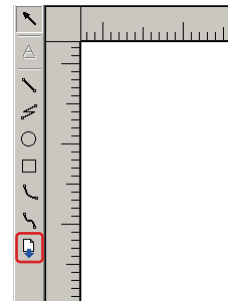

- 2 Select "LM_Font.osf" and click [Open].**
The [Load data] dialog box is displayed.

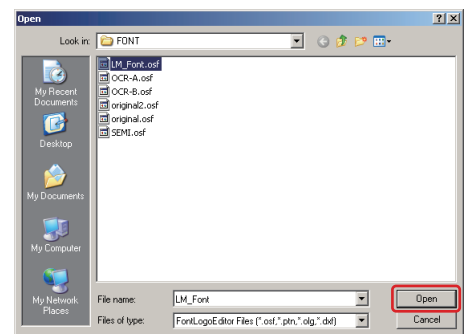

3 Select the glyph, "A" and click [Load new].

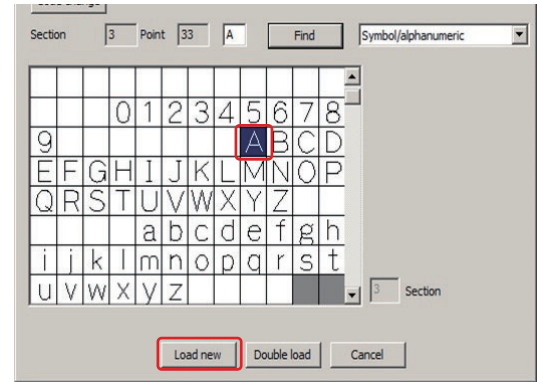

The "LM_Font.osf" glyph, "A," will be loaded and displayed in the drawing area.

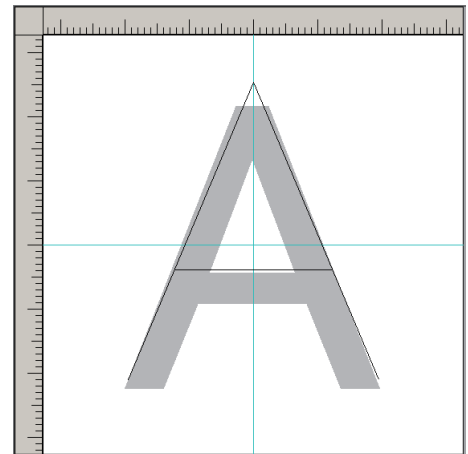

● **Editing the text image**

1 Edit the text image with the tools using the model as a draft.

(Example) When smoothing out the upper edge of the text "A" and align the graphic to the outline of the model

[1] Click [Seamless zoom] on the toolbar, and then expand the upper edge of the text "A."

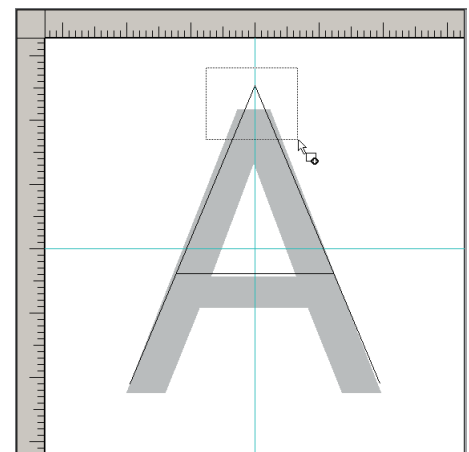
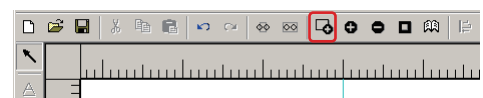

- [2] Click [Add point] on the toolbar, and add a point at both left and right positions on the upper edge.

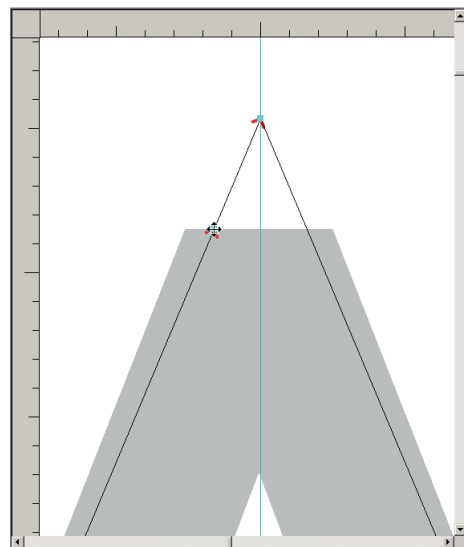

11

- [3] Click [Delete point] on the toolbar and click the tip of the text to delete the point.

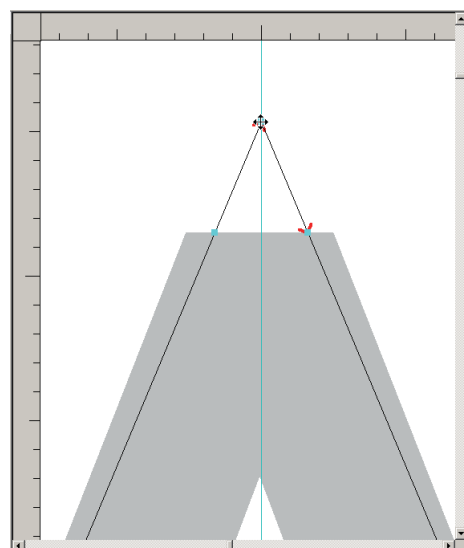

- [4] Specify the object and align the upper edge of the text "A" to the model (2 positions on the left and right).

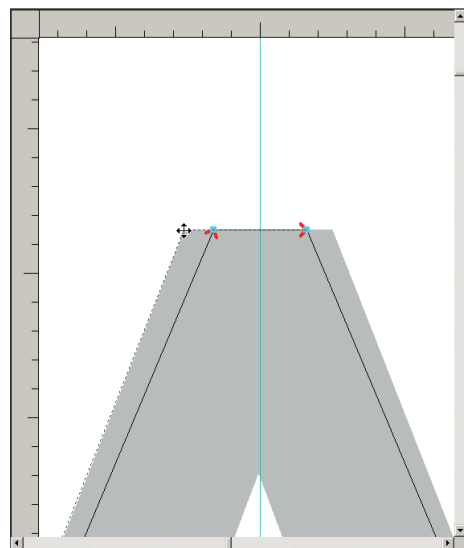

[5] Upon clicking [Fit] on the toolbar, click [Seamless zoom], and expand the bottom edge of the text "A."

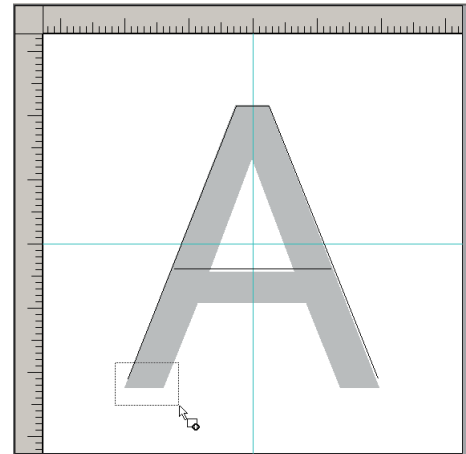
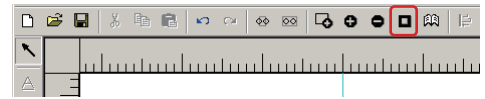

[6] Align the bottom edge of the text "A" to the model (2 positions on the left and right).

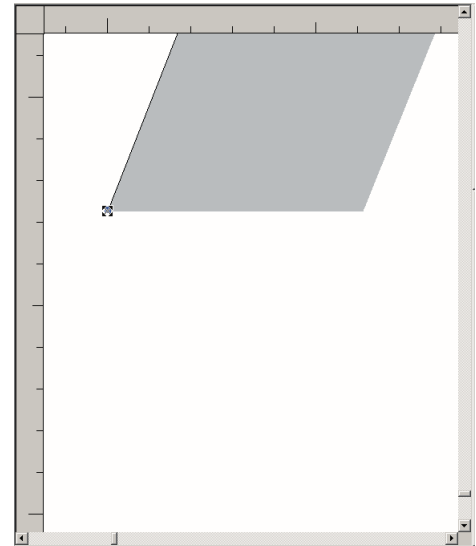

[7] Upon clicking [Fit] on the toolbar, align the center line of the text "A" to the center of the model and adjust the length.

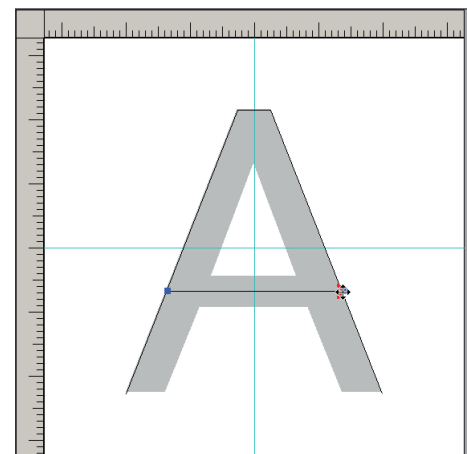

- 2** Click [Common properties] - [Check stroke order], and then [Start] to check the stroke order.
If necessary, click [Stroke order optimization] on the toolbar to optimize the stroke order.

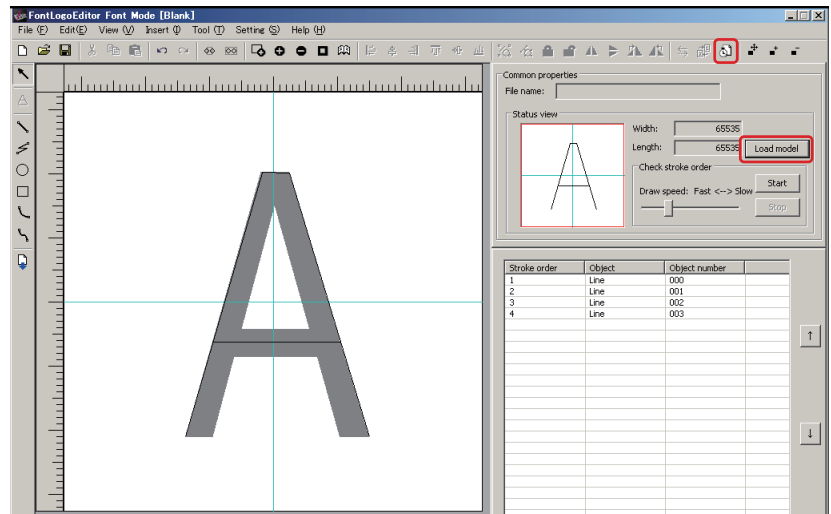

11

● **Saving to the existing font file**

- 1** Click [File] on the menu bar, and then select [Save as].
The [Save as] dialog box is displayed and the content of the [Font] folder is displayed.

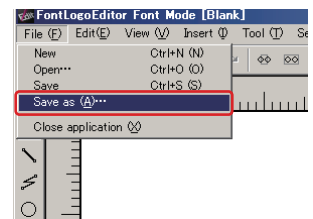

- 2** Select the existing font file, "LM_Font.osf" and click [Save].
An overwrite confirmation message is displayed.

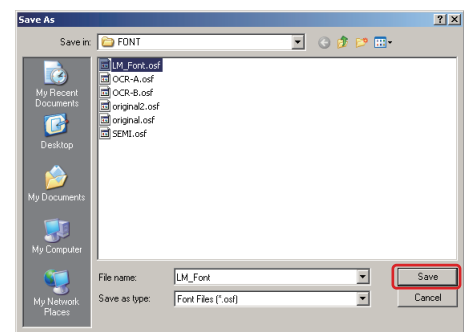

- 3** Click [Yes].
The [Load data] dialog box is displayed.

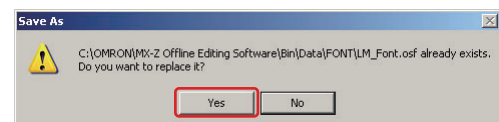

- 4 Specify the save location and click [OK].**
If the data has been loaded, the location of the loaded text is specified as the default position.

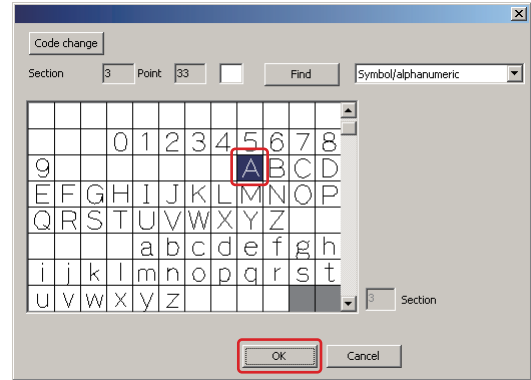

Glyph "A" of "LM_Font.osf" will be replaced by the text image drawn, and will be saved.

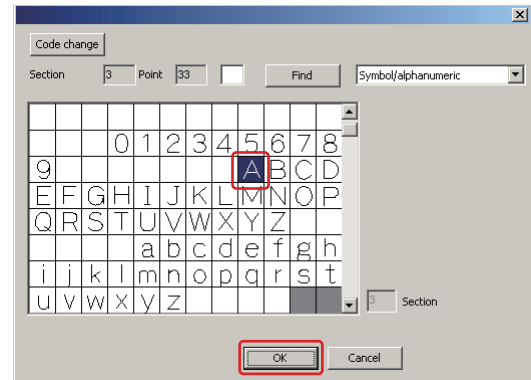

11.5 Creating Fill Pattern

This section explains how to create a diagonal line fill pattern as an example of creating fill patterns.

Example - Create a Spiral-shaped Fill Pattern -

- 1 Click [File] on the menu bar, and then select [New].
The [Select mode] dialog box is displayed.

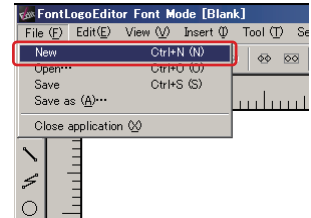

Additional Information

When data is being drawn or displayed, the save confirmation message will appear. Click [OK] or [Cancel].

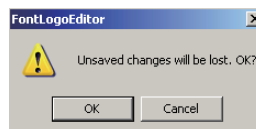

- 2 Select [Pattern mode] and click [OK].
The Font logo editor will be the pattern mode.

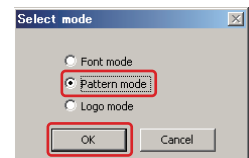

- 3 Draw a fill pattern using the [Continuous Line] tool.

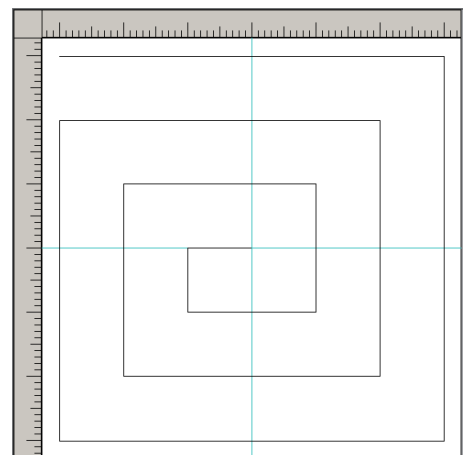

Additional Information

Data can be loaded also to draw a fill pattern. The method of loading data is the same as that in the font mode. (Refer to "● Loading the model (page 11-35)")

- 4 Click [Common properties] - [Check stroke order], and then [Start] to check the stroke order.

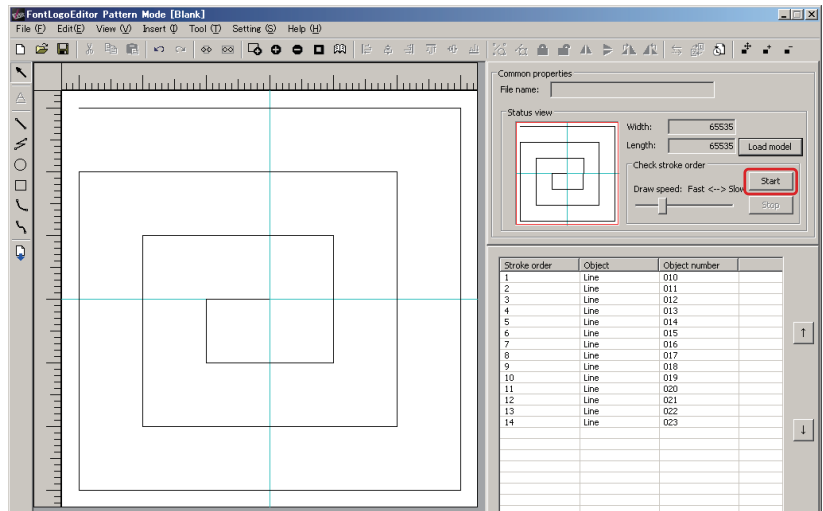

- 5 Click [File] on the menu bar, select [Save]/[Save as], and save the fill pattern drawn.

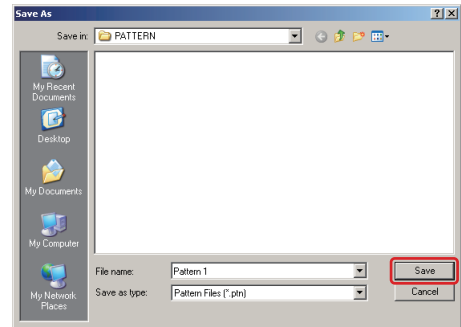

11.6 Creating Logo

This section explains how to edit a logo by loading and filling DXF data as a logo creation procedure.

Example

■ Creating content

Load the "OMRON" logo (DXF file), edit the text "R" (change the upper-right graphic to a right angled corner) and fill it, and then save it as new logo data.

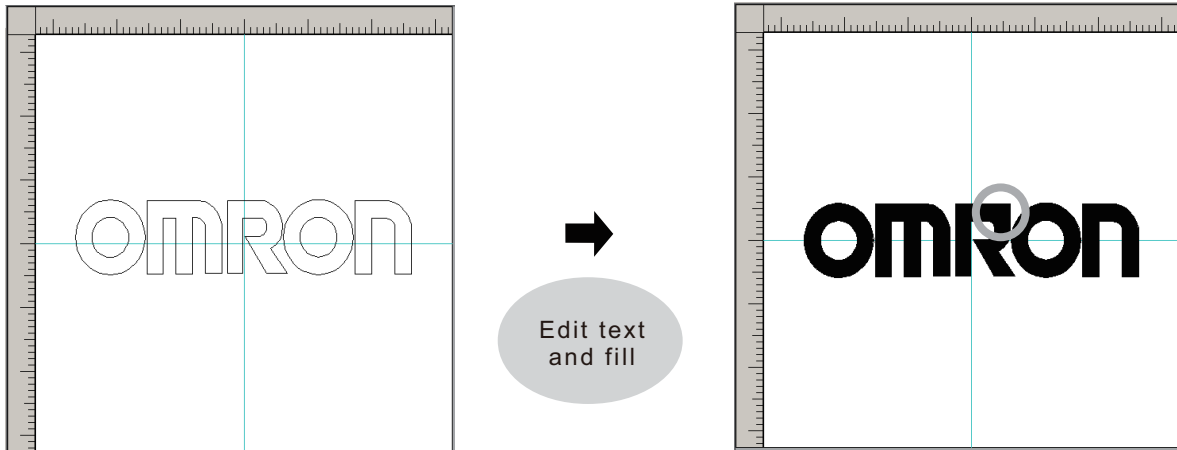

■ Creating procedure

● Loading the logo data

- 1 Click [File] on the menu bar, and then select [New].
The [Select mode] dialog box is displayed.

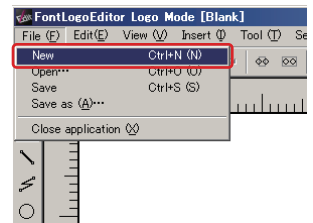

Additional Information

When data is being drawn or displayed, the save confirmation message will appear. Click [OK] or [Cancel].

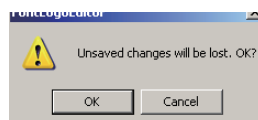

- 2 Select [Logo mode] and click [OK].
The Font logo editor will be the logo mode.

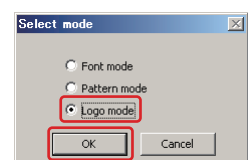

- 3 Click the [Load data] tool.
The [Open] dialog box is displayed.

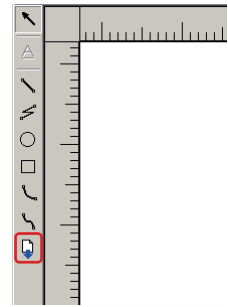

- 4 Select the DXF file, "omron" and click [Open].
The [Load data] dialog box is displayed.

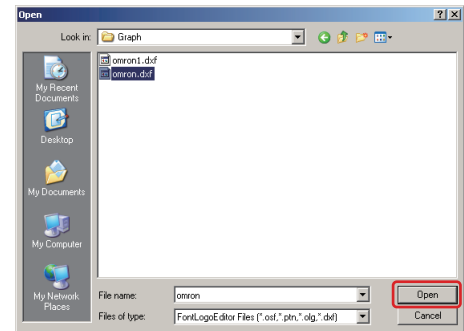

- 5 Click [Load new].
The "OMRON" logo is displayed in the drawing area.

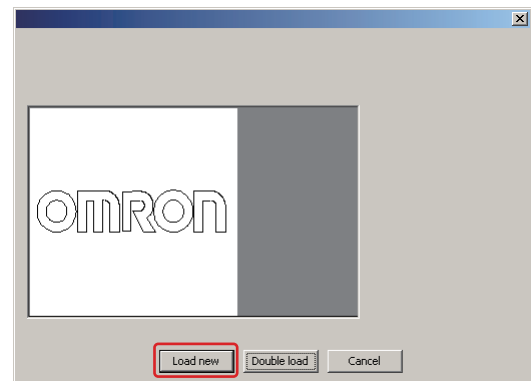

- Editing the text "R"

- 1 Click [Seamless zoom] on the toolbar, and specify the text "R" in a range and expand it.

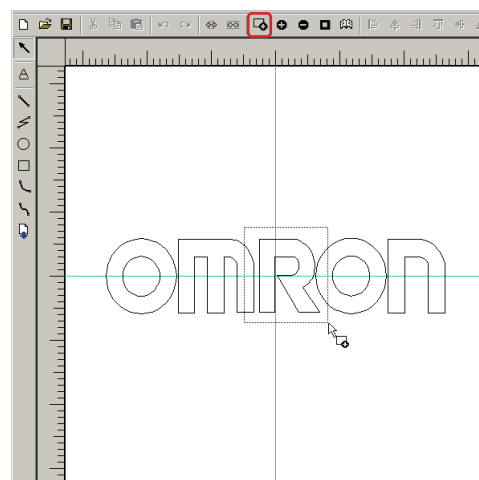

11

- 2 Click [View] on the menu bar, select [Guide line] to display horizontal and vertical lines, and place them on the edit positions.

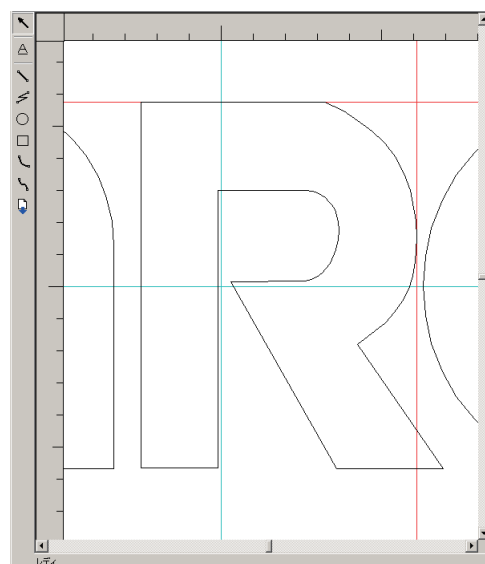

3 Specify the editing range.

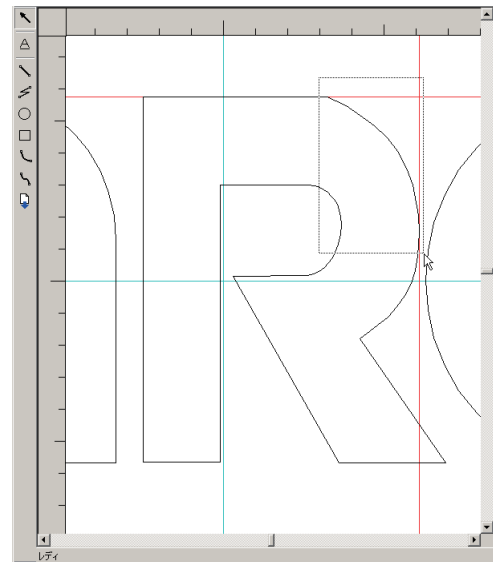

Additional Information

If the [Auto grouping] checkbox is selected in the [Environment setting] dialog box (Refer to "● Environment (page 11-27)"), the loaded data will be grouped. To edit the points, ungroup the data first.

4 Click [Delete point] on the toolbar and click the relay point in the editing range to delete the point.

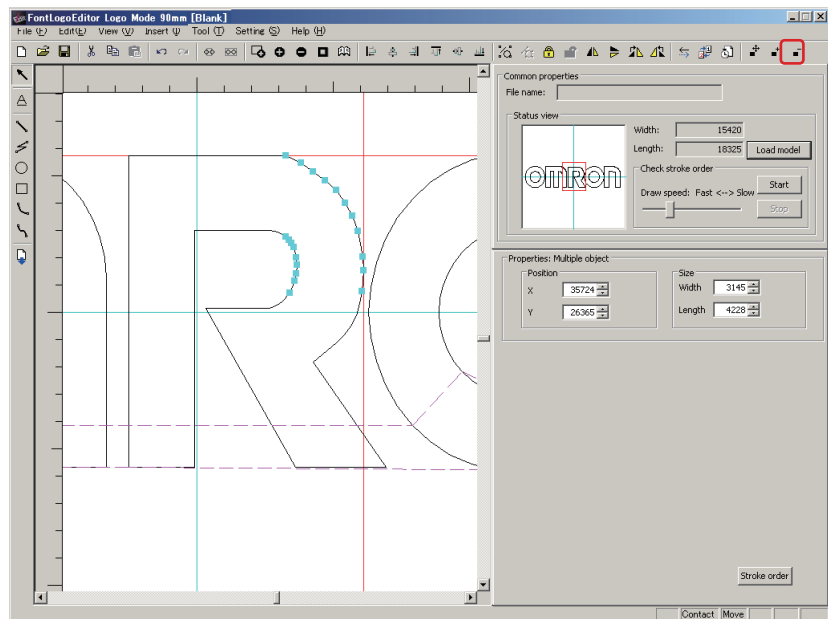

5 Click [Add point] on the toolbar and add a relay point.

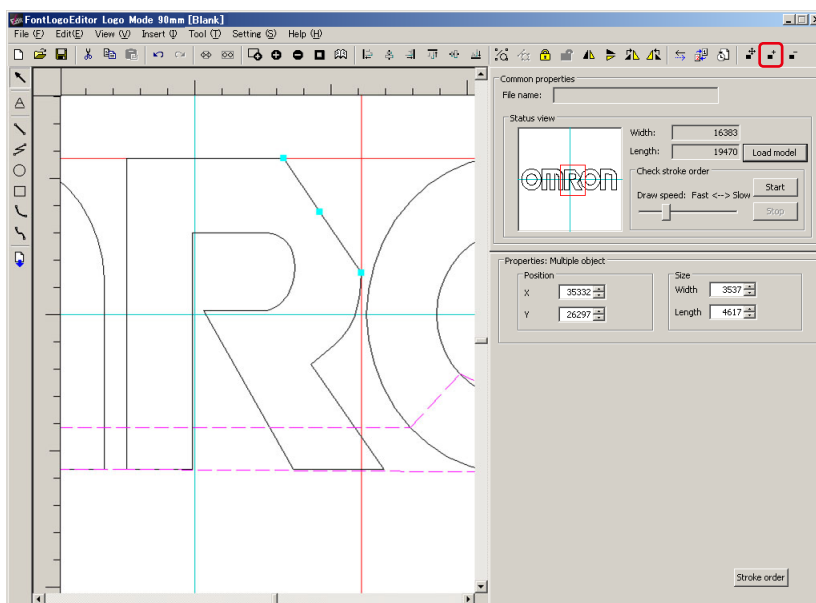

11

6 Move the added relay point according to the guide line.

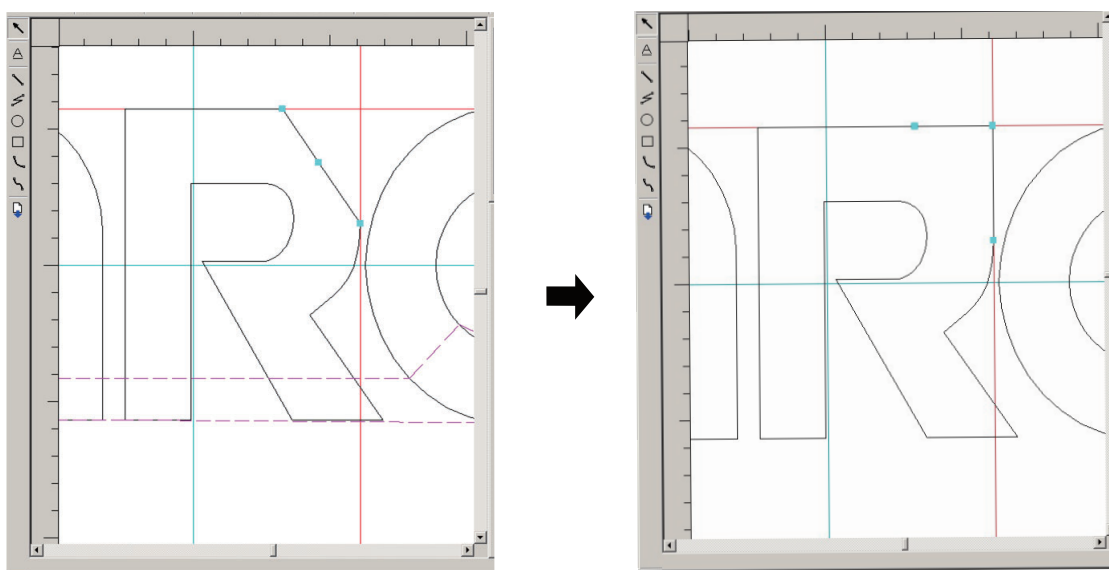

● Filling the text

1 Select the text "R."

If the object selection method is set to "Contact" specify the boundary of texts "R" and "O" to select the only text "R."

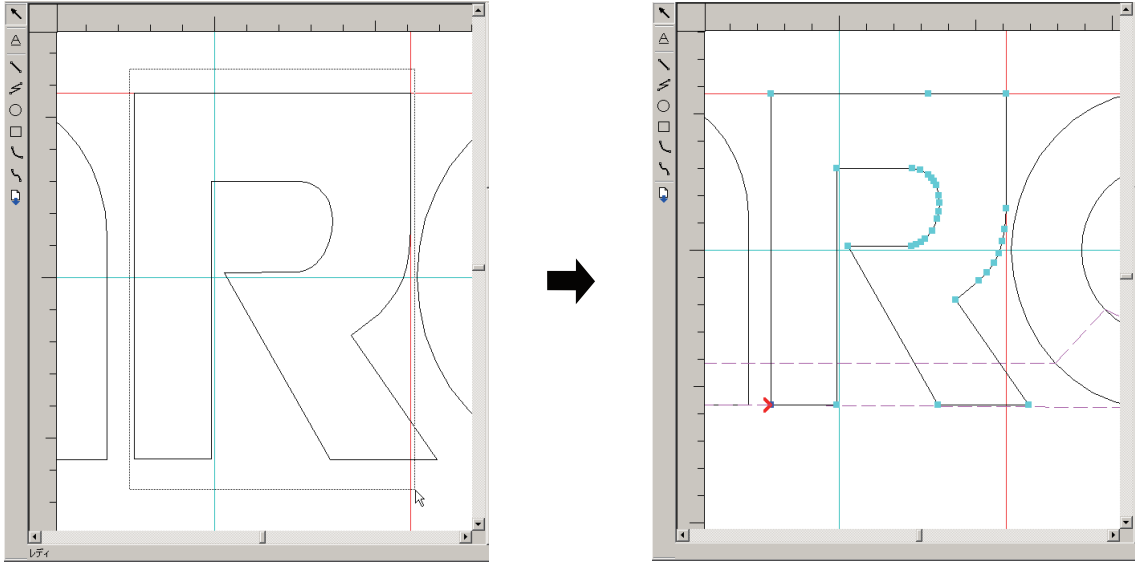

If the object selection method is set to "Include" a portion of the text "O" gets included when the text "R" is selected. Click the object while holding down the [Ctrl] key and delete the points for the text "O."

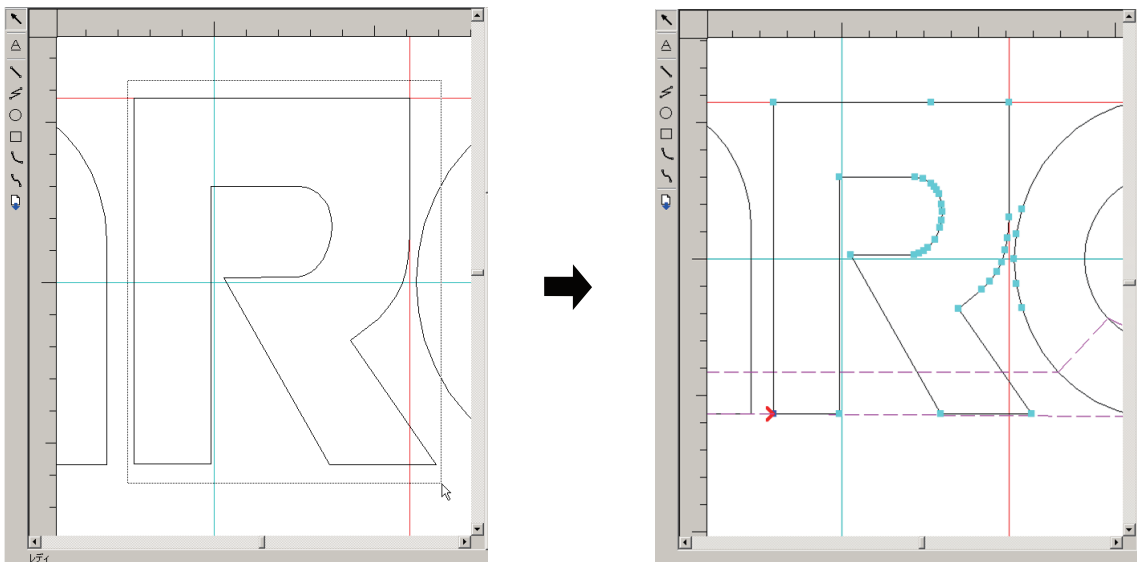

2 Click [Grouping] on the toolbar to group the text "R."

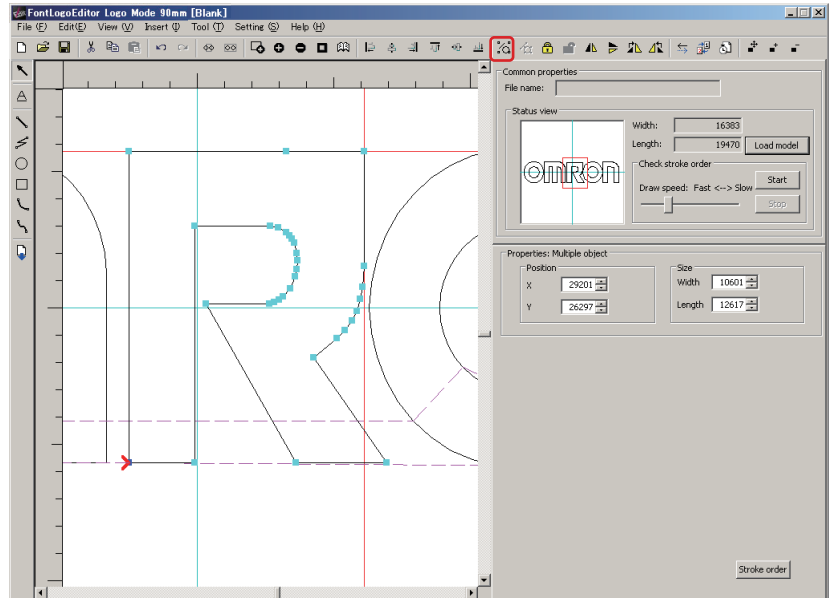

 **Additional Information**

- To fill, group the target range.
- The object to be filled must be drawn with a continuous line. If the object is not drawn with a continuous line, the following message will appear and the object cannot be filled.



When an object is selected, the starting and ending points of the markings for the object are displayed in blue, and the relay points are displayed in light blue. Furthermore, the scanning direction of the laser is indicated by the red arrows. For continuous lines, only one red arrow is displayed. For non-continuous lines, several arrows are displayed.

- Non-continuous line (2 lines of | and R)

- Continuous line

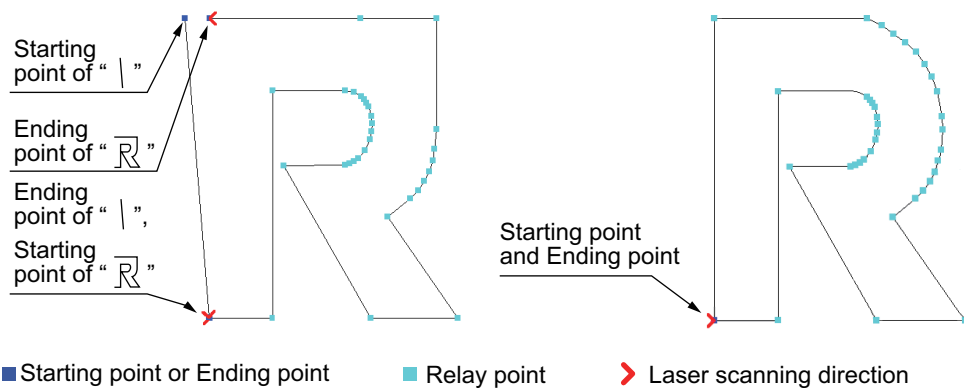

- 3 Select the [Yes/No] checkbox under [Fill] in the [Properties] area.

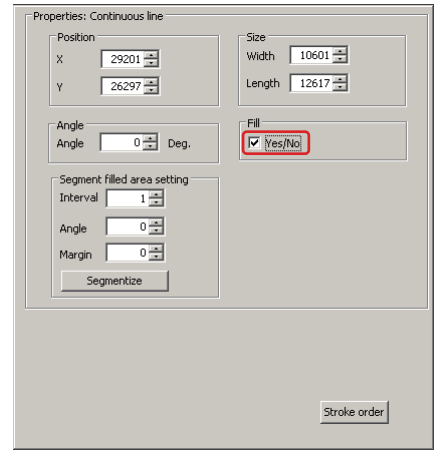

The text "R" lines will change to red.

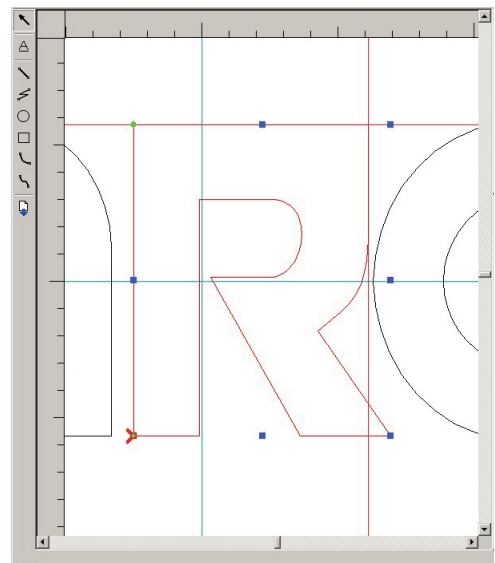

Additional Information

When [Fill] is set to the "Yes" setting, the outline of the text/graphic drawn is displayed in red. The area enclosed by the red outline will be filled in actual marking.

- 4 Repeat the same steps to fill other texts.

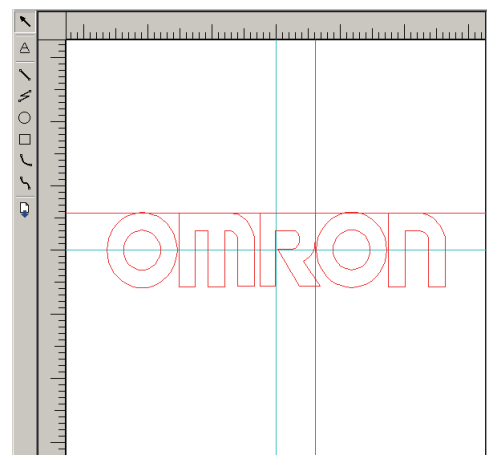

Additional Information

Fill segmentation

Line segments can be applied to a fill. Upon selecting an object that has been filled, enter the segment interval, angle and margin in [Segment filled area setting], and click [Segmentize].

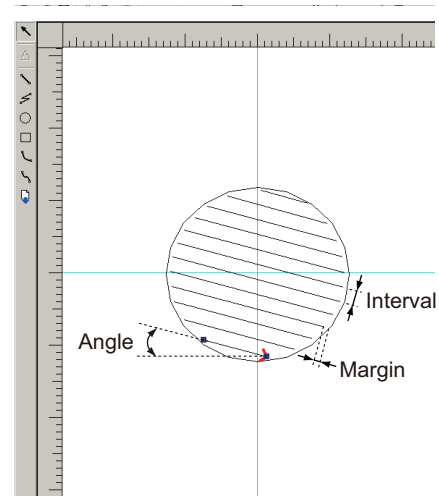
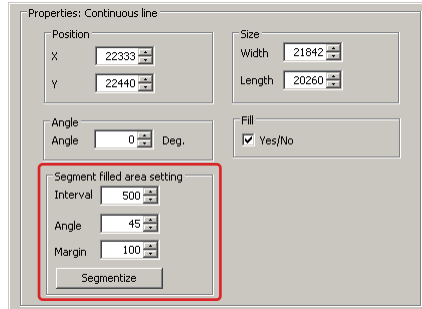

11

● Setting the stroke order

- 1 Click [Stroke order optimization] on the toolbar to optimize the stroke order.

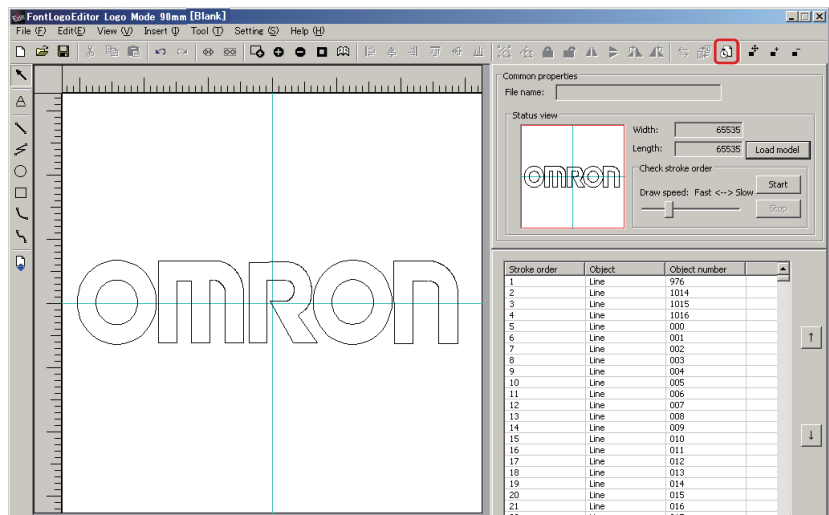

Additional Information

- If necessary, click [Tool] on the menu bar and select [Stroke order] to make fine-tuning to the stroke order.
- When objects are grouped, the stroke order is set for the objects that belong to that group.

● **Saving the logo data**

- 1 Click [File] on the menu bar, select [Save as], and save a file with a new name.

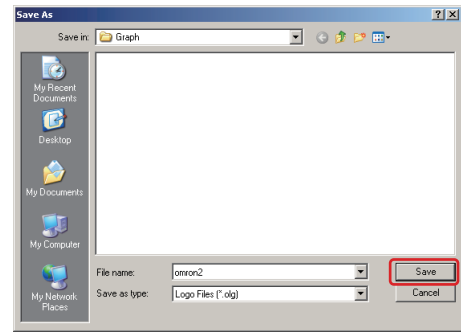

Additional Information

If logo data in DXF format was saved by the Font logo editor, the logo file extension will be ".olg" to be used with the laser marker. Therefore, keep in mind that the data will no longer be used with other software applications.

11.7 Installing Data to Laser Marker

Install each data set to the laser marker to perform actual marking.

1 Checking the data with the offline editing software

Browse and check the data created with the offline editing software.

To browse data with the offline editing software while editing it with the Font logo editor, click [Tool] on the menu bar, and select [Font logo data update] on the offline editing software to update the offline editing software data.

2 Transferring data from the offline editing software to USB memory

On the online editing software, click [File] on the menu bar, select [Data transfer] and transfer data to the USB memory.

3 Installing the data to Laser Marker

On the laser marker, click [File] on the menu bar, and select [Data transfer] to install data.



Reference

- "Transferring Data (page 1-6)"
-



Additional Information

The save folders are as follows. (Default installation folders)

The save folders are the same for the Font logo editor and the offline editing software.

Under C:\OMRON\MX-Z Offline Editing Software\Bin\Data,

- \Font: Font data
 - \Graph: Logo (graphic) data
 - \Pattern: Pattern data
-



Appendix

A.1	Specifications of Menu Bar and Toolbar	A-2
A.2	Menu Item List.....	A-9
A.3	DXF Files.....	A-11
A.4	ASCII Code Table.....	A-12
A.5	Shift-JIS Code Table.....	A-13
A.6	List of Display Codes.....	A-23
A.7	GS1 Code AI List.....	A-26

A.1 Specifications of Menu Bar and Toolbar

Manu bar

■ [File] menu

Performs marking data-related operations.

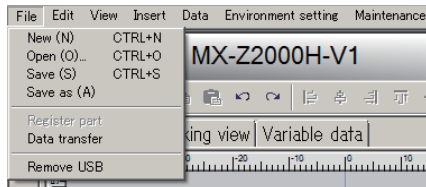

Item	Description
New	Creates new marking data.
Open	Opens the existing marking data.
Save	Saves the existing marking data.
Save as	Saves the new or existing marking data with a name.
Register part	Registers a single or multiple blocks to a single part file.
Data transfer	Saves marking data, etc. to USB memory or installs marking data, etc. from USB memory.
Remove USB (Marker software only)	Safely removes the USB memory from the system.
End (Offline editing software only)	Ends the offline editing software.

■ [Edit] menu

Performs operations to edit the blocks on the sheet.

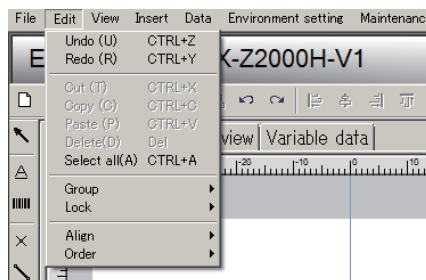

Item	Description	
Undo	Undoes the operation and restores the previous condition.	
Redo	Executes the operation performed in [Undo] again.	
Cut	Cuts the selected block.	
Copy	Copies the selected block.	
Paste	Pastes the cut or copied block.	
Delete	Deletes the selected block.	
Select all	Selects all blocks on the sheet.	
Group	Group	Groups the selected multiple blocks.
	Ungroup	Ungroups the selected blocks.

Item		Description
Lock	Lock	Locks the selected blocks so that they cannot be moved.
	Unlock	Unlocks the locked blocks selected to be unlocked.
Align	Left	Aligns the selected multiple blocks to the left.
	Horizontal center	Aligns the selected multiple blocks horizontally at the center.
	Right	Aligns the selected multiple blocks to the right.
	Top	Aligns the selected multiple blocks to the top.
	Vertical center	Aligns the selected multiple blocks vertically at the center.
	Bottom	Aligns the selected multiple blocks to the bottom.
Order	Bring to front	When blocks are overlapping one another, this moves the selected block to the foreground.
	Send to back	When blocks are overlapping one another, this moves the selected block to the background.
	Bring forward	When blocks are overlapping one another, this moves the selected block forward by one.
	Send backward	When blocks are overlapping one another, this moves the selected block backward by one.

■ [View] menu

Performs operations to display the blocks on the sheet.

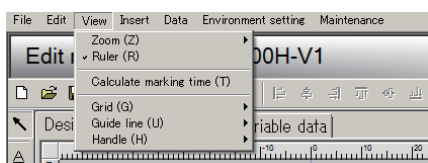

Item		Description
Zoom	Seamless zoom	Zooms in on the area specified (dragged) by the pointer.
	Zoom in	Zooms in at x 2 of the current display magnification ratio.
	Zoom out	Zooms out at x 1/2 of the current display magnification ratio.
	Fit	Sets to the magnification ratio of x 1.0 (100%) regardless of the current display magnification ratio.
Ruler		A ruler is displayed on the sheet.
Calculating marking time		Simulates the marking time.
Grid	View	Grids are displayed on the sheet.
Guide line	View	A guideline is displayed on the sheet.
	Add horizontal line	Adds a guide line (horizontal line).
	Add vertical line	Adds a guide line (vertical line).
	Delete all	Deletes all guide lines.
Handle	Snap	Snaps the block handle to the handle of another block within the specified distance.

■ **[Insert] menu**

Inserts a block on the sheet.

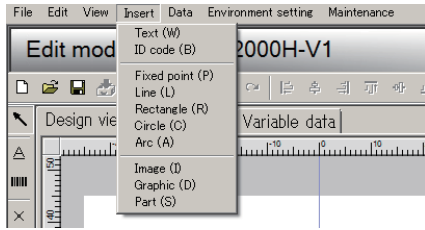

Item	Description
Text	Inserts a string block. Date/time and counter are also marked.
ID code	Inserts a bar code/2D code block.
Fixed point	Inserts a fixed point block.
Line	Inserts a straight line block.
Rectangle	Inserts a rectangle (box) block.
Circle	Inserts a circle block.
Arc	Inserts an arc block.
Image	Inserts an image file (BMP/JPEG/PNG format) block.
Graphic	Inserts a graphic file (DXF format) block.
Part	Inserts a part file.

■ **[Data] menu**

Displays a list of blocks and specifies the data table and counter settings.

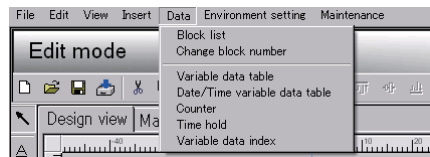

Item	Description
Block list	Displays a list of blocks that are registered to the marker software.
Change block number	Changes the registered block number.
Variable data table	Creates a variable data table (string, image, shape).
Date/Time variable data table	Creates a date/time variable data table (string, image, shape).
Counter	Sets the counter.
Time hold	Enables time hold.
Variable data index	Changes the index number for the variable data table.

■ [Environment setting] menu

Specifies the operating environment settings of this system.

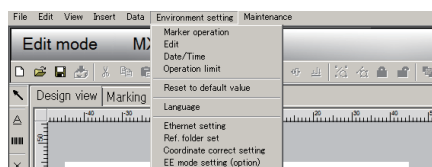

Item	Description
Marker operation (Marker software only)	Specifies the I/O settings, and communication and startup settings.
Edit	Specifies the grid settings, snap interval settings, grid/guideline view settings at startup, and handle snap settings.
Date/Time (Marker software only)	Sets the date and time.
Operation limit (Marker software only)	Specifies the operational limit settings.
Reset to default value	Restores the factory setting default value of [Common setting] or each block property.
Language	Sets the software display language (Japanese/English).
Model (Offline editing software only)	Set the target models for the data processed with the offline editing software.
Ethernet setting (Marker software only)	The IP address and other settings required for Ethernet communication are specified.
Ref. folder set	Specify the folder referencing the set data.
Coordinate correct setting (Marker software only)	Sets the marking coordinate correction value.
EE mode setting (option)	Switches between the standard mode and EE mode.

A

■ [Maintenance] menu (Marker software only)

Specifies the settings and performs operations related to maintenance and adjustment of the system.

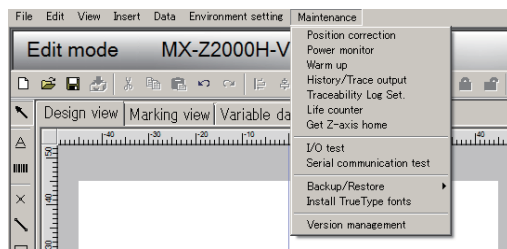

Item	Description
Position correction	Sets the marking position and focus distance settings.
Power monitor	Measures the laser power of this system. Performs sensor corrections as necessary.
Warm up	Manually warms up this system.
History/Trace output	Acquires operation and error histories in text format.
Traceability log setting	Selects marking data, counter information, and other log data and outputs it to the specified output destination.
Life counter	Indicates the system operation time.
Get Z-axis home	Gets home of the Z-axis.
I/O test	For I/O communication control, the buttons, the ON/OFF of the I/O terminal block and the I/O connector are manually operated.
Serial communication test	For serial communication control, the data is manually entered to communicate.
Backup/Restore	Backs up and restores all marking data and the system settings on the system.
Install TrueType fonts	Installs the TrueType font saved in the USB memory to the system.
Version management	Indicates the hardware and software information of the system.

■ [Tool] menu (Offline editing software only)

Starts the Font logo editor.

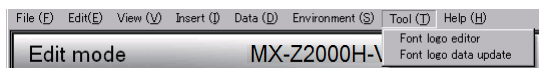

Item	Description
Font logo editor	Starts the Font logo editor.
Font logo data update	This is used to reference data on the main system while editing with the Font logo editor. When this is executed, the data on the main system is updated.

■ [Help] menu (Offline editing software only)

This manual and the marker software version are displayed.

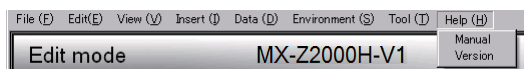









Item	Description
Manual	Displays this manual (PDF file).
Version	Displays the offline editing software version.





Toolbar

Performs marking data-related operations and operations to edit the marking content in the view area. The items and functions are the same as those of [File] and [Edit] on the menu bar.



Tool	Name	Function
	New	Creates new marking data.
	Open	Opens the existing marking data.
	Save	Saves the existing marking data.
	Register part	Registers a single or multiple blocks to a part file.
	Cut	Cuts the selected block.
	Copy	Copies the selected block.
	Paste	Pastes the cut or copied block.
	Undo	Undoes the operation and restores the previous condition.
	Redo	Executes the operation performed in [Undo] again.
	Left	Aligns the selected multiple blocks to the left.
	Horizontal center	Aligns the selected multiple blocks horizontally at the center.
	Right	Aligns the selected multiple blocks to the right.
	Top	Aligns the selected multiple blocks to the top.
	Vertical center	Aligns the selected multiple blocks vertically at the center.
	Bottom	Aligns the selected multiple blocks to the bottom.
	Group	Groups the selected multiple blocks.
	Ungroup	Ungroups the selected blocks.
	Lock	Locks the selected blocks so that they cannot be moved.

A

Tool	Name	Function
	Unlock	Unlocks the selected block.
	Bring to front	When blocks are overlapping one another, this moves the selected block to the foreground.
	Send to back	When blocks are overlapping one another, this moves the selected block to the background.
	Bring forward	When blocks are overlapping one another, this moves the selected block forward by one.
	Send backward	When blocks are overlapping one another, this moves the selected block backward by one.

A.2 Menu Item List

Yes: Available No: Not available

Menu	Sub menu	Marker software	Offline editing software
File	New	Yes	Yes
	Open	Yes	Yes
	Save	Yes	Yes
	Save as	Yes	Yes
	Register part	Yes	Yes
	Data transfer	Yes	Yes
	Remove USB	Yes	No
	End	No	Yes
Edit	Undo	Yes	Yes
	Redo	Yes	Yes
	Cut	Yes	Yes
	Copy	Yes	Yes
	Paste	Yes	Yes
	Delete	Yes	Yes
	Select all	Yes	Yes
	Group	Yes	Yes
	Lock	Yes	Yes
	Align	Yes	Yes
Order	Yes	Yes	
View	Zoom	Yes	Yes
	Ruler	Yes	Yes
	Calculate marking time	Yes	Yes
	Grid	Yes	Yes
	Guide line	Yes	Yes
	Handle	Yes	Yes
Insert	Text	Yes	Yes
	ID code	Yes	Yes
	Fixed point	Yes	Yes
	Line	Yes	Yes
	Rectangle	Yes	Yes
	Circle	Yes	Yes
	Arc	Yes	Yes
	Image	Yes	Yes
	Graphic	Yes	Yes
Part	Yes	Yes	
Data	Block list	Yes	Yes
	Change block number	Yes	Yes
	Variable data table	Yes	Yes
	Date/Time variable data table	Yes	Yes
	Counter	Yes	Yes
	Time hold	Yes	Yes
	Variable data index	Yes	Yes

A

Menu	Sub menu	Marker software	Offline editing software
Environment Setting	Marker operation	Yes	No
	Edit	Yes	Yes
	Date/Time	Yes	No
	Operation limit	Yes	No
	Reset to default value	Yes	Yes
	Language	Yes	Yes
	Model	No	Yes
	Ethernet Setting	Yes	No
	Ref. folder set	Yes	Yes
	Coordinate correct setting	Yes	No
	EE mode setting (option)	Yes	Yes
Maintenance	Position correction	Yes	No
	Power monitor	Yes	No
	Warm up	Yes	No
	History/Trace output	Yes	No
	Traceability log setting	Yes	No
	Life counter	Yes	No
	Get Z-axis home	Yes	No
	I/O test	Yes	No
	Serial communication test	Yes	No
	Backup/Restore	Yes	No
	Install TrueType fonts	Yes	No
Version management	Yes	No	
Tool	Font logo editor	No	Yes
	Font logo data update	No	Yes
Help	Manual	No	Yes
	Version	No	Yes

Operation mode	Marker software	Offline editing software
Edit mode	Yes	Yes
Operation mode	Yes	No
Test marking	Yes	No

A.3 DXF Files

DXF Data Supported on This System

The DXF data with which operations have been verified on this system are as follows.

- AutoCAD R12 format by Autodesk

Conversion of DXF Data Elements

When DXF data is loaded by this system, DXF data elements are converted by the system as follows.

DXF file		Conversion by the system		
DXF element	Shape name	Conversion type		Restrictions
3DFACE	3D surface	Shp	Straight line/ fixed point	Ignore Z coordinate.
ARC	Arc	Shp	Arc	–
CIRCLE	C	Shp	Arc	–
ELLIPSE	Ellipse	Shp	Arc	–
INSERT	Block insert	Shp	Straight line/arc/text	–
LINE	Segment	Shp	Ln	A broken line is converted into multiple lines.
LWPOLYLINE	Lightweight polyline	Shp	Ln	–
MLINE	Multi-line	Shp	Ln	Straight line only
POLYLINE	Polyline	Shp	Ln	As coefficient of expansion at the border lines, 0 (normal) and 1 (closed interval) are supported.
SEQEND	End of entity	Shp	–	–
SOLID	Fill	Shp	Ln	Supported by the laser marker fill logic.
SPLINE	Free curve	Shp	Ln	–
TRACE	Bold	Shp	Ln	All lines other than the bold type are SOLID.
VERTEX	Polyline vertex	Shp	–	–
ATTRIB	Attribute	Text	Text	The font is converted to the one specified by the user.
MTEXT	Multi-text	Text	Text	The font is converted to the one specified by the user. Code strings are not read.
TEXT	Text	Text	Text	The font is converted to the one specified by the user. Italics are ignored.

A.4 ASCII Code Table

		Upper 4 bits							
		0	1	2	3	4	5	6	7
Lower 4 bits	0	NL	DE	SP	0	@	P	`	p
	1	SH	D1	!	1	A	Q	a	q
	2	SX	D2	"	2	B	R	b	r
	3	EX	D3	#	3	C	S	c	s
	4	ET	D4	\$	4	D	T	d	t
	5	EQ	NK	%	5	E	U	e	u
	6	AK	SN	&	6	F	V	f	v
	7	BL	EB	'	7	G	W	g	w
	8	BS	CN	(8	H	X	h	x
	9	HT	EM)	9	I	Y	i	y
	A	LF	SB	*	:	J	Z	j	z
	B	HM	EC	+	;	K	[k	{
	C	CL	FS	,	<	L	\	l	
	D	CR	GS	-	=	M]	m	}
	E	SO	RS	.	>	N	^	n	~
	F	SI	US	/	?	O	_	o	

A.5 Shift-JIS Code Table

Code	01	02	03	04	05	06	07	08	09	0A	0B	0C	0D	0E	0F	
0020		!	"	#	\$	%	&	'	()	*	+	,	-	.	/
0030	0	1	2	3	4	5	6	7	8	9	:	;	<	=	>	?
0040	@	A	B	C	D	E	F	G	H	I	J	K	L	M	N	O
0050	P	Q	R	S	T	U	V	W	X	Y	Z	[\]	^	_
0060	`	a	b	c	d	e	f	g	h	i	j	k	l	m	n	o
0070	p	q	r	s	t	u	v	w	x	y	z	{		}	~	
00a0		。	「	」	、	・	ヲ	ア	イ	ウ	エ	オ	カ	キ	ク	ツ
00b0	-	ア	イ	ウ	エ	オ	カ	キ	ク	ケ	コ	サ	シ	ス	セ	ソ
00c0	タ	チ	ツ	テ	ト	ナ	ニ	ヌ	ノ	ハ	ヒ	フ	ハ	ホ	マ	
00d0	ミ	ム	メ	モ	ヤ	ユ	ヨ	ラ	リ	ル	レ	ロ	ワ	ヰ	ヱ	
8140		、	。	、	、	、	、	、	、	、	、	、	、	、	、	、
8150	—	—	、	、	、	、	、	、	、	、	、	、	、	、	、	、
8160	~		
8170	}	<	>	<	>	「	」	『	』	【	】	+	-	±	×	
8180	÷	=	≠	<	>	≦	≧	∞	∴	♂	♀	°	′	″	℃	¥
8190	\$	¢	£	%	#	&	*	@	§	☆	★	○	●	◎	◇	◆
81A0	□	■	△	▲	▽	▼	※	〒	→	←	↑	↓	≡			
81B0									∈	∋	⊆	⊇	⊂	⊃	∪	∩
81C0									∧	∨	¬	⇒	⇔	∀	∃	
81D0												∠	⊥	∩	∂	∇
81E0	≡	≪	≫	√	∞	∞	∴	∫	∫							
81F0	Å	‰	#	b	♪	†	‡	¶					○			
8240																0
8250	1	2	3	4	5	6	7	8	9							
8260	A	B	C	D	E	F	G	H	I	J	K	L	M	N	O	P
8270	Q	R	S	T	U	V	W	X	Y	Z						
8280		a	b	c	d	e	f	g	h	i	j	k	l	m	n	o
8290	p	q	r	s	t	u	v	w	x	y	z					あ
82A0	あ	い	い	う	う	え	え	お	お	か	が	き	ぎ	く	く	け
82B0	げ	こ	こ	さ	ざ	し	じ	す	ず	せ	ぜ	そ	ぞ	た	だ	ち
82C0	ぢ	っ	っ	づ	て	で	と	ど	な	に	ぬ	ね	の	は	ば	ば
82D0	ひ	び	び	ふ	ぶ	ふ	へ	べ	ぺ	ほ	ぼ	ぽ	ま	み	む	め
82E0	も	ゃ	ゃ	ゅ	ゅ	ょ	ょ	ら	り	る	れ	ろ	わ	わ	る	る
82F0	を	ん														
8340	ア	ア	イ	イ	ウ	ウ	エ	エ	オ	オ	カ	ガ	キ	ギ	ク	グ
8350	ケ	ゲ	コ	ゴ	サ	ザ	シ	ジ	ス	ズ	セ	ゼ	ソ	ゾ	タ	ダ
8360	チ	ヂ	ツ	ツ	ツ	テ	デ	ト	ド	ナ	ニ	ヌ	ネ	ノ	ハ	バ
8370	パ	ヒ	ビ	ピ	フ	ブ	プ	ヘ	ベ	ペ	ホ	ポ	ポ	マ	ミ	
8380	ム	メ	モ	ヤ	ヤ	ユ	ユ	ヨ	ヨ	ラ	リ	ル	レ	ロ	ワ	ワ
8390	キ	キ	ヲ	ン	ヴ	カ	ケ									A
83A0	B	Γ	Δ	E	Z	H	Θ	I	K	Λ	M	N	Ξ	O	Π	P
83B0	Σ	T	Υ	Φ	X	Ψ	Ω									α
83C0	β	γ	δ	ε	ζ	η	θ	ι	κ	λ	μ	ν	ξ	ο	π	ρ
83D0	σ	τ	υ	φ	χ	ψ	ω									
8440	A	Б	В	Г	Д	Е	Ё	Ж	З	И	Й	К	Л	М	Н	О
8450	П	Р	С	Т	У	Ф	Х	Ц	Ч	Ш	Щ	Ъ	Ы	Ь	Э	Ю
8460	Я															
8470	a	б	в	г	д	e	ё	ж	з	и	й	к	л	м	н	
8480	o	п	р	с	т	y	ф	x	ц	ч	ш	щ	ъ	ы	ь	э

Code	00	01	02	03	04	05	06	07	08	09	0A	0B	0C	0D	0E	0F
8490	Ю	Я														一
84A0	丨	┌	┐	└	├	┤	┥	┦	┧	┨	┩	┪	┫	┬	┭	┮
84B0	┯	┰	┱	┲	┳	┴	┵	┶	┷	┸	┹	┺	┻	┼	┽	
8740	①	②	③	④	⑤	⑥	⑦	⑧	⑨	⑩	⑪	⑫	⑬	⑭	⑮	⑯
8750	⑰	⑱	⑲	⑳	I	II	III	IV	V	VI	VII	VIII	IX	X		ミ
8760	キ	キ	メル	グラム	トン	アル	ヘル	リットル	フツ	キロ	ドル	セント	ユーロ	スイス	グ	mm
8770	cm	km	mg	kg	cc	m ²										靴
8780	々	々	No	KK	TEL	⓪	Ⓛ	Ⓜ	Ⓝ	Ⓞ	(株)	(有)	(代)	睨	疔	啣
8790	々	々	∫	∫	Σ	√	⊥	∠	∠	∠	∴	∩	∪			
8890																亜
88A0	唾	娃	阿	哀	愛	挨	始	逢	葵	茜	穗	惡	握	渥	旭	葦
88B0	芦	鱒	梓	庄	幹	扱	宛	姐	虻	飴	絢	綾	鮎	或	粟	裕
88C0	安	庵	按	暗	案	闇	鞍	杏	以	伊	位	依	偉	困	夷	委
88D0	威	尉	惟	意	慰	易	椅	為	畏	異	移	維	緯	胃	菱	衣
88E0	謂	違	遺	医	井	亥	域	育	郁	磯	一	壹	溢	逸	稻	茨
88F0	芋	鱒	允	印	咽	員	因	姻	引	飲	淫	胤	蔭			
8940	院	陰	隱	韻	吋	右	宇	烏	羽	迂	雨	卯	鶉	窺	丑	確
8950	臼	渦	噓	唄	鬱	蔚	鰻	姥	厩	浦	瓜	閨	樽	云	運	雲
8960	荏	餌	叡	宮	嬰	影	映	曳	采	永	泳	洩	瑛	盈	穎	穎
8970	英	衛	詠	銳	液	疫	益	馱	悅	謁	越	閱	榎	厭	円	
8980	園	堰	奄	宴	延	怨	掩	援	沿	演	炎	焰	煙	燕	猿	縁
8990	艷	苑	園	遠	鉛	鴛	塩	於	汚	甥	凹	央	奧	往	心	押
89A0	旺	橫	欧	殴	王	翁	襖	鶯	鳴	黄	岡	冲	荻	德	屋	憶
89B0	臆	桶	牡	乙	俺	卸	恩	温	穩	音	下	化	仮	何	伽	価
89C0	佳	加	可	嘉	夏	嫁	家	寡	科	暇	果	架	歌	河	火	珂
89D0	禍	禾	稼	箇	花	苛	茄	荷	華	菓	蝦	課	嘩	貨	迦	過
89E0	霞	蚊	俄	峨	我	牙	画	臥	芽	蛾	賀	雅	餓	駕	介	会
89F0	解	回	塊	壞	迴	快	怪	悔	恢	懷	戒	拐	改			
8A40	魁	晦	械	海	灰	界	皆	絵	芥	蟹	開	階	貝	凱	効	外
8A50	咳	害	崖	慨	概	涯	碍	蓋	街	該	鎧	骸	淫	馨	蛙	垣
8A60	柿	蛎	鈎	劃	嚇	各	廓	拡	攪	格	核	殼	獲	確	穫	覚
8A70	角	赫	較	郭	閣	隔	革	学	岳	榮	額	顎	掛	笠	櫛	
8A80	糧	梶	鯁	滂	割	喝	恰	括	活	渴	滑	葛	褐	轄	且	鯉
8A90	叶	栳	樺	鞆	株	兜	竈	蒲	釜	鎌	嚙	鴨	栢	茅	萱	粥
8AA0	刈	苻	瓦	乾	侃	冠	寒	刊	勸	勸	卷	喚	堪	姦	完	官
8AB0	寬	干	幹	患	感	慣	憾	換	敢	柑	桓	棺	款	歡	汗	漢
8AC0	潤	漣	環	甘	監	看	竿	管	簡	緩	缶	翰	肝	艦	莞	覲
8AD0	諫	貴	還	鑑	問	閑	閑	陷	韓	館	館	丸	含	岸	巖	玩
8AE0	癌	眼	岩	翫	贗	雁	頑	顏	願	企	伎	危	喜	器	基	奇
8AF0	嬉	寄	岐	希	幾	忌	揮	机	旗	既	期	棋	棄			
8B40	機	帰	毅	氣	汽	畿	祈	季	稀	紀	徽	規	記	貴	起	軌
8B50	輝	飢	騎	鬼	龜	偽	儀	妓	宜	戲	技	擬	欺	犧	疑	祇
8B60	義	蟻	誼	議	掬	菊	鞠	吉	吃	喫	桔	橘	詰	砧	杵	黍
8B70	却	客	脚	虐	逆	丘	久	仇	休	及	吸	宮	弓	急	救	
8B80	朽	求	汲	泣	灸	球	究	窮	笈	級	糾	給	旧	牛	去	居
8B90	巨	拒	拋	拳	渠	虛	許	距	鋸	漁	禦	魚	亨	亨	京	供
8BA0	俠	僑	兇	競	共	凶	協	匡	卿	叫	喬	境	峽	強	疆	怯
8BB0	恐	恭	挾	教	橋	況	狂	狹	矯	胸	脅	興	蕎	鄉	鏡	響
8BC0	饗	驚	仰	凝	堯	曉	業	局	曲	極	玉	桐	籽	僅	勤	均
8BD0	巾	錦	斤	欣	欽	琴	禁	禽	筋	緊	芹	菌	衿	襟	謹	近
8BE0	金	吟	銀	九	俱	句	区	狗	玖	矩	苦	軀	馭	駟	駒	具
8BF0	愚	虞	喰	空	偶	寓	遇	隅	串	櫛	釧	屑	屈			
8C40	掘	窟	沓	靴	轡	窪	熊	隈	桑	栗	繰	桑	鋤	勲	君	薰
8C50	訓	群	軍	郡	卦	袈	祁	係	傾	刑	兄	啓	圭	珪	型	契

Code	00	01	02	03	04	05	06	07	08	09	0A	0B	0C	0D	0E	0F
8C60	形	徑	患	慶	慧	憩	揭	携	敬	景	桂	溪	畦	稽	系	經
8C70	繼	繫	罽	莖	荊	蚩	計	詣	警	輕	頸	鷄	芸	迎	鯨	
8C80	劇	戟	擊	激	隙	朽	傑	欠	決	潔	穴	結	血	訣	月	件
8C90	儉	倦	健	兼	券	劍	喧	圈	堅	嫌	建	憲	懸	拳	捲	檢
8CA0	樞	牽	犬	獻	研	硯	絹	鼎	肩	見	謙	賢	軒	遣	鍵	險
8CB0	頭	駭	齧	元	原	廠	幻	弦	減	源	玄	現	絃	舩	言	諺
8CC0	限	乎	個	古	呼	固	姑	孤	己	庫	弧	戶	故	枯	湖	狐
8CD0	糊	袴	股	胡	菰	虎	誇	跨	鈷	雇	顧	鼓	五	互	伍	午
8CE0	吳	吾	娛	後	御	悟	梧	檣	瑚	碁	語	誤	護	醐	乞	鯉
8CF0	交	佼	侯	候	倖	光	公	功	効	勾	厚	口	向			
8D40	后	喉	坑	垢	好	孔	孝	宏	工	巧	巷	幸	広	庚	康	弘
8D50	恒	慌	抗	拘	控	攻	昂	晃	更	杭	校	梗	構	江	洪	浩
8D60	港	溝	甲	皇	硬	稿	糠	紅	紘	絞	綱	耕	考	肯	肱	腔
8D70	膏	航	荒	行	衡	講	貢	購	郊	酵	鉞	砢	鋼	閤	降	
8D80	項	香	高	鴻	剛	劫	号	合	壕	拷	濠	豪	轟	翹	克	刻
8D90	告	国	穀	酷	鵠	黑	獄	漉	腰	甌	忽	惚	骨	狍	込	此
8DA0	頃	今	困	坤	墾	婚	恨	懇	昏	昆	根	梱	混	痕	紺	艮
8DB0	魂	些	佐	又	唆	嵯	左	差	查	沙	磋	砂	詐	鎖	袞	坐
8DC0	座	挫	債	催	再	最	哉	塞	妻	宰	彩	才	採	栽	歲	濟
8DD0	災	采	犀	碎	砦	祭	齋	細	菜	裁	載	際	劑	在	材	罪
8DE0	財	冴	坂	阪	堺	榭	肴	咲	崎	埼	碯	鷺	作	削	昨	搾
8DF0	昨	朔	柵	窄	策	索	錯	桜	鮭	笹	匙	冊	刷			
8E40	察	撈	撮	擦	札	殺	薩	雜	皐	鯖	捌	鑄	鮫	皿	晒	三
8E50	傘	參	山	慘	撒	散	棧	燦	珊	產	算	纂	蚕	讚	贊	酸
8E60	餐	斬	暫	殘	仕	仔	伺	使	刺	司	史	嗣	四	士	始	姉
8E70	姿	子	屍	市	師	志	思	指	支	孜	斯	施	旨	枝	止	
8E80	死	氏	獅	祉	私	糸	紙	紫	肢	脂	至	視	詞	詩	試	誌
8E90	諮	資	賜	雌	飼	齒	事	似	侍	兒	字	寺	慈	持	時	次
8EA0	滋	治	爾	璽	痔	磁	示	而	耳	自	時	辭	汐	鹿	式	識
8EB0	鳴	竺	軸	穴	栗	七	叱	執	失	嫉	室	悉	湿	漆	疾	質
8EC0	実	蔀	篠	偲	柴	芝	屢	蕊	縞	舍	写	射	捨	赦	斜	煮
8ED0	社	紗	者	謝	車	遮	蛇	邪	借	勺	尺	杓	灼	爵	酌	积
8EE0	錫	若	寂	弱	惹	主	取	守	手	朱	殊	狩	珠	種	腫	趣
8EF0	酒	首	儒	受	呪	寿	授	樹	綬	需	囚	収	周			
8F40	宗	就	州	修	愁	捨	洲	秀	秋	終	繡	習	臭	舟	菟	衆
8F50	襲	讐	蹴	輯	週	酋	酬	集	醜	什	住	充	十	從	戎	柔
8F60	汁	涉	獸	縱	重	銃	叔	夙	宿	淑	祝	縮	肅	塾	熟	出
8F70	術	述	俊	峻	春	瞬	竣	舜	駿	准	循	旬	楯	殉	淳	
8F80	準	潤	盾	純	巡	遵	醇	順	処	初	所	暑	曙	渚	庶	緒
8F90	署	書	薯	諸	諸	助	叙	女	序	徐	恕	鋤	除	傷	償	勝
8FA0	匠	升	召	哨	商	唱	嘗	獎	妾	娼	宵	將	小	少	尚	庄
8FB0	床	廠	彰	承	抄	招	掌	捷	昇	昌	昭	晶	松	梢	樟	樵
8FC0	沼	消	涉	湘	燒	焦	照	症	省	硝	礁	祥	称	章	笑	粧
8FD0	紹	肖	菖	蔣	蕉	衝	裳	訟	証	詔	詳	象	賞	醬	鉦	鍾
8FE0	鐘	障	鞘	上	丈	丞	乘	冗	剩	城	場	壤	孃	常	情	擾
8FF0	条	杖	淨	狀	疊	穰	蒸	讓	釀	錠	囑	埴	飾			
9040	拭	植	殖	燭	織	職	色	触	食	蝕	辱	尻	伸	信	侵	唇
9050	娠	寢	審	心	慎	振	新	晋	森	榛	浸	深	申	疹	真	神
9060	秦	紳	臣	芯	薪	親	診	身	辛	進	針	震	人	仁	刃	塵
9070	壬	尋	甚	尽	腎	訊	迅	陣	靱	筭	誨	須	酢	凶	厨	
9080	逗	吹	垂	帥	推	水	炊	睡	粹	翠	衰	遂	醉	錐	錘	隨
9090	瑞	髓	崇	嵩	数	枢	趨	雛	据	杉	梠	菅	頗	雀	裾	澄
90A0	摺	寸	世	瀨	畝	是	淒	制	勢	姓	征	性	成	政	整	星
90B0	晴	棲	栖	正	清	牲	生	盛	精	聖	声	製	西	誠	誓	請

Code	00	01	02	03	04	05	06	07	08	09	0A	0B	0C	0D	0E	0F
90C0	逝	醒	青	靜	齊	稅	脆	隻	席	惜	戚	斥	昔	析	石	積
90D0	籍	績	脊	責	赤	跡	蹟	碩	切	拙	接	掇	折	設	窃	節
90E0	說	雪	絕	舌	蟬	仙	先	千	占	宣	專	尖	川	戟	扇	撰
90F0	栓	栴	泉	淺	洗	染	潛	煎	煽	旋	穿	箭	線			
9140	織	羨	腺	舛	船	薦	詮	賤	踐	選	遷	錢	銑	閃	鮮	前
9150	善	漸	然	全	禪	繕	膳	糲	嗜	塑	岨	措	曾	曾	楚	狙
9160	疏	疎	礎	祖	租	粗	素	組	蘇	訴	阻	遯	鼠	僧	創	双
9170	叢	倉	喪	壯	奏	爽	宋	層	匝	惣	想	搜	掃	插	搔	
9180	操	早	曹	巢	槍	槽	漕	燥	争	瘦	相	窓	糟	綵	綜	聰
9190	草	莊	葬	蒼	藻	裝	走	送	遭	鎗	霜	騷	像	增	憎	臟
91A0	葳	贈	造	促	側	則	即	息	捉	束	測	足	速	俗	属	賊
91B0	族	統	卒	袖	其	揃	存	孫	尊	損	村	遜	他	多	太	汰
91C0	訖	唾	墮	妥	惰	打	柁	舵	橈	陀	馱	驂	体	堆	对	耐
91D0	岱	帶	待	怠	態	戴	替	泰	滯	胎	腿	苔	袋	貸	退	逮
91E0	隊	黛	鯛	代	台	大	第	醍	題	鷹	淹	瀧	卓	啄	宅	托
91F0	扞	拓	沢	濯	琢	託	鐸	濁	諾	苜	夙	蛸	只			
9240	叩	但	達	辰	奪	脫	翼	豎	泚	棚	谷	狸	鱒	樽	誰	丹
9250	单	嘆	坦	担	探	旦	歎	淡	湛	炭	短	端	筆	綻	耽	胆
9260	蛋	誕	鍛	团	壇	彈	断	暖	檀	段	男	談	值	知	地	弛
9270	恥	智	池	痴	稚	置	致	蚰	遲	馳	築	畜	竹	筑	蓄	
9280	逐	秩	窒	茶	嫡	着	中	仲	宙	忠	抽	昼	柱	注	虫	衷
9290	註	耐	鑄	駐	樽	瀦	猪	苧	著	貯	丁	兆	凋	喋	寵	帖
92A0	帳	庁	弔	張	彫	徵	懲	挑	暢	朝	潮	牒	町	眺	聽	脹
92B0	腸	蝶	調	諜	超	跳	鈔	長	頂	烏	勅	抄	直	朕	沈	珍
92C0	賃	鎮	陳	津	墜	椎	槌	迫	鎚	痛	通	塚	柁	搥	槻	佃
92D0	漬	柘	辻	薦	綴	鏢	椿	漬	坪	壺	孀	紬	爪	吊	釣	鶴
92E0	亭	低	停	偵	荆	貞	呈	堤	定	帝	底	庭	廷	弟	悌	抵
92F0	挺	提	梯	汀	碇	禎	程	締	艇	訂	諦	蹄	遞			
9340	邸	鄭	釘	鼎	泥	摘	擢	敵	滴	的	笛	適	適	溺	哲	徹
9350	撤	轍	迭	鉄	典	填	天	展	店	添	纏	甜	貼	軫	顛	点
9360	伝	殿	澱	田	電	兎	吐	堵	塗	妬	屠	徒	斗	杜	渡	登
9370	菟	賭	途	都	鍍	砥	砺	努	度	土	奴	怒	倒	党	冬	
9380	凍	刀	唐	塔	塘	套	宕	島	鳴	悼	投	搭	東	桃	栲	棟
9390	盜	淘	湯	涛	灯	燈	当	痘	袴	等	答	筒	糖	統	到	董
93A0	蕩	藤	討	騰	豆	踏	逃	透	鐙	陶	頭	騰	鬪	働	動	同
93B0	堂	導	懂	撞	洞	瞳	董	胴	荀	道	銅	峠	鴛	匿	得	德
93C0	洸	特	督	禿	篤	毒	独	讀	朽	橡	凸	突	椽	屈	薦	苦
93D0	寅	酉	滄	噸	屯	悖	敦	沌	豚	遁	頓	吞	曇	鈍	奈	那
93E0	内	乍	凧	薙	謎	灘	捺	鍋	楷	馴	繩	啜	南	楠	軟	難
93F0	汝	二	尼	弑	迓	勻	賑	肉	虹	廿	日	乳	入			
9440	如	尿	菲	任	妊	忍	認	濡	襦	衤	寧	葱	猫	熱	年	念
9450	捻	撚	燃	粘	乃	迺	之	埜	囊	惱	濃	納	能	腦	膿	農
9460	覘	蚤	巴	把	播	霸	杷	波	派	琶	破	婆	罵	芭	馬	俳
9470	廢	捋	排	敗	杯	盃	牌	背	肺	輩	配	倍	培	媒	梅	
9480	煤	煤	猥	賈	壳	賠	陪	這	蠅	秤	矧	荻	伯	剥	博	拍
9490	柏	泊	白	箔	粕	舶	薄	迫	曝	漠	爆	縛	莫	駁	麥	函
94A0	箱	谿	箸	肇	筭	櫨	幡	肌	畑	畠	八	鉢	澆	癸	醜	髮
94B0	伐	罰	拔	筏	閥	鳩	晰	塙	蛤	隼	伴	判	半	反	叛	帆
94C0	搬	斑	板	汜	汎	版	犯	班	畔	繁	般	藩	販	範	采	煩
94D0	頒	飯	挽	晚	番	盤	磐	蕃	蚤	匪	卑	否	妃	庇	彼	悲
94E0	扉	批	披	斐	比	泌	疲	皮	碑	秘	緋	罷	肥	被	誹	費
94F0	避	非	飛	樋	簸	備	尾	微	枇	毘	琵琶	眉	美			
9540	鼻	柁	稗	匹	疋	髭	彥	膝	菱	肘	弼	必	畢	筆	逼	桧
9550	姬	媛	紐	百	謬	倭	彪	標	冰	漂	瓢	票	表	評	豹	廟

Code	00	01	02	03	04	05	06	07	08	09	0A	0B	0C	0D	0E	0F
9560	描	病	秒	苗	錨	鉞	蒜	蛭	鱈	品	彬	斌	浜	瀕	貧	賈
9570	頻	敏	瓶	不	付	埠	夫	婦	富	富	布	府	怖	扶	敷	
9580	斧	普	浮	父	符	腐	膚	芙	譜	負	賦	赴	阜	附	侮	撫
9590	武	舞	葡	蕪	部	封	楓	風	葺	落	伏	副	復	幅	服	福
95A0	腹	複	覆	淵	弗	扌	沸	仏	物	鮒	分	吻	噴	墳	憤	扮
95B0	焚	奮	粉	糞	紛	雰	文	聞	丙	併	兵	摒	幣	平	弊	柄
95C0	並	蔽	閉	陛	米	頁	僻	壁	癖	碧	別	警	蔑	篋	偏	變
95D0	片	篇	編	辺	返	遍	便	勉	娩	弁	鞭	保	鋪	鋪	圃	捕
95E0	步	甫	補	輔	穗	募	墓	慕	戊	暮	母	簿	菩	倣	俸	包
95F0	呆	報	奉	宝	峰	峯	崩	庖	抱	捧	放	方	朋			
9640	法	泡	烹	砲	縫	胞	芳	萌	蓬	蜂	褒	訪	豐	邦	鋒	飽
9650	鳳	鵬	乏	亡	傍	剖	坊	妨	帽	忘	忙	房	暴	望	某	棒
9660	冒	紡	肪	膨	謀	貌	貿	鉞	防	吠	頰	北	僕	卜	墨	撲
9670	朴	牧	睦	穆	鈎	勃	沒	殆	堀	幌	奔	本	翻	凡	盆	
9680	摩	磨	魔	麻	埋	妹	昧	枚	每	哩	模	幕	膜	枕	鮪	枉
9690	鱒	枺	亦	俣	又	抹	末	沫	迄	佟	繭	曆	万	慢	滿	漫
96A0	蔓	味	未	魅	巳	箕	岬	密	蜜	湊	蓑	稔	脈	妙	耗	民
96B0	眠	務	夢	無	牟	矛	霧	鷓	棕	婿	娘	冥	名	命	明	盟
96C0	迷	銘	鳴	姪	牝	滅	免	棉	綿	緬	面	麵	摸	模	茂	妄
96D0	孟	毛	猛	盲	網	耗	蒙	儲	木	默	目	杳	勿	餅	尤	戾
96E0	粉	貰	問	悶	紋	門	匆	也	冶	夜	爺	耶	野	弥	矢	厄
96F0	役	約	藥	訖	躍	靖	柳	藪	鏗	愉	愈	油	癒			
9740	諭	輸	唯	佑	優	勇	友	宥	幽	悠	憂	揖	有	柚	湧	涌
9750	猶	猷	由	祐	裕	誘	遊	邑	郵	雄	融	夕	予	余	与	譽
9760	輿	預	傭	幼	妖	容	庸	揚	搖	擁	曜	楊	樣	洋	溶	熔
9770	用	窯	羊	耀	葉	蓉	要	謠	踊	遙	陽	養	慾	抑	欲	
9780	沃	浴	翌	翼	淀	羅	螺	裸	來	萊	賴	雷	洛	絡	落	酪
9790	乱	卵	嵐	欄	濫	藍	蘭	覽	利	吏	履	李	梨	理	璃	痢
97A0	裏	裡	里	離	陸	律	率	立	律	掠	略	劉	流	溜	琉	留
97B0	硫	粒	隆	龜	龍	侶	慮	旅	虜	了	亮	僚	兩	凌	寮	料
97C0	梁	涼	獵	療	瞭	稜	糧	良	諒	遼	量	陵	領	力	綠	倫
97D0	厘	林	淋	熒	琳	臨	輪	隣	鱗	麟	瑠	罍	淚	累	類	令
97E0	伶	例	冷	勵	嶺	伶	玲	禮	苓	鈴	隸	零	靈	麗	齡	曆
97F0	歷	列	劣	烈	裂	廉	戀	憐	漣	煉	簾	練	聯			
9840	蓮	連	鍊	呂	魯	櫓	炉	賂	路	露	勞	婁	廊	弄	朗	樓
9850	榔	浪	漏	牢	狼	篋	老	聾	蠟	郎	六	麓	祿	肋	錄	論
9860	倭	和	話	歪	賄	脇	惑	梓	鷲	互	巨	鱷	詛	藁	蔴	椀
9870	灣	碗	腕													
9890																弍
98A0	丐	丕	个	卍	丶	井	丿	乂	乖	乘	亂	丿	豫	爭	舒	弍
98B0	于	亞	亟	亠	亢	京	毫	亶	从	仍	仄	仆	仂	仗	仞	仞
98C0	仟	价	伉	侏	估	佛	佝	佗	佇	佶	侈	侏	侗	佻	佩	佰
98D0	侑	佯	來	侖	儘	倪	俟	俎	俘	俛	俑	俚	侗	侑	俚	倚
98E0	倨	倔	倪	倥	倅	倅	倅	倡	倩	倅	倅	俯	們	倆	偃	假
98F0	會	偕	修	偈	倣	僂	僂	僂	僂	僂	僂	僂	僂	僂		
9940	僉	僂	傳	僂	僂	僂	僂	僂	僂	僂	僂	僂	僂	僂	僂	僂
9950	儕	儕	儕	儕	儕	儕	儕	儕	儕	儕	儕	儕	儕	儕	儕	儕
9960	兪	兮	冀	冂	冂	册	冉	冂	冂	冂	冂	冂	冂	冂	冂	冂
9970	冂	冂	冂	冂	冂	冂	冂	冂	冂	冂	冂	冂	冂	冂	冂	冂
9980	凰	冂	函	刃	刊	刂	刂	刂	刪	刮	刮	剎	剎	剎	剎	剎
9990	剎	剔	剪	剎	剎	剎	剎	剎	剎	剎	剎	剎	剎	剎	剎	剎
99A0	劬	劬	劬	劬	劬	劬	劬	劬	劬	劬	劬	劬	劬	劬	劬	劬
99B0	匆	匆	匆	匆	匆	匆	匆	匆	匆	匆	匆	匆	匆	匆	匆	匆
99C0	卅	卅	卅	卅	卅	卅	卅	卅	卅	卅	卅	卅	卅	卅	卅	卅

Code	00	01	02	03	04	05	06	07	08	09	0A	0B	0C	0D	0E	0F
99D0	廠	厶	參	纂	雙	叟	曼	變	叮	叨	叭	叭	吁	吽	呀	听
99E0	吭	吼	吮	吮	吩	吝	呎	咏	呵	咎	咄	呱	呷	咩	咒	呻
99F0	咀	呶	咄	咐	咆	哇	号	咸	啞	咬	哄	哈	咨			
9A40	咫	晒	咤	咤	尙	听	哥	哦	唏	唔	哽	哮	哭	哺	啡	嗽
9A50	唯	啣	啞	售	噉	啖	啖	陷	唸	喉	啞	喙	喀	咯	喊	喟
9A60	啞	啣	喘	啣	單	啼	喃	喻	喇	曉	嗚	嗅	嗟	嘎	嗜	嗟
9A70	噴	嘔	嗽	噴	噉	嗽	嘛	噠	噠	噐	營	嘴	嘶	嘲	噓	
9A80	噫	噤	嘯	噉	噪	噤	噤	噤	噤	噤	噤	噤	噤	噤	噤	噤
9A90	嚼	嚼	噉	噉	噉	噉	噉	噉	噉	噉	噉	噉	噉	噉	噉	噉
9AA0	國	圍	圓	團	圖	嗇	園	坎	坏	址	坎	圪	址	坏	坩	垂
9AB0	垩	坡	坩	坩	垓	垓	圪	垓	垓	垓	垓	垓	垓	垓	垓	垓
9AC0	坩	坩	坩	坩	坩	坩	坩	坩	坩	坩	坩	坩	坩	坩	坩	坩
9AD0	墟	墟	墟	墟	墟	墟	墟	墟	墟	墟	墟	墟	墟	墟	墟	墟
9AE0	壘	壯	壺	壺	壻	壺	壽	久	久	夂	夂	夢	夥	夫	夭	卒
9AF0	夸	夾	奇	奕	奂	奎	奚	奘	奢	奠	奧	獎	奩			
9B40	奸	妁	妝	佞	佞	妣	妣	姆	姨	姜	妍	姪	姚	娥	娟	娑
9B50	娜	娉	娉	娉	姪	婉	姬	娶	婢	婪	媚	媼	媼	媼	媼	媼
9B60	嬌	嫗	娉	嫩	嫖	嫖	嫖	嬌	嬋	嬋	嬋	嬋	嬋	嬋	嬋	嬋
9B70	嫵	嫵	子	孕	孚	孛	孛	孩	孰	孳	孳	學	孳	孳	一	
9B80	它	宦	宸	冤	寇	雀	寔	寐	寤	寤	寤	寤	寤	寤	寤	寤
9B90	實	尅	將	專	對	尔	尅	尅	尅	尸	尹	屁	屈	屎	屐	屐
9BA0	屏	孱	屬	屮	屮	岌	屹	岌	岌	岔	岌	岌	岌	岌	岌	岌
9BB0	岌	岌	岌	岌	岌	岌	岌	岌	岌	岌	岌	岌	岌	岌	岌	岌
9BC0	崑	崑	崑	崑	崑	崑	崑	崑	崑	崑	崑	崑	崑	崑	崑	崑
9BD0	嶢	嶢	嶢	嶢	嶢	嶢	嶢	嶢	嶢	嶢	嶢	嶢	嶢	嶢	嶢	嶢
9BE0	卮	卮	卮	卮	卮	卮	卮	卮	卮	卮	卮	卮	卮	卮	卮	卮
9BF0	幣	幫	幵	幵	幺	麼	广	庠	廁	廂	廈	廐	廐			
9C40	廖	廣	廐	廐	廐	廐	廐	廐	廐	廐	廐	廐	廐	廐	廐	廐
9C50	弃	莽	彝	彝	弋	弋	弋	弩	弭	弭	弭	彈	彌	彎	弯	亅
9C60	彖	彖	彖	彖	彭	彖	彖	徃	徃	徃	徃	徃	徃	徃	徃	徃
9C70	徃	徃	徃	徃	徃	徃	徃	徃	徃	徃	徃	徃	徃	徃	徃	徃
9C80	怙	怙	怙	怙	怙	怙	怙	怙	怙	怙	怙	怙	怙	怙	怙	怙
9C90	恹	恹	恹	恹	恹	恹	恹	恹	恹	恹	恹	恹	恹	恹	恹	恹
9CA0	悛	悛	悛	悛	悛	悛	悛	悛	悛	悛	悛	悛	悛	悛	悛	悛
9CB0	慍	慍	慍	慍	慍	慍	慍	慍	慍	慍	慍	慍	慍	慍	慍	慍
9CC0	慍	慍	慍	慍	慍	慍	慍	慍	慍	慍	慍	慍	慍	慍	慍	慍
9CD0	慍	慍	慍	慍	慍	慍	慍	慍	慍	慍	慍	慍	慍	慍	慍	慍
9CE0	慍	慍	慍	慍	慍	慍	慍	慍	慍	慍	慍	慍	慍	慍	慍	慍
9CF0	懺	懺	懺	懺	懺	懺	懺	戈	戈	戈	戈	戈	戈	戈	戈	戈
9D40	戛	戛	戛	戛	戛	戛	戛	戛	戛	扞	扞	扞	扞	扞	扞	扞
9D50	抉	抉	抉	抉	抉	抉	抉	抉	抉	扞	扞	扞	扞	扞	扞	扞
9D60	拜	拌	拊	拊	拊	拊	拊	拊	拊	拊	拊	拊	拊	拊	拊	拊
9D70	挾	捍	搜	捏	掖	掖	掖	掖	掖	掣	掣	掣	掣	掣	掣	掣
9D80	扞	掣	掣	掣	掣	掣	掣	掣	掣	掣	掣	掣	掣	掣	掣	掣
9D90	攝	搗	搗	搗	搗	搗	搗	搗	搗	搗	搗	搗	搗	搗	搗	搗
9DA0	擒	擅	擇	撻	擘	搗	搗	搗	搗	搗	搗	搗	搗	搗	搗	搗
9DB0	擴	擲	擺	攀	攪	攪	攪	攪	攪	攪	攪	攪	攪	攪	攪	攪
9DC0	畋	效	敖	敕	敘	敘	敘	敘	敘	數	斂	斂	斂	斂	斂	斂
9DD0	斷	旃	旃	旁	旃	旃	旃	旃	旃	旃	旃	旃	旃	旃	旃	旃
9DE0	杏	昵	昶	昶	昶	昶	昶	昶	昶	晞	晞	晞	晞	晞	晞	晞
9DF0	晰	晞	暈	暈	暈	暈	暈	暈	暈	暈	暈	暈	暈	暈	暈	暈
9E40	曄	曄	曄	曄	曄	曄	曄	曄	曄	曄	曄	曄	曄	曄	曄	曄
9E50	霸	尢	束	朶	朶	朶	朶	朶	朶	朶	朶	朶	朶	朶	朶	朶
9E60	杼	杪	杪	杪	杪	杪	杪	杪	杪	杪	杪	杪	杪	杪	杪	杪

Code	00	01	02	03	04	05	06	07	08	09	0A	0B	0C	0D	0E	0F
9E70	柝	柢	柝	枹	柎	柎	柎	柎	柎	柎	柎	柎	柎	柎	柎	
9E80	梳	栉	栉	栉	栉	栉	栉	栉	栉	栉	栉	栉	栉	栉	栉	桴
9E90	梵	栝	栝	栝	栝	栝	栝	栝	栝	栝	栝	栝	栝	栝	栝	栝
9EA0	棧	棕	櫻	椒	接	棗	棗	柳	棹	棠	楨	柎	柎	柎	柎	柎
9EB0	榆	楹	楷	胡	楸	楸	楸	楸	楸	楸	楸	楸	楸	楸	楸	楸
9EC0	棟	榑	榑	榑	榑	榑	榑	榑	榑	榑	榑	榑	榑	榑	榑	榑
9ED0	榑	榑	榑	榑	榑	榑	榑	榑	榑	榑	榑	榑	榑	榑	榑	榑
9EE0	榑	榑	榑	榑	榑	榑	榑	榑	榑	榑	榑	榑	榑	榑	榑	榑
9EF0	榑	榑	榑	榑	榑	榑	榑	榑	榑	榑	榑	榑	榑	榑	榑	榑
9F40	槩	槩	槩	槩	槩	槩	槩	槩	槩	槩	槩	槩	槩	槩	槩	槩
9F50	欒	欒	欒	欒	欒	欒	欒	欒	欒	欒	欒	欒	欒	欒	欒	欒
9F60	歛	歛	歛	歛	歛	歛	歛	歛	歛	歛	歛	歛	歛	歛	歛	歛
9F70	殫	殫	殫	殫	殫	殫	殫	殫	殫	殫	殫	殫	殫	殫	殫	殫
9F80	磨	氈	氓	气	氛	氫	氣	汞	汕	汩	汪	沂	洳	沚	沁	沛
9F90	汾	汨	汨	沒	沐	泄	決	泓	沽	泗	泗	沂	汨	沱	沾	沔
9FA0	泛	泯	泯	汨	洩	衍	洵	洳	洽	洸	洸	洳	洳	洳	洳	洳
9FB0	涓	泓	浚	浹	浙	涎	涕	濤	湴	淹	洳	淵	涵	淇	滄	涸
9FC0	淆	淬	淞	淌	淨	淒	浙	淺	淙	淤	涇	淪	淮	渭	湮	洑
9FD0	渙	浚	滄	渾	渣	湫	渫	淙	湍	渟	汧	渺	洳	渤	滿	渝
9FE0	游	澗	溪	澗	澗	澗	澗	澗	澗	澗	澗	澗	澗	澗	澗	澗
9FF0	溟	潁	溉	灌	漚	澗	滾	漿	滲	漱	滯	漲	滌			
E040	漾	漓	滷	澆	澆	澆	澆	澆	澆	澆	澆	澆	澆	澆	澆	澆
E050	溜	濂	潦	澳	澆	澆	澆	澆	澆	澆	澆	澆	澆	澆	澆	澆
E060	濮	濛	瀉	潘	澆	澆	澆	澆	澆	澆	澆	澆	澆	澆	澆	澆
E070	瀾	激	灑	灣	灸	炒	炯	炯	炬	炸	炳	炮	烟	炆	炆	炆
E080	烙	焉	烽	焜	焙	煥	熙	熙	熙	熒	煌	煖	煖	燧	燧	燧
E090	煥	熨	熬	爛	熨	熨	燒	燉	燉	燉	燉	燉	燉	燉	燉	燉
E0A0	燉	爍	爐	爛	爍	爭	爬	爍	爍	爍	爍	爍	爍	爍	爍	爍
E0B0	牴	牴	犁	犁	犇	犇	犇	犇	犇	犇	犇	犇	犇	犇	犇	犇
E0C0	狍	狼	狡	狹	狇	倏	猗	猗	猜	猜	猝	猴	獾	猩	猓	猓
E0D0	獎	獾	默	獾	獾	獨	獾	獸	獵	獻	獾	玳	玳	玳	玳	玳
E0E0	珥	珥	珥	珥	珥	瑯	瑯	瑯	瑯	瑯	玳	玳	玳	玳	玳	玳
E0F0	瑩	瑰	瑣	瑪	瑤	瑾	璋	璞	璧	瓊	瓏	瓏	瓏			
E140	瓠	瓣	趾	舂	瓮	甌	甌	甌	甌	甌	甌	甌	甌	甌	甌	甌
E150	甌	甌	甌	甌	甌	甌	甌	甌	甌	甌	甌	甌	甌	甌	甌	甌
E160	畫	畚	畸	當	疆	疇	疇	疊	疊	疊	疔	疔	疔	疔	疔	疔
E170	疔	疔	疔	疔	疔	疔	疔	疔	疔	疔	疔	疔	疔	疔	疔	疔
E180	疔	疔	疔	疔	疔	疔	疔	疔	疔	疔	疔	疔	疔	疔	疔	疔
E190	瘰	瘰	瘰	瘰	瘰	瘰	瘰	瘰	瘰	瘰	瘰	瘰	瘰	瘰	瘰	瘰
E1A0	癸	癸	癸	癸	癸	癸	癸	癸	癸	癸	癸	癸	癸	癸	癸	癸
E1B0	皺	孟	盍	蓋	盒	盞	盞	盞	盧	盞	盞	盞	盞	盞	盞	盞
E1C0	昵	眞	皆	眦	眦	眦	眦	眦	眦	眦	眦	眦	眦	眦	眦	眦
E1D0	瞎	瞠	瞠	瞠	瞠	瞠	瞠	瞠	瞠	瞠	瞠	瞠	瞠	瞠	瞠	瞠
E1E0	矜	矣	矮	矸	砌	砒	礦	砒	礪	礪	碎	砒	礪	礪	礪	礪
E1F0	碣	碩	礪	礪	礪	礪	礪	礪	礪	礪	磅	磊	磬			
E240	磧	磚	礪	礪	礪	礪	礪	礪	礪	礪	祀	祠	祇	崇	祚	祕
E250	祓	祺	祿	禊	禊	禊	齋	禪	禮	禳	禹	禹	秉	祗	秧	柮
E260	穉	秫	稈	稍	稈	稈	稈	稈	稈	稈	稻	稈	稈	稈	稈	稈
E270	穉	穉	穉	穉	穉	穉	穉	穉	穉	穉	穉	穉	穉	穉	穉	穉
E280	窶	窶	窶	窶	窶	窶	窶	窶	窶	窶	窶	窶	窶	窶	窶	窶
E290	竦	竭	坼	笱	笱	笱	笱	笱	笱	笱	笱	笱	笱	笱	笱	笱
E2A0	笱	筍	筍	筍	筍	筍	筍	筍	筍	筍	筍	筍	筍	筍	筍	筍
E2B0	籊	筍	筍	筍	筍	筍	筍	筍	筍	筍	筍	筍	筍	筍	筍	筍
E2C0	簞	簞	簞	簞	簞	簞	簞	簞	簞	簞	簞	簞	簞	簞	簞	簞

Code	00	01	02	03	04	05	06	07	08	09	0A	0B	0C	0D	0E	0F
E2D0	簞	簷	簫	簽	籌	籃	藪	簞	籐	籐	籐	籐	籐	籐	籐	籐
E2E0	粃	粃	粃	粃	粃	粃	粃	粃	粃	粃	粃	粃	粃	粃	粃	粃
E2F0	糝	糝	糝	糝	糝	糝	糝	糝	糝	糝	糝	糝	糝	糝	糝	糝
E340	紂	紂	紂	紂	紂	紂	紂	紂	紂	紂	紂	紂	紂	紂	紂	紂
E350	絮	綫	絳	經	綉	條	綬	紹	綵	綺	縈	縈	縈	縈	縈	縈
E360	總	綢	絢	絳	綸	緝	緝	緝	緝	緝	緝	緝	緝	緝	緝	緝
E370	縣	綵	綵	縱	縹	縹	縹	縹	縹	縹	縹	縹	縹	縹	縹	縹
E380	縷	縷	縷	縷	縷	縷	縷	縷	縷	縷	縷	縷	縷	縷	縷	縷
E390	辮	縷	縷	縷	縷	縷	縷	縷	縷	縷	縷	縷	縷	縷	縷	縷
E3A0	罍	罍	罍	罍	罍	罍	罍	罍	罍	罍	罍	罍	罍	罍	罍	罍
E3B0	羈	羈	羈	羈	羈	羈	羈	羈	羈	羈	羈	羈	羈	羈	羈	羈
E3C0	翅	翬	翬	翬	翬	翬	翬	翬	翬	翬	翬	翬	翬	翬	翬	翬
E3D0	耙	耜	耜	耜	耜	耜	耜	耜	耜	耜	耜	耜	耜	耜	耜	耜
E3E0	聰	聶	聶	聶	聶	聶	聶	聶	聶	聶	聶	聶	聶	聶	聶	聶
E3F0	胙	胙	胙	胙	胙	胙	胙	胙	胙	胙	胙	胙	胙	胙	胙	胙
E440	隋	腴	腴	腴	腴	腴	腴	腴	腴	腴	腴	腴	腴	腴	腴	腴
E450	膠	膈	膈	膈	膈	膈	膈	膈	膈	膈	膈	膈	膈	膈	膈	膈
E460	臍	臍	臍	臍	臍	臍	臍	臍	臍	臍	臍	臍	臍	臍	臍	臍
E470	舊	舍	舐	舖	舩	舩	舩	舩	舩	舩	舩	舩	舩	舩	舩	舩
E480	膾	膾	膾	膾	膾	膾	膾	膾	膾	膾	膾	膾	膾	膾	膾	膾
E490	苜	苟	苜	苜	苜	苜	苜	苜	苜	苜	苜	苜	苜	苜	苜	苜
E4A0	苜	苜	苜	苜	苜	苜	苜	苜	苜	苜	苜	苜	苜	苜	苜	苜
E4B0	莢	莢	莢	莢	莢	莢	莢	莢	莢	莢	莢	莢	莢	莢	莢	莢
E4C0	莢	莢	莢	莢	莢	莢	莢	莢	莢	莢	莢	莢	莢	莢	莢	莢
E4D0	林	菝	菝	菝	菝	菝	菝	菝	菝	菝	菝	菝	菝	菝	菝	菝
E4E0	蒿	菝	菝	菝	菝	菝	菝	菝	菝	菝	菝	菝	菝	菝	菝	菝
E4F0	菝	菝	菝	菝	菝	菝	菝	菝	菝	菝	菝	菝	菝	菝	菝	菝
E540	菝	菝	菝	菝	菝	菝	菝	菝	菝	菝	菝	菝	菝	菝	菝	菝
E550	菝	菝	菝	菝	菝	菝	菝	菝	菝	菝	菝	菝	菝	菝	菝	菝
E560	菝	菝	菝	菝	菝	菝	菝	菝	菝	菝	菝	菝	菝	菝	菝	菝
E570	蚪	蚋	蚋	蚋	蚋	蚋	蚋	蚋	蚋	蚋	蚋	蚋	蚋	蚋	蚋	蚋
E580	蛟	蛛	蛛	蛛	蛛	蛛	蛛	蛛	蛛	蛛	蛛	蛛	蛛	蛛	蛛	蛛
E590	蝮	蜻	蜻	蜻	蜻	蜻	蜻	蜻	蜻	蜻	蜻	蜻	蜻	蜻	蜻	蜻
E5A0	游	蝮	蝮	蝮	蝮	蝮	蝮	蝮	蝮	蝮	蝮	蝮	蝮	蝮	蝮	蝮
E5B0	蝮	蝮	蝮	蝮	蝮	蝮	蝮	蝮	蝮	蝮	蝮	蝮	蝮	蝮	蝮	蝮
E5C0	蠱	蠱	蠱	蠱	蠱	蠱	蠱	蠱	蠱	蠱	蠱	蠱	蠱	蠱	蠱	蠱
E5D0	袒	袒	袒	袒	袒	袒	袒	袒	袒	袒	袒	袒	袒	袒	袒	袒
E5E0	衤	衤	衤	衤	衤	衤	衤	衤	衤	衤	衤	衤	衤	衤	衤	衤
E5F0	襪	襪	襪	襪	襪	襪	襪	襪	襪	襪	襪	襪	襪	襪	襪	襪
E640	襪	襪	襪	襪	襪	襪	襪	襪	襪	襪	襪	襪	襪	襪	襪	襪
E650	覬	覬	覬	覬	覬	覬	覬	覬	覬	覬	覬	覬	覬	覬	覬	覬
E660	訃	訃	訃	訃	訃	訃	訃	訃	訃	訃	訃	訃	訃	訃	訃	訃
E670	誅	誅	誅	誅	誅	誅	誅	誅	誅	誅	誅	誅	誅	誅	誅	誅
E680	諤	諤	諤	諤	諤	諤	諤	諤	諤	諤	諤	諤	諤	諤	諤	諤
E690	謳	謳	謳	謳	謳	謳	謳	謳	謳	謳	謳	謳	謳	謳	謳	謳
E6A0	譬	譚	譚	譚	譚	譚	譚	譚	譚	譚	譚	譚	譚	譚	譚	譚
E6B0	腕	豎	豎	豎	豎	豎	豎	豎	豎	豎	豎	豎	豎	豎	豎	豎
E6C0	貌	賤	賤	賤	賤	賤	賤	賤	賤	賤	賤	賤	賤	賤	賤	賤
E6D0	賤	賤	賤	賤	賤	賤	賤	賤	賤	賤	賤	賤	賤	賤	賤	賤
E6E0	赴	赴	赴	赴	赴	赴	赴	赴	赴	赴	赴	赴	赴	赴	赴	赴
E6F0	跣	跣	跣	跣	跣	跣	跣	跣	跣	跣	跣	跣	跣	跣	跣	跣
E740	蹇	蹇	蹇	蹇	蹇	蹇	蹇	蹇	蹇	蹇	蹇	蹇	蹇	蹇	蹇	蹇
E750	躑	躑	躑	躑	躑	躑	躑	躑	躑	躑	躑	躑	躑	躑	躑	躑
E760	躑	躑	躑	躑	躑	躑	躑	躑	躑	躑	躑	躑	躑	躑	躑	躑

Code	00	01	02	03	04	05	06	07	08	09	0A	0B	0C	0D	0E	0F
E770	輞	輞	輦	輦	輦	輦	輦	輦	輦	輦	輦	輦	輦	輦	輦	
E780	輦	輦	輦	輦	輦	輦	輦	輦	輦	輦	輦	輦	輦	輦	輦	輦
E790	迨	迨	迨	迨	迨	迨	迨	迨	迨	迨	迨	迨	迨	迨	迨	迨
E7A0	遐	遐	遐	遐	遐	遐	遐	遐	遐	遐	遐	遐	遐	遐	遐	遐
E7B0	邁	邁	邁	邁	邁	邁	邁	邁	邁	邁	邁	邁	邁	邁	邁	邁
E7C0	鄆	鄆	鄆	鄆	鄆	鄆	鄆	鄆	鄆	鄆	鄆	鄆	鄆	鄆	鄆	鄆
E7D0	醪	醪	醪	醪	醪	醪	醪	醪	醪	醪	醪	醪	醪	醪	醪	醪
E7E0	鈞	鈞	鈞	鈞	鈞	鈞	鈞	鈞	鈞	鈞	鈞	鈞	鈞	鈞	鈞	鈞
E7F0	銜	銜	銜	銜	銜	銜	銜	銜	銜	銜	銜	銜	銜	銜	銜	銜
E840	銻	銻	銻	銻	銻	銻	銻	銻	銻	銻	銻	銻	銻	銻	銻	銻
E850	鎰	鎰	鎰	鎰	鎰	鎰	鎰	鎰	鎰	鎰	鎰	鎰	鎰	鎰	鎰	鎰
E860	鐐	鐐	鐐	鐐	鐐	鐐	鐐	鐐	鐐	鐐	鐐	鐐	鐐	鐐	鐐	鐐
E870	鑷	鑷	鑷	鑷	鑷	鑷	鑷	鑷	鑷	鑷	鑷	鑷	鑷	鑷	鑷	鑷
E880	閏	閏	閏	閏	閏	閏	閏	閏	閏	閏	閏	閏	閏	閏	閏	閏
E890	關	關	關	關	關	關	關	關	關	關	關	關	關	關	關	關
E8A0	陟	陟	陟	陟	陟	陟	陟	陟	陟	陟	陟	陟	陟	陟	陟	陟
E8B0	佳	佳	佳	佳	佳	佳	佳	佳	佳	佳	佳	佳	佳	佳	佳	佳
E8C0	霏	霏	霏	霏	霏	霏	霏	霏	霏	霏	霏	霏	霏	霏	霏	霏
E8D0	靛	靛	靛	靛	靛	靛	靛	靛	靛	靛	靛	靛	靛	靛	靛	靛
E8E0	鞅	鞅	鞅	鞅	鞅	鞅	鞅	鞅	鞅	鞅	鞅	鞅	鞅	鞅	鞅	鞅
E8F0	頡	頡	頡	頡	頡	頡	頡	頡	頡	頡	頡	頡	頡	頡	頡	頡
E940	顛	顛	顛	顛	顛	顛	顛	顛	顛	顛	顛	顛	顛	顛	顛	顛
E950	餘	餘	餘	餘	餘	餘	餘	餘	餘	餘	餘	餘	餘	餘	餘	餘
E960	饒	饒	饒	饒	饒	饒	饒	饒	饒	饒	饒	饒	饒	饒	饒	饒
E970	駱	駱	駱	駱	駱	駱	駱	駱	駱	駱	駱	駱	駱	駱	駱	駱
E980	騾	騾	騾	騾	騾	騾	騾	騾	騾	騾	騾	騾	騾	騾	騾	騾
E990	體	體	體	體	體	體	體	體	體	體	體	體	體	體	體	體
E9A0	鬆	鬆	鬆	鬆	鬆	鬆	鬆	鬆	鬆	鬆	鬆	鬆	鬆	鬆	鬆	鬆
E9B0	魏	魏	魏	魏	魏	魏	魏	魏	魏	魏	魏	魏	魏	魏	魏	魏
E9C0	鯊	鯊	鯊	鯊	鯊	鯊	鯊	鯊	鯊	鯊	鯊	鯊	鯊	鯊	鯊	鯊
E9D0	鯢	鯢	鯢	鯢	鯢	鯢	鯢	鯢	鯢	鯢	鯢	鯢	鯢	鯢	鯢	鯢
E9E0	鰲	鰲	鰲	鰲	鰲	鰲	鰲	鰲	鰲	鰲	鰲	鰲	鰲	鰲	鰲	鰲
E9F0	鳩	鳩	鳩	鳩	鳩	鳩	鳩	鳩	鳩	鳩	鳩	鳩	鳩	鳩	鳩	鳩
EA40	鴉	鴉	鴉	鴉	鴉	鴉	鴉	鴉	鴉	鴉	鴉	鴉	鴉	鴉	鴉	鴉
EA50	鷄	鷄	鷄	鷄	鷄	鷄	鷄	鷄	鷄	鷄	鷄	鷄	鷄	鷄	鷄	鷄
EA60	鶴	鶴	鶴	鶴	鶴	鶴	鶴	鶴	鶴	鶴	鶴	鶴	鶴	鶴	鶴	鶴
EA70	麪	麪	麪	麪	麪	麪	麪	麪	麪	麪	麪	麪	麪	麪	麪	麪
EA80	徽	徽	徽	徽	徽	徽	徽	徽	徽	徽	徽	徽	徽	徽	徽	徽
EA90	齟	齟	齟	齟	齟	齟	齟	齟	齟	齟	齟	齟	齟	齟	齟	齟
EAA0	榎	榎	榎	榎	榎	榎	榎	榎	榎	榎	榎	榎	榎	榎	榎	榎
ED40	纘	纘	纘	纘	纘	纘	纘	纘	纘	纘	纘	纘	纘	纘	纘	纘
ED50	仔	仔	仔	仔	仔	仔	仔	仔	仔	仔	仔	仔	仔	仔	仔	仔
ED60	僭	僭	僭	僭	僭	僭	僭	僭	僭	僭	僭	僭	僭	僭	僭	僭
ED70	厓	厓	厓	厓	厓	厓	厓	厓	厓	厓	厓	厓	厓	厓	厓	厓
ED80	塚	塚	塚	塚	塚	塚	塚	塚	塚	塚	塚	塚	塚	塚	塚	塚
ED90	岌	岌	岌	岌	岌	岌	岌	岌	岌	岌	岌	岌	岌	岌	岌	岌
EDA0	忍	忍	忍	忍	忍	忍	忍	忍	忍	忍	忍	忍	忍	忍	忍	忍
EDB0	擎	擎	擎	擎	擎	擎	擎	擎	擎	擎	擎	擎	擎	擎	擎	擎
EDC0	暄	暄	暄	暄	暄	暄	暄	暄	暄	暄	暄	暄	暄	暄	暄	暄
EDD0	摺	摺	摺	摺	摺	摺	摺	摺	摺	摺	摺	摺	摺	摺	摺	摺
EDE0	浯	浯	浯	浯	浯	浯	浯	浯	浯	浯	浯	浯	浯	浯	浯	浯
EDF0	瀟	瀟	瀟	瀟	瀟	瀟	瀟	瀟	瀟	瀟	瀟	瀟	瀟	瀟	瀟	瀟
EE40	玆	玆	玆	玆	玆	玆	玆	玆	玆	玆	玆	玆	玆	玆	玆	玆
EE50	璉	璉	璉	璉	璉	璉	璉	璉	璉	璉	璉	璉	璉	璉	璉	璉

Code	00	01	02	03	04	05	06	07	08	09	0A	0B	0C	0D	0E	0F
EE60	礧	禮	神	祥	禔	福	禎	竝	竝	靖	蛩	卷	精	紉	絜	粹
EE70	綠	緒	繪	罇	羨	羽	茁	芋	茂	菇	葦	蕒	蕒	蕒	蕒	
EE80	董	臆	薰	蕪	姓	螞	裴	訥	紳	詹	誦	閻	諛	諸	諶	諛
EE90	譙	賸	賴	賢	趕	尅	軋	返	逸	遼	郎	都	鄉	鄧	鈇	釗
EEA0	釗	釗	釗	釗	釗	釗	釗	釗	釗	鉀	鉀	鉀	鉀	鉀	鉀	鉀
EEB0	鉀	鉀	鉀	鉀	鉀	鉀	鉀	鉀	鉀	鉀	鉀	鉀	鉀	鉀	鉀	鉀
EEC0	鉀	鉀	鉀	鉀	鉀	鉀	鉀	鉀	鉀	鉀	鉀	鉀	鉀	鉀	鉀	鉀
EED0	隄	隄	靈	靈	靈	靈	青	靖	顛	顛	飯	飼	餽	館	醇	麟
EEE0	高	髡	紛	鮪	鮪	鮪	鮪	鰲	鰲	鰲	鰲	鰲	黑			i
EEF0	ii	iii	iv	v	vi	vii	viii	ix	x	ㄇ	丨	'	"			
FA40	i	ii	iii	iv	v	vi	vii	viii	ix	x	I	II	III	IV	V	VI
FA50	VII	VIII	IX	X	ㄇ	丨	'	"	(株)	No	Tel	∴	續	襲	鏃	銑
FA60	葩	倍	炆	昱	精	銀	昇	弼	丨	乞	任	公	仔	但	必	佞
FA70	佻	佻	佻	佻	佻	佻	佻	佻	佻	佻	佻	佻	佻	佻	佻	
FA80	癩	宜	冷	風	荔	加	荔	効	勛	勻	勻	匡	邵	厓	厲	扱
FA90	雙	吃	咏	咩	智	喆	至	坦	拱	埃	埔	垆	塚	增	塢	爰
FAA0	麥	萌	裔	萌	好	妹	孖	窠	甯	眞	寬	奈	岄	岑	岄	崧
FAB0	崑	崎	嶺	嶺	嶺	嶺	嶺	鉅	彈	彘	德	忒	愬	悅	愬	愬
FAC0	惕	愠	憚	愠	愠	愠	愠	或	柄	捷	摠	搗	擎	教	昀	昕
FAD0	昂	昉	昂	昉	昉	昉	昉	睽	晴	皙	晡	晡	晡	晡	晡	晡
FAE0	朗	杓	杓	杓	杓	杓	杓	杓	杓	杓	杓	杓	杓	杓	杓	杓
FAF0	櫛	櫛	櫛	櫛	櫛	櫛	櫛	沆	沆	沆	沆	沆	沆			
FB40	泣	滓	淙	清	澆	森	洵	湜	滯	漾	澗	澈	漸	濱	滢	澆
FB50	瀨	炅	炫	炅	焜	焜	焜	輝	熙	燁	燁	犰	犰	犰	猪	獾
FB60	均	珉	玠	均	琿	琿	琿	琦	琪	瑁	琮	瑤	璉	璉	瓶	峻
FB70	皂	皜	皜	皜	皜	益	睨	矧	砭	硎	砭	砭	礪	礪	神	
FB80	祥	禔	福	禎	竝	竝	靖	蛩	卷	精	紉	絜	粹	綠	緒	繪
FB90	罇	羨	羽	茁	芋	茂	菇	葦	蕒	蕒	蕒	蕒	蕒	蕒	蕒	
FBA0	姓	螞	裴	訥	紳	詹	誦	閻	諛	諸	諶	諛	譙	賸	賴	賢
FBB0	趕	尅	軋	返	逸	遼	郎	都	鄉	鄧	鈇	釗	釗	釗	釗	釗
FBC0	釗	鉀	鉀	鉀	鉀	鉀	鉀	鉀	鉀	鉀	鉀	鉀	鉀	鉀	鉀	鉀
FBD0	鉀	鉀	鉀	鉀	鉀	鉀	鉀	鉀	鉀	鉀	鉀	鉀	鉀	鉀	鉀	鉀
FBE0	鉀	鉀	鉀	鉀	鉀	鉀	鉀	鉀	鉀	鉀	鉀	鉀	鉀	鉀	鉀	鉀
FBF0	靈	靈	青	靖	顛	顛	飯	飼	餽	館	醇	麟	高			
FC40	髡	紛	鮪	鮪	鮪	鮪	鰲	鰲	鰲	鰲	鰲	黑				

A.6 List of Display Codes

Various settings in [Text] block (Refer to "[Text] Block (page 2-14)") are expressed in display codes. This section provides a list of display codes.

Date/Time

The display code will be as follows when set by selecting the [Date/Time] tab in the [Edit] dialog box while editing a [Text] block.

Display code	%aabdd%
---------------------	---------

Item	Description
aa	The "Digit" setting is displayed as a numeric value. Items displayed as 0 will not be marked.
b	The date/time will be displayed as follows based on the type of date and time specified in "Date/Time." Y = Year (AD), M = Month, D = Date, h = Hour, m = Minute, s = Second, N = Week, W = Day of the week, J = Total number of days
dd	Various settings regarding the date/time marking format will be converted into numeric values when displayed.*

* The value in dd is a numeric value of the following bits that are determined based on the settings, and converted into decimal values.

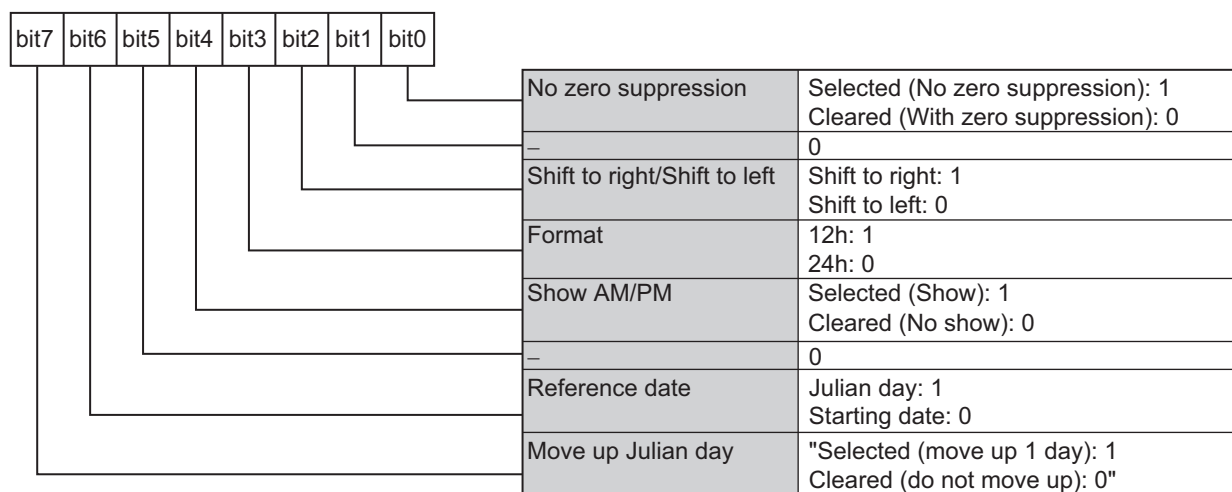

Counter

The display code will be as follows when set by selecting the [Counter] tab in the [Edit] dialog box while editing a [Text] block.

Display code	%aaCbbccdd%
---------------------	-------------

Item	Description
aa	The "Digit" setting is displayed as a numeric value. Items displayed as 0 will not be marked.
C	Indicates that this is a counter.
bb	Displays the "Counter No." setting (00 to 15).
cc	Displays the "Base" setting (02 to 36).
dd	Various settings regarding the counter marking format will be converted into numeric values when displayed.*

* The value in dd is a numeric value of the following bits that are determined based on the settings, and converted into decimal values.

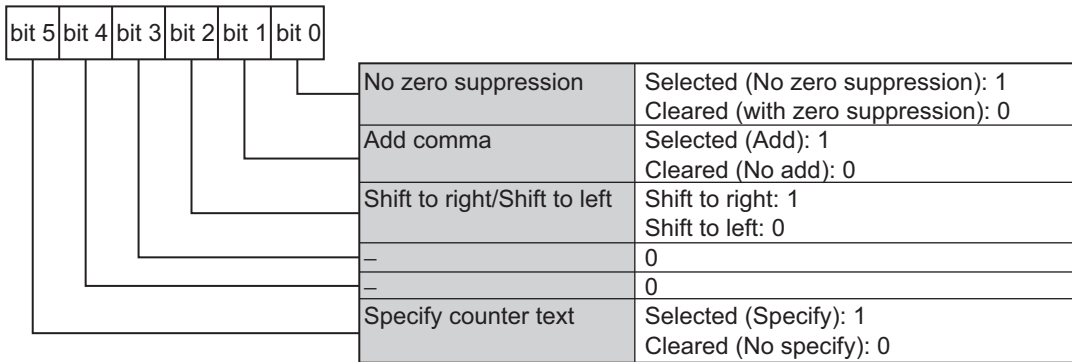

Variable data table

The display code will be as follows when set by selecting the [Variable data table] tab in the [Edit] dialog box while editing a [Text] block.

Display code	%Vabbb%
---------------------	---------

Item	Description
V	Indicates that this is a variable data table.
a	Indicates the type of the variable data table. 0: String table 1: Image table 2: Graphic table
bbb	Displays the "Table No." setting (000 to 063).

Date/Time variable data table

The display code will be as follows when set by selecting the [Date/Time variable data table] tab in the [Edit] dialog box while editing a [Text] block.

Display code	%Tbbbeee%
---------------------	-----------

Item	Description
T	Indicates that this is a Date/Time variable data table.
bbb	Displays the "Table No." setting (000 to 063).
eee	Displays the "Type" settings as follows. 000 = Month, 001 = Date, 002 = Hour, 003 = Minute, 004 = Week day, 005 = Week, 006 = Period

Link

The display code will be as follows when set by selecting the [Link] tab in the [Edit] dialog box while editing a [Text] block.

Display code	%Bffff%
---------------------	---------

Item	Description
B	Indicates that this is a link.
ffff	Displays the "Linked block number" setting (0000 to 2047).

Control code

The display code will be as follows when set by selecting the [Control code] tab in the [Edit] dialog box while editing a [Text] block.

Display code	%xgg%
---------------------	-------

Item	Description
x	Indicates that this is a control code.
gg	Displays the "Control code" setting.*

* Numeric values in gg will be displayed as shown in the table below.

Control code	Display code	Control code	Display code	Control code	Display code
NUL	00	VT	0B	SYN	16
SOH	01	FF	0C	ETB	17
STX	02	CR	0D	CAN	18
ETX	03	SO	0E	EM	19
EOT	04	SI	0F	SUB	1A
ENQ	05	DLE	10	ESC	1B
ACK	06	DC1	11	FS	1C
BEL	07	DC2	12	GS	1D
BS	08	DC3	13	RS	1E
HT	09	DC4	14	US	1F
LF	0A	NAK	15	DEL	7F

A.7 GS1 Code AI List

When [GS1 Databar] or [GS1 Data Matrix] are selected as [Code type] in the [ID code] block, this product can insert the following AI. The type of AI that can be inserted differs depending on the [Class] settings.

Category	AI	Identifier	GS1 Databar	GS1 DataMatrix
Identificati on No.	GTIN	01	Omni:Yes Truncated:Yes Limited:Yes Expanded:Yes	Ecc200 Square:Yes Ecc200 Rectangular:Yes
	Batch / Lot No.	10	Omni:No Truncated:No Limited:No Expanded:Yes	
	Renewal product / Specification change	20		
	Serial No.	21		
	Added product identification No.	240		
	Customer product No.	241		
	Original product / Raw materials	251		
	Customer order No.	400		
	GINC	401		
	GSIN	402		
	GLN (Shipping destination, delivery site)	410		
	GLN (Billing destination, billing address)	411		
	GLN (Product supplier)	412		
	GLN (Delivery site)	413		
	GLN (Logistics identifier)	414		
	GLN (Invoice created by)	415		
	Addressee zip code	420		
	ISO country code and addressee zip code	421		
	NATO stock No.	7001		
	Abattoir facility / Processing facility	703n		
	Mobile phone continuous No.	8002		
	GRAI	8003		
	GIAI	8004		
Component management No.	8006			
Recipient GSRN	8018			
Price	Measuring product amount (each currency)	392x		
	Measuring product amount (ISO currency code)	393x		
	Unit price	8005		
Size	Roll-product information	8001		
Y/M/D	Manufacturing Y/M/D	11		
	Payment due date	12		
	Expiration date	17		
Other	SSCC	00		
	Tracking code	403		
	Country of manufacture code	422		

Index

@Escape 2-50

Numerics

1-dot resolution 2-99
2D code 1-31

A

Acquire error command 8-16
Alarm 7-11
Arc block 1-33, 2-90
Arc radius 2-23
Aspect ratio 2-98

B

Backing Up 7-15
Bar code 1-31
Bar width 2-45
Bar width ratio 2-46
Base 2-36
Baud rate 6-5
Block 1-18
Block list 5-13
Block list command 8-38
Block menu 2-7
Block parameter acquisition command 8-28
Block parameter setting command 8-27

C

Calculate marking time 5-49
Call back command 8-65
Cancel error command 8-16
Cancelling the error 4-14
Cancelling the time hold setting 5-48
Cell 1-25
Cell array 2-132
Cell count-up direction 2-132
Cell height 2-52
Cell parameter acquisition command 8-26
Cell parameter setting command 8-25
Cell width 2-52
Change 2-133
Change lock 1-15
Changing index numbers 5-23
Changing the block number 5-16
Check code 6-5, 8-10
Check digit 2-46
Circle block 1-32, 2-82
Class 2-45

Clear history 4-11
Clearing the view 4-12
Clipping position 2-130
Close the shutter command 8-47
Code type 2-43
Code128 2-49
Code39 2-48
Codabar (NW-7) 2-46
Coefficient 2-29, 2-59
Comma 2-36
Command/response data 8-10, 9-5
Communication mode 6-5
Communication monitor 4-12
Communication procedure 8-12
Communication type to monitor 4-12
Communications 10-6
Connector Specifications 8-4
Content 2-37, 2-39, 2-40
Continuous count 2-109
Control code 2-40, 2-50, 2-54
Coordinate 2-3
Coordinate correct 2-110
Coordinate X/Coordinate Y 2-23, 2-85, 2-92
Correct layer position 2-111
Correction 2-45, 2-46
Correction level 2-52
Count 2-24, 2-73, 3-4
Count end action 5-47
Count end output 5-47
Count timing 5-47
Count up command 8-42
Counter 2-18, 5-45
Counter monitor 4-10
Counter No. 2-35, 5-46
Counter reset command 8-42
Counter setting acquisition command 8-41
Counter setting command 8-40
Counter status acquisition command 8-43
Counter text 2-36
Creating new marking data 2-12
Current date/time 2-7, 4-3
Current value 5-46

D

Data bit length 6-6
Data Exchange with EtherNet/IP/TM 10-3
Data install 1-10
Data Matrix 2-54
Date setting 1-15
Data table number 5-17
Date time table tab 2-17
Date/Time 2-33
Date/time acquisition command 8-62
Date/time offset 2-32, 2-38

Date/time setting	6-10
Date/time setting command	8-62
Date/time variable data table	5-30
Default value	6-14
Deform	2-103
Deleting the block	5-14
Device status acquisition command	8-48
DFL	1-26, 2-118, 2-121
Digit	2-34, 2-36
Dir.	2-25, 2-73
Direction	2-109
Display codes	A-23
Divided by	2-85
Do not use start/end edit command	6-6
Dot count	2-99
Dot direction	2-99

E

EAN (JAN) -13	2-45
EAN (JAN) -8	2-45
Edit mode	1-14
Edit mode screen	2-7
Edit mode shift	6-12
Edit point	11-24
Editing the marking data	2-12
EE mode	6-24
Enable counter	5-46
Enable warm-up	1-16
End code	6-5
End code bytes	6-5
End edit command	8-17
End point X/End point Y	2-72
End signal in continuity	2-109
End value	5-46
Enlarging/shrinking the block	2-10
Error history	4-11
Error status display area	4-4
EtherNet	10-2
Ethernet port	9-3
EtherNet/IPTM	10-2
External trigger	3-6

F

File data transfer command	8-52
Fill dark module	2-57
Fill direction	2-25, 2-56
Fill light module	2-57
Fill margin	2-26
Fill method	2-25
Fill spacing	2-26, 2-56
Fixed point block	1-31, 2-66
Fixed position	2-22
Focus pointer	7-3
Font	2-20, 2-104
Font Logo Editor	
Common properties area	11-9
Drawing area	11-9

Drawing tool	11-9
Edit menu	11-13
Ending	11-7
File menu	11-12
Font mode	11-2
Glyph	11-29
Help menu	11-28
Insert menu	11-18
Load data	11-4
Load data tool	11-9
Load model	11-4
Load model area	11-9
Logo mode	11-3
Menu bar	11-8
Object list	11-9
Pattern mode	11-3
Properties area	11-9
Selection tool	11-9
Setting menu	11-26
Specifying the stroke order	11-5
Starting	5-50, 11-6
Title bar	11-8
Tool menu	11-21
Toolbar	11-8
View menu	11-16
Format	2-34
Formatting to bold	2-24
Frequency	2-29, 2-115
Function mask setting	6-12

G

G-DAC	2-28
Graphic block	1-34, 2-101, 5-22
Grid	5-3, 6-9
Group of blocks	2-10
Group property	2-11
Grouping the blocks	2-10
GS1	2-51, 2-55
Guide laser acquisition command	8-47
Guide laser setting command	8-46
Guide line	5-4

H

Halftone	2-98
Handle	2-9
Handle snap	5-6
Height	2-56, 2-78, 2-130

I

I/O monitor	4-13
I/O setting	6-2
ID code block	1-31, 2-41
Image block	1-33, 2-96, 5-22
Index number	5-17
Initial timing	5-46
Initial value	5-46

Input error output	6-3
Input signal confirmation time	6-3
Intersection removal	2-27
Interval	2-109
Interval set method	2-109
Interval X/Interval Y	2-131
Invert black and white	2-45, 2-99
Item to load	2-104
ITF	2-47

L

Language setting	6-15
Laser mode	3-5, 4-7
Laser mode selection and Marking start/stop operation area 4-4	
Laser OFF time	2-68
Laser ON time	2-68
Laser power	7-4
Laser power check settings	6-6
Laser pwr chk.	6-7
Laser/Scan settings for each block	5-15
Layer	1-19, 5-9
Layer count	2-111
Layer creation	5-9
Lead-on distance	2-31, 2-117
Length	2-72, 2-84
Line block	1-32, 2-70
Line shift	2-80, 2-87
Line skip	2-26, 2-57
Line spacing	2-21, 2-27
Line type	2-72, 2-84
Link function	2-62
Linked block number	2-39
Load model	11-25
Lock button	4-5
Lock setting	5-7

M

Maintenance/adjustment	6-12
Marker operation setting	6-12
Marker software	1-2
Marking area	2-6
Marking control	2-109
Marking data	1-17
Marking data information acquisition command	8-37
Marking data information display area	2-8, 4-4
Marking data list command	8-36
Marking data lock	6-12
Marking data No. acquisition command	8-45
Marking data No. specification command	8-44
Marking direction	2-5, 2-109
Marking end output	6-3
Marking end refresh control	6-4
Marking operation history	4-11
Marking parameter acquisition command	8-20
Marking parameter setting command	8-18
Marking ready display area	4-3

Marking setting area	2-8
Marking start command	8-48
Marking stop	8-48
Marking stop error control	6-3
Marking trigger input	6-3
Menu bar	2-7, 4-3
Message format	8-9
Method	2-110
Mirror flip	2-23, 2-24, 2-56, 2-93, 2-110
Mode	1-15
Monitoring error status	4-14
Monitoring marking status	4-9
Moving speed	2-30, 2-117
Moving the block	2-9

N

No font space	2-21
No zero suppression	2-34, 2-36
Node number	6-5
Non-marking cells	2-132
Non-marking target setting	5-7
Number X/Number Y	2-131

O

OFF delay	2-31, 2-117
Offline editing software	1-2, 1-13
Offset	7-3
ON delay	2-31, 2-117
Open angle	2-23, 2-93
Open the Shutter command	8-47
Operation limit setting	6-11
Operation mode	1-14
Optimization	2-110
Optimized speed	2-27, 2-132
Optimized speed 2	2-58
Output type	5-47

P

Pallet	1-25, 2-125
Pallet parameter acquisition command	8-24
Pallet parameter setting command	8-22
Parity	6-6
Part file	1-34, 2-106, 5-12
Password	6-11
Pattern	7-3
Position	2-23, 2-56, 2-68, 2-72, 2-85, 2-99, 2-104, 2-111
Position correction	2-5
Position (Form/Pos)	2-92
Position X/Position Y	2-132
Power	2-115
Processing speed	2-30, 2-116
Profile marking	2-26, 2-79, 2-87
Pulse output signal width	6-3
Pulse shape	2-30, 2-116

Q

Quiet zone 2-45

R

Radius X/Radius Y 2-85, 2-92
 Rectangle block 1-32, 2-75
 Reference point 2-5
 Repeat count 2-28
 Restoring 7-16
 Rotating the block 2-9
 Rotation angle 2-23, 2-24, 2-56, 2-78, 2-85, 2-93, 2-130
 RS-232C/RS-422A serial port 8-4
 Ruler 5-3
 Runup distance 2-31, 2-117
 Runup enable angle 2-31, 2-117

S

Save 2-134
 Save as 2-134
 Save edited data command 8-17
 Save logo style 11-28
 Saving to USB memory 1-6
 Scan speed 3-4
 Screen mode selection area 2-7, 4-3
 Select layer diag 2-111
 Sensor correction 7-6
 Serial communication setting 6-4
 Serial communication specifications 8-3
 Set angle 2-26
 Set blocks 3-5
 Set cells 3-5
 Setting the period 5-33
 Sheet 1-18, 2-8, 4-3
 Shift to right/Shift to left 2-33, 2-35
 Shutter external command control 6-3
 Smooth 2-99
 Smoothing 2-28
 Snap interval 6-9
 Sorting the blocks displayed 5-14
 Space 2-72, 2-84
 Specify by 2-132
 Specify marking data 1-15
 Speed coefficient 2-26, 2-79, 2-87
 Start angle 2-23, 2-92
 Start code 6-5
 Start edit command 8-17
 Start setting 1-15, 6-9
 Start/stop marking 6-12
 Starting point X/Starting point Y 2-72, 2-78, 2-130, 2-131
 Starting/stopping monitoring 4-12, 4-13
 Status display area 4-4
 Step 5-46
 Stop bit length 6-6
 Stroke order 11-22
 Switching layer 5-11
 Switching the Selected Block 2-10

Symbol size 2-54

T

Table No. 2-37, 2-38
 Test marking 1-14, 3-2
 Text angle 2-22
 Text block 1-30, 2-14, 5-20
 Text direction 2-22
 Text height 2-21
 Text positioning 2-22
 Text spacing 2-21
 Text width 2-21
 Time 3-5
 Time hold 5-48
 Time hold monitor 4-10
 Time hold setting command 8-38
 Time hold status acquisition command 8-39
 Time setting (date/time setting) 6-10
 Tool bar 2-7
 Total height 2-23
 Total width 2-23
 Traceability log setting parameter acquisition 8-60, 8-61
 Traceability log setting parameter change 8-59
 Trigger delay 2-109
 Type 2-38, 3-4
 Type setting 1-5

U

Uninstallation 1-5
 Unit number 6-5
 USB memory 1-6

V

Variable data monitor 4-10
 Variable data table 5-17
 Variable data table index acquisition command 8-44
 Variable data table index specification command 8-44
 Version 2-52
 Version acquisition command 8-62
 Vertex angle 2-27
 Vertex removal 2-27
 Vertex wait effective angle 2-31
 Vertex wait time 2-30, 2-117
 Vertex wait time effective angle 2-117
 View manual 5-50
 View setting, block/layer switching area 2-8
 View setting/update image area 4-4
 View version 5-51

W

Wait time after moving 2-30, 2-117
 Warm up 7-7
 Warm up setting 1-16
 Warm-up start command 8-49
 Width 2-25, 2-56, 2-73, 2-78, 2-130

Z

Zoom in	5-2
Zoom out	5-2

Manual Revision History

The manual revision code is appended at the end of the control number printed at the bottom of the cover and back cover.

Cat. No. Z416-E1-08

↑
Revision code

Revision code	Revision date	Revision description
01	September, 2019	First version
02	June, 2020	Corrected Chapter10 "Operation and Control by EtherNet/IP™ Communication"
03	February, 2021	<ul style="list-style-type: none"> • Added command names to "Command List" in Chapter 10 "Operation and Control by EtherNet/IP™ Communication" • Corrected mistakes
04	June, 2021	<ul style="list-style-type: none"> • Added description about Power ON to "Traceability Log Settings" in Chapter 7 "Maintenance and Adjustment" • Corrected mistakes
05	February, 2022	Corrected mistakes
06	April, 2022	Corrected mistakes
07	October, 2022	Added safety precautions regarding security
08	November, 2022	Standard label change

OMRON Corporation Industrial Automation Company

Kyoto, JAPAN

Contact : www.ia.omron.com

Regional Headquarters

OMRON EUROPE B.V.

Wegalaan 67-69, 2132 JD Hoofddorp
The Netherlands
Tel: (31) 2356-81-300 Fax: (31) 2356-81-388

OMRON ELECTRONICS LLC

2895 Greenspoint Parkway, Suite 200
Hoffman Estates, IL 60169 U.S.A.
Tel: (1) 847-843-7900 Fax: (1) 847-843-7787

OMRON ASIA PACIFIC PTE. LTD.

438B Alexandra Road, #08-01/02 Alexandra
Technopark, Singapore 119968
Tel: (65) 6835-3011 Fax: (65) 6835-2711

OMRON (CHINA) CO., LTD.

Room 2211, Bank of China Tower,
200 Yin Cheng Zhong Road,
PuDong New Area, Shanghai, 200120, China
Tel: (86) 21-5037-2222 Fax: (86) 21-5037-2200

Authorized Distributor:

©OMRON Corporation 2019-2022 All Rights Reserved.
In the interest of product improvement,
specifications are subject to change without notice.

Cat. No. Z416-E1-08 1122